

eduard  
MASK

CX 166

# F-16A Fighting Falcon 1/72

The die-cut mask for accurate canopy frame painting of the  
*Hasegawa* scale 1/72 KIT

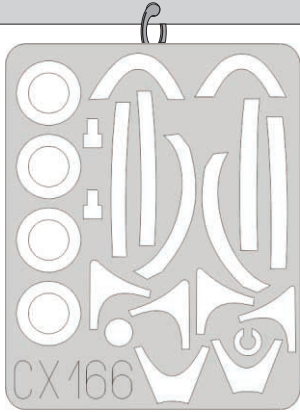

B12  
2pcs.

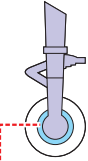
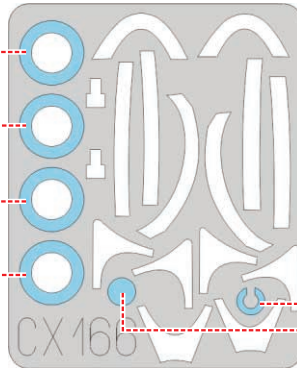
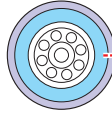

C6

B12  
2pcs.

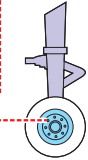
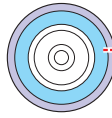

C6



LIQUID MASK ■

B12  
2pcs.

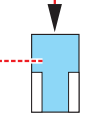
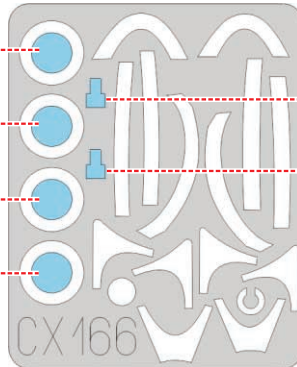
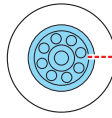

E3  
2pcs.

B12  
2pcs.

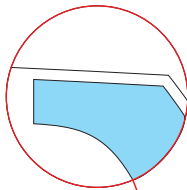
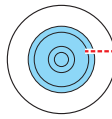

1.)

E1

E2

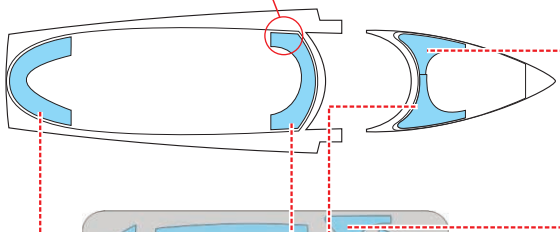

3.)



INTERIOR COLOR

4.)



RUBBER COLOR

E1

E2

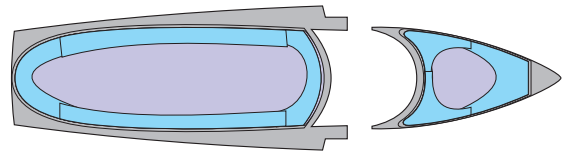

LIQUID MASK ■

2.)

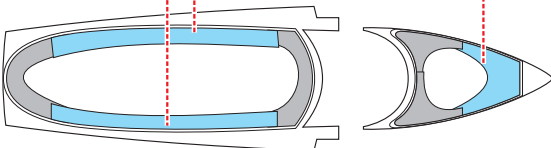

5.)

REMOVE MASK

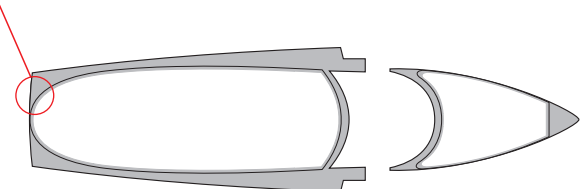

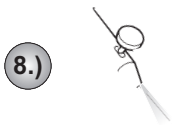
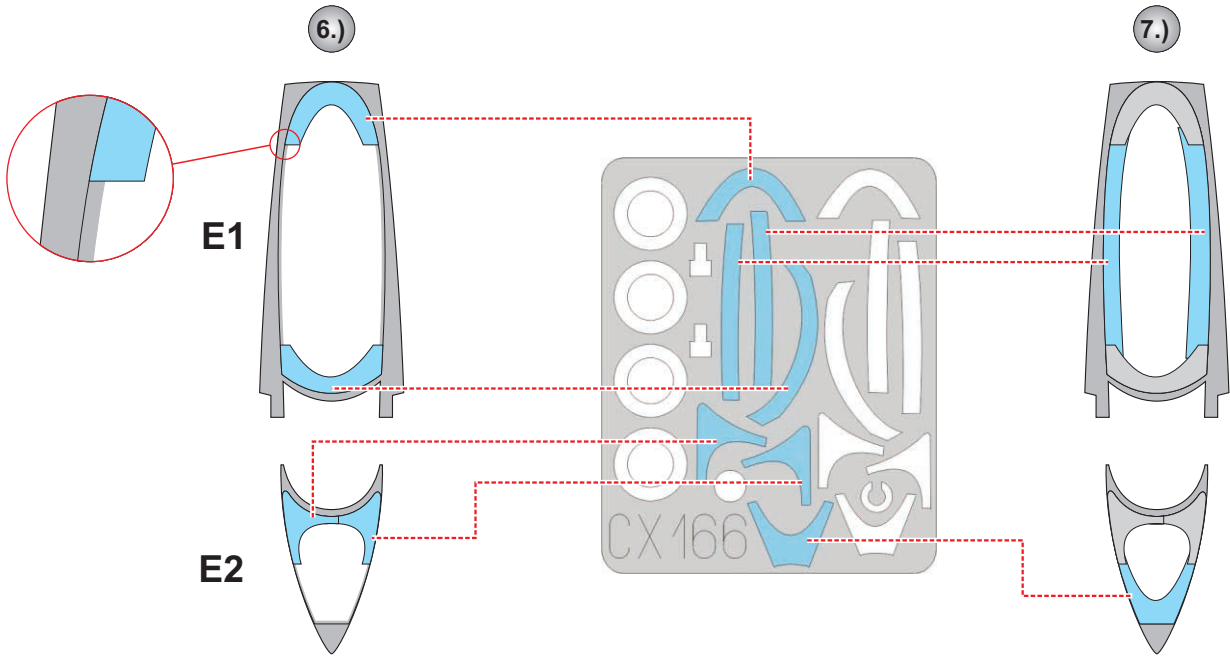

8.)

### CAMOUFLAGE COLOR

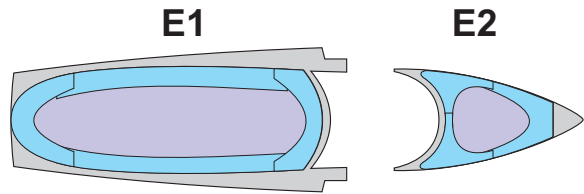

LIQUID MASK ■

9.)

### REMOVE MASK

