

BAC Lightning F.Mk.53

Saudi Silver



Visit to www.uprise-decal.ru for more Saudi BAC Lightnings

BAC Lightning F.Mk.53

Saudi CAMO

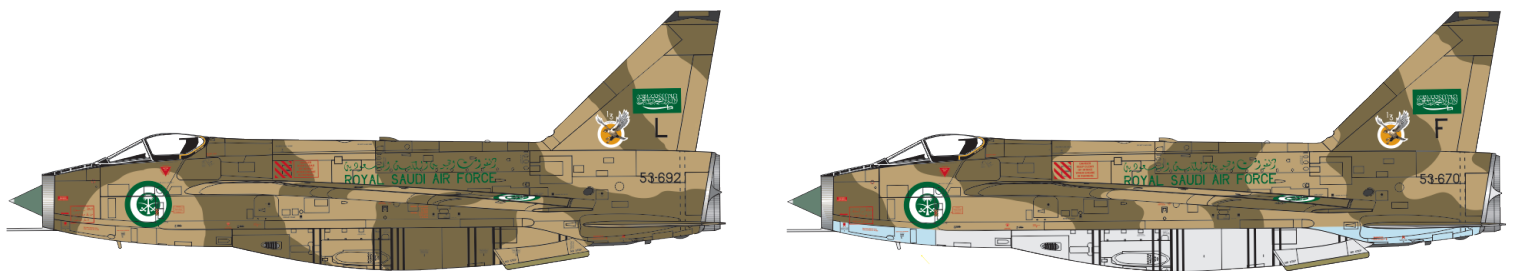

...and F.Mk.52 & T.Mk.55 soon



A. BAC Lightning F.Mk.53.

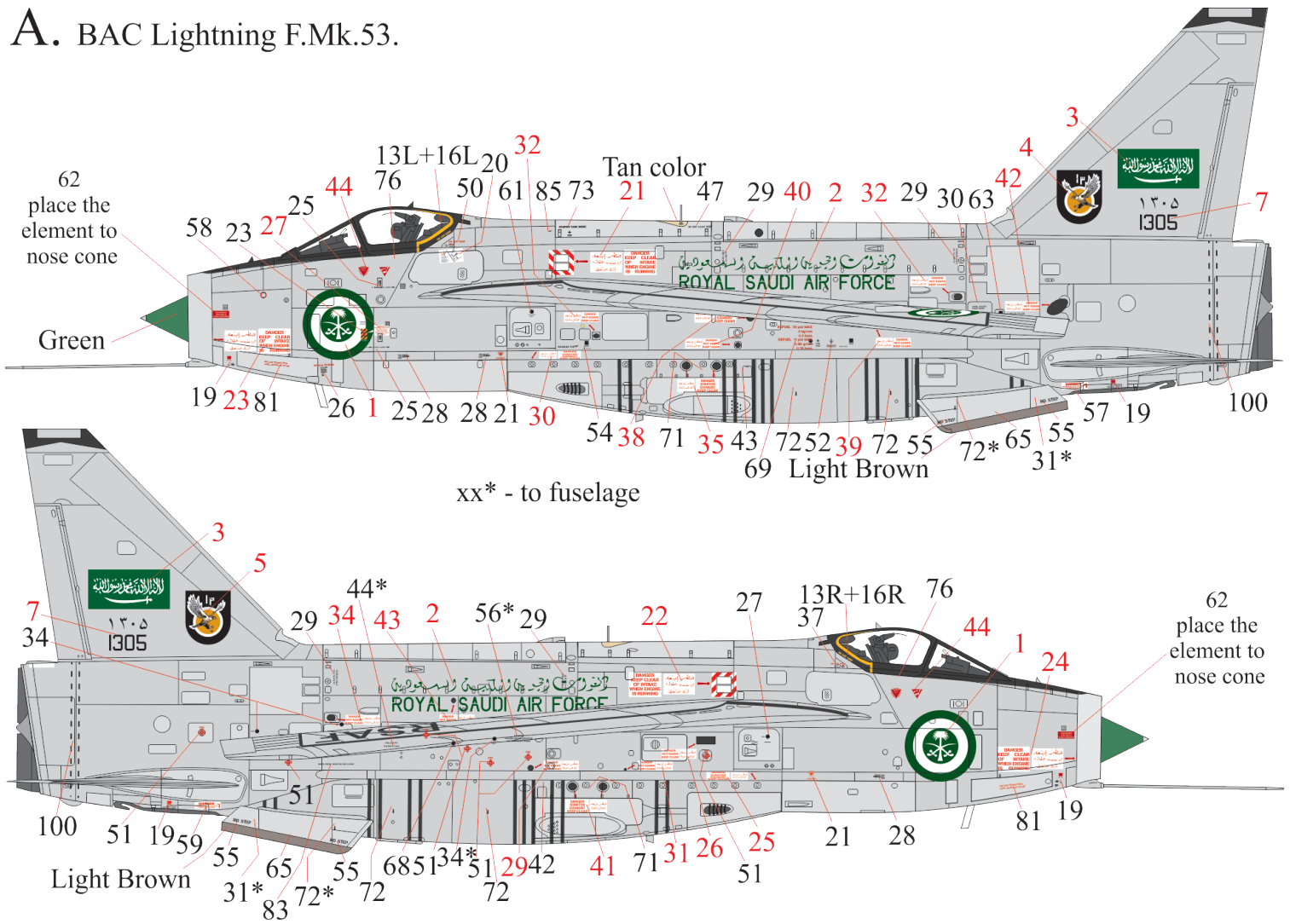

B. BAC Lightning F.Mk.53.

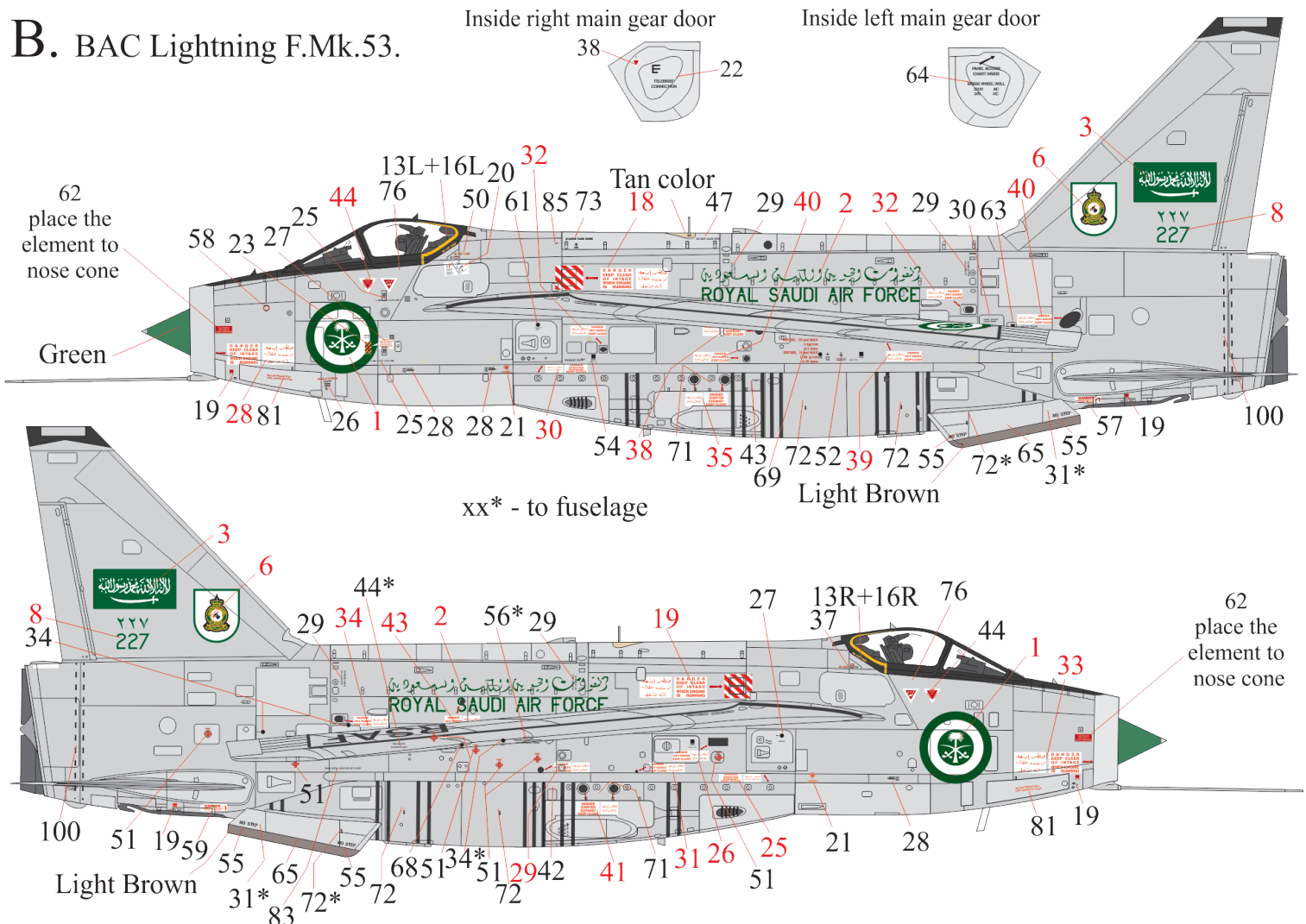

C. BAC Lightning F.Mk.6, it's RAF aircraft that was temporary painted as Saudi for Farnborough exhibition.

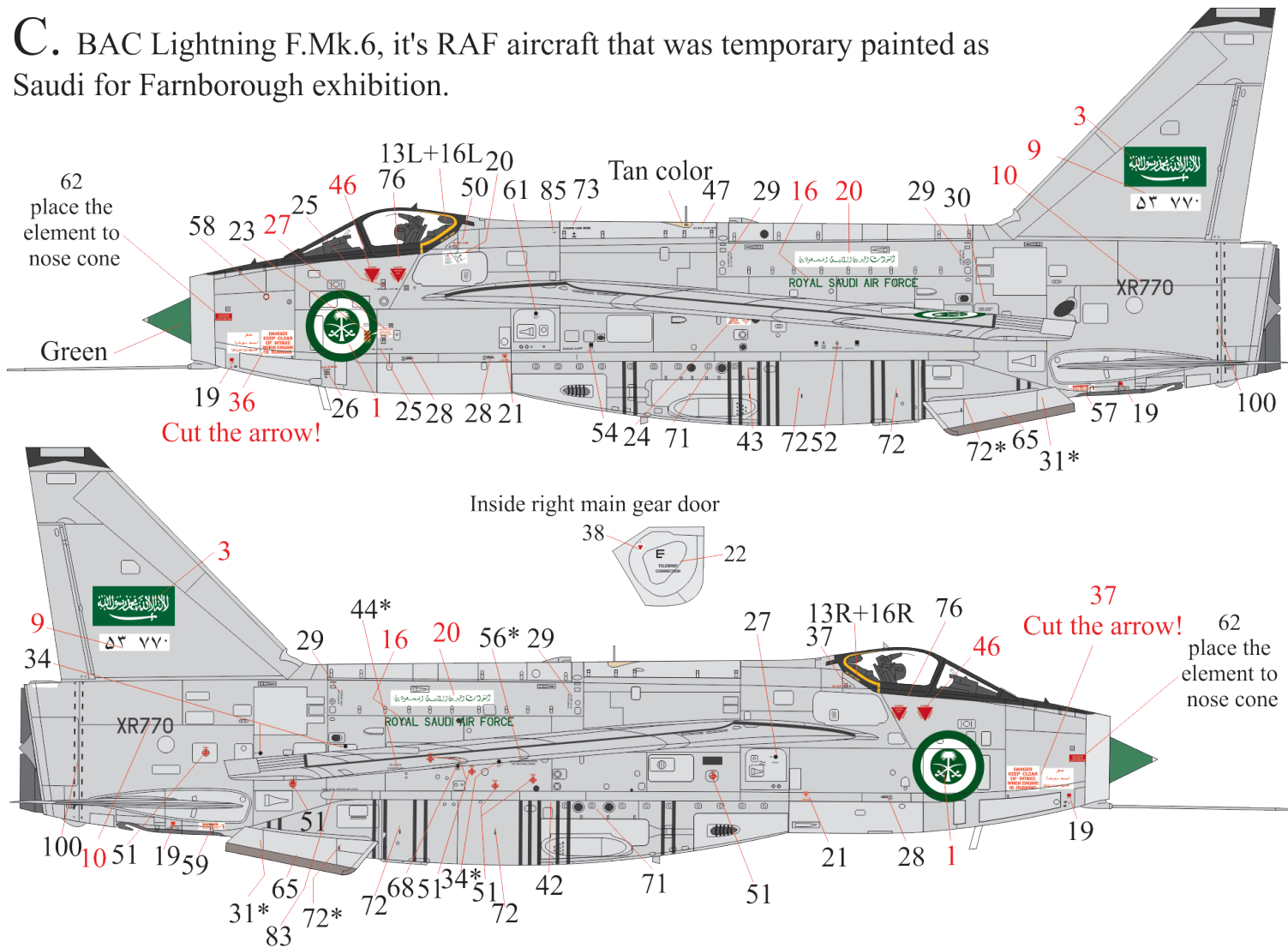

D. BAC Lightning F.Mk.53, the first delivered to RSAF. Inside left main gear door

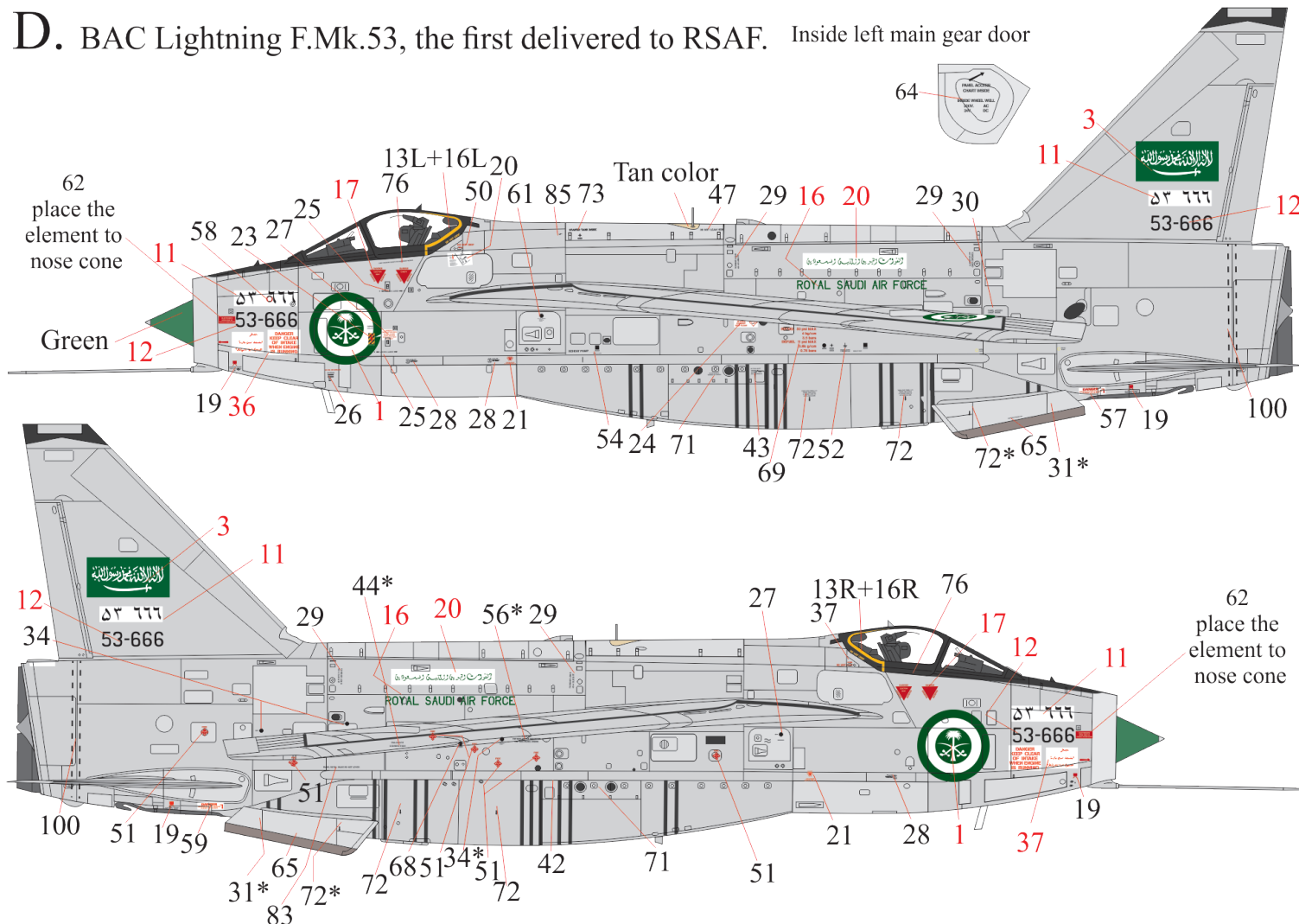

A/B/D top view

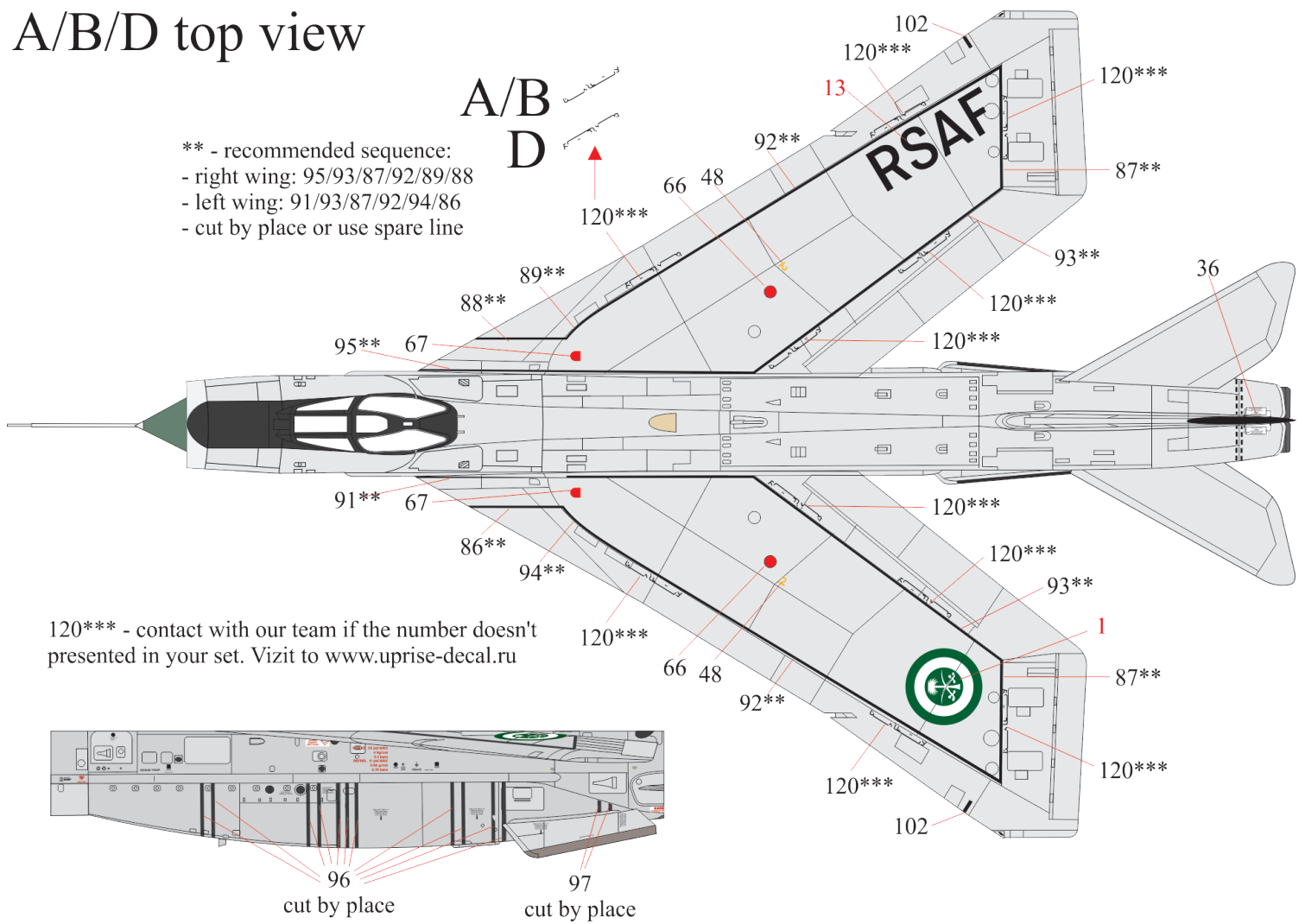

A/B/D bottom view

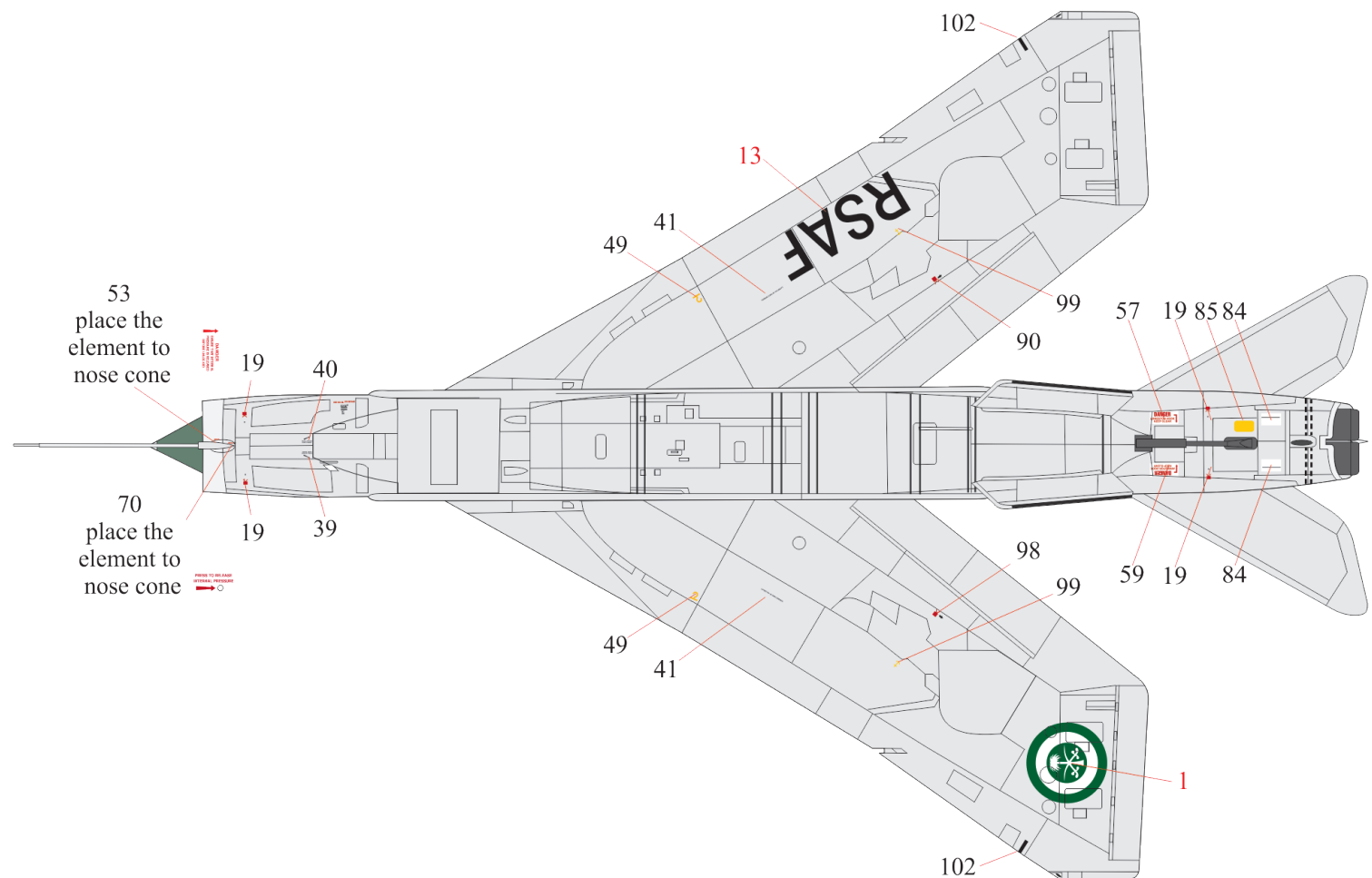

C top view

** - recommended sequence:
 - right wing: 95/93/87/92/89/88
 - left wing: 91/93/87/92/94/86
 - cut by place or use spare line

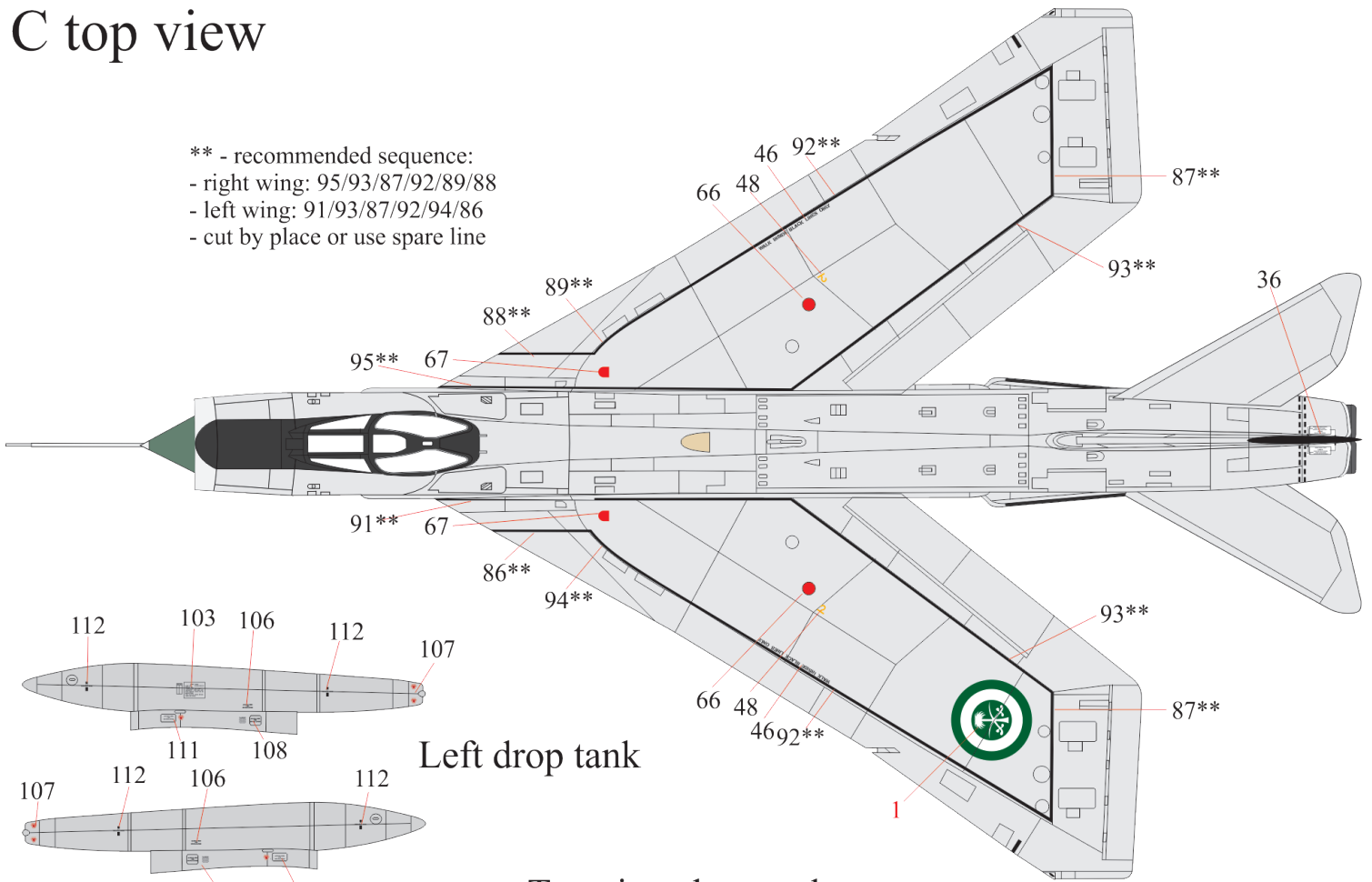

Left drop tank

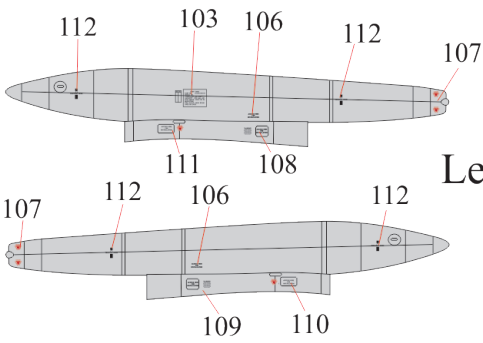

Top view drop tank

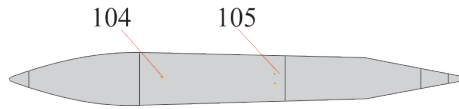

C bottom view

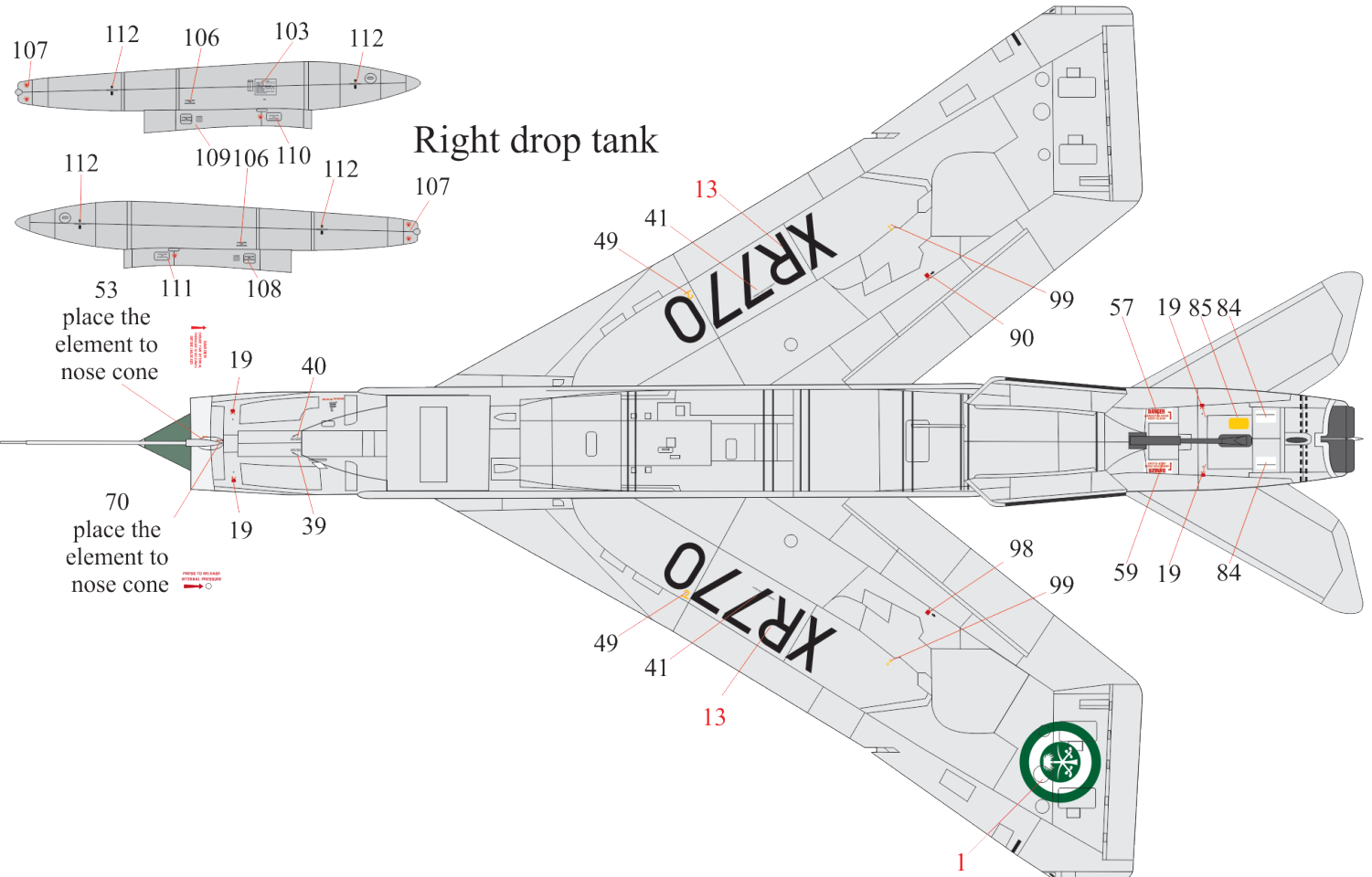

Right drop tank

