

KC-135R

STRATOTANKER



**16 MARKING OPTIONS
FOR USAF STRATOTANKERS**

1/144 SCALE

DECALS PRINTED BY



OPTION 10: KC-135R 60-0345
127 WING, MICHIGAN ANG



OPTION 10 IS THE ONLY KC-135 ON THIS SHEET WITH NON-STANDARD FUSELAGE MARKINGS, AND HAS BEEN CHOSEN TO PROVIDE AN OVERALL VIEW OF THE FUSELAGE HERE. ALL OTHER OPTIONS ARE REPRESENTED WITH PARTIAL NOSE AND TAIL MARKINGS ONLY - THEY HAVE NO OTHER MARKINGS ON THE FUSELAGE. FOR EXACT PLACEMENT OF STENCILS AND DOOR MARKINGS, REFER TO THE STENCILLING SECTION ON THE LAST FOUR PAGES.

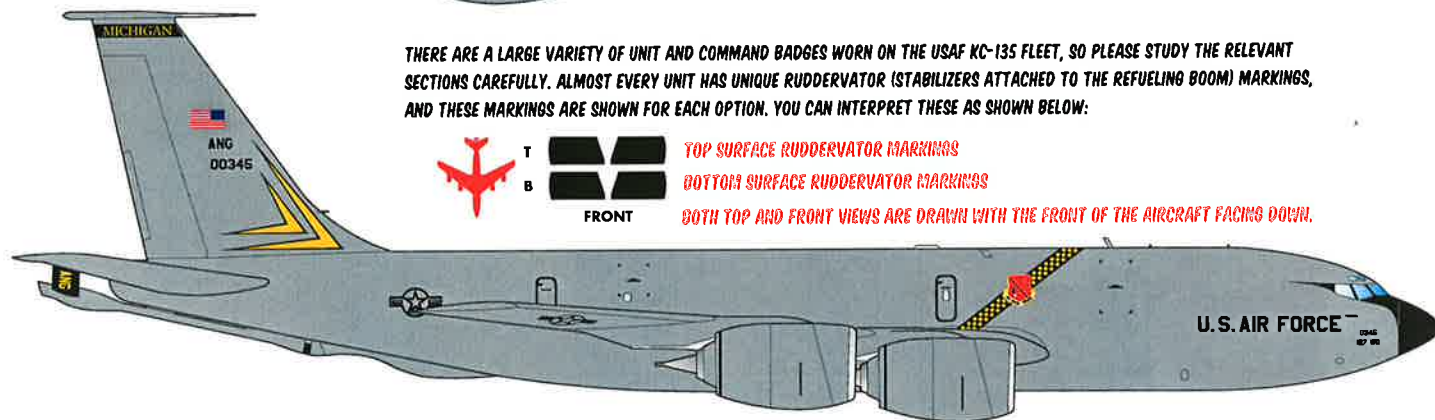
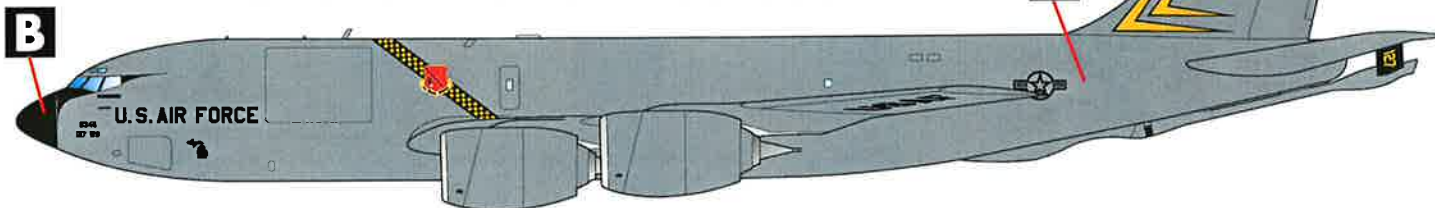

THERE ARE A LARGE VARIETY OF UNIT AND COMMAND BADGES WORN ON THE USAF KC-135 FLEET, SO PLEASE STUDY THE RELEVANT SECTIONS CAREFULLY. ALMOST EVERY UNIT HAS UNIQUE RUDDERVATOR (STABILIZERS ATTACHED TO THE REFUELING BOOM) MARKINGS, AND THESE MARKINGS ARE SHOWN FOR EACH OPTION. YOU CAN INTERPRET THESE AS SHOWN BELOW:



TOP SURFACE RUDDERVATOR MARKINGS

BOTTOM SURFACE RUDDERVATOR MARKINGS

BOTH TOP AND FRONT VIEWS ARE DRAWN WITH THE FRONT OF THE AIRCRAFT FACING DOWN.

FOR OPTIONS WITH DECORATIVE TRIM AROUND THE NOSE AREA, PLEASE REFER TO THE REFERENCE PHOTOS AT:

[HTTP://WWW.CARACALMODELS.COM/REFERENCES/CD144001](http://www.caracalmodels.com/references/cd144001)

DO NOT APPLY WING WALKWAYS FROM THE KIT SHEET OR OTHER AFTERMARKET SHEETS.

WE KNOW THEY LOOK GOOD - BUT WING WALKWAYS HAVE NOT BEEN APPLIED TO THE USAF KC-135 FOR YEARS.

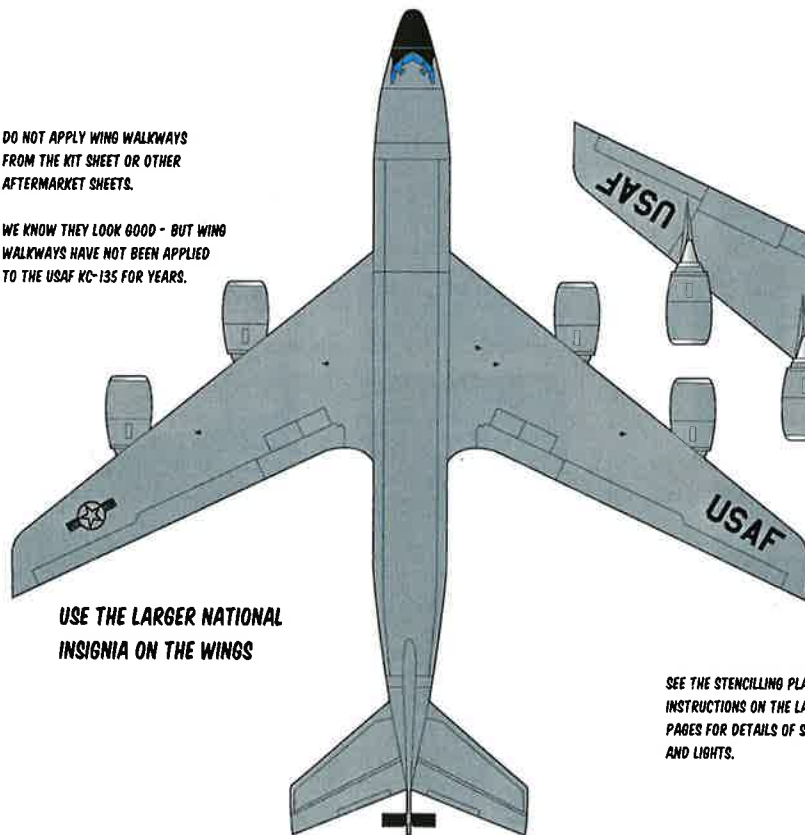

USE THE LARGER NATIONAL INSIGNIA ON THE WINGS

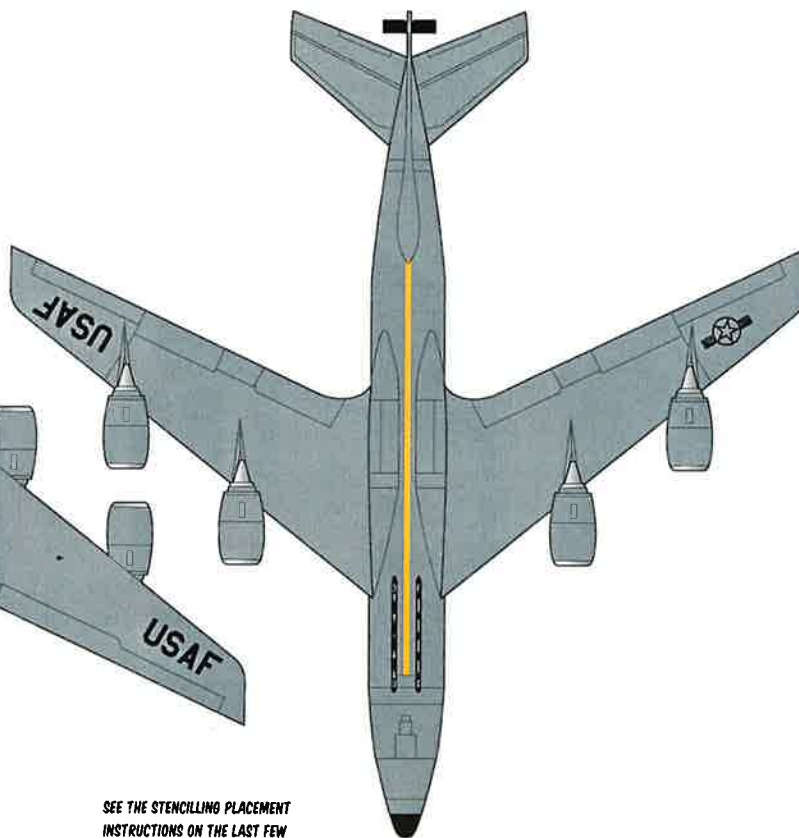

SEE THE STENCILLING PLACEMENT INSTRUCTIONS ON THE LAST FEW PAGES FOR DETAILS OF STENCILS AND LIGHTS.

OPTION 1: KC-135R 62-3516

161 ARW, ARIZONA ANG
2013

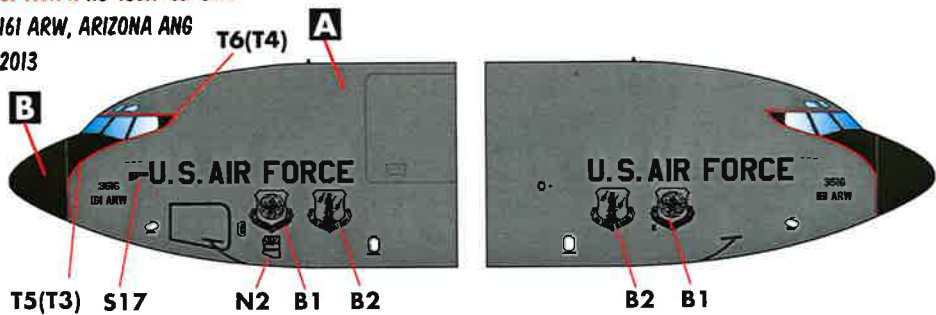

3516
161 ARW

3516
161 ARW

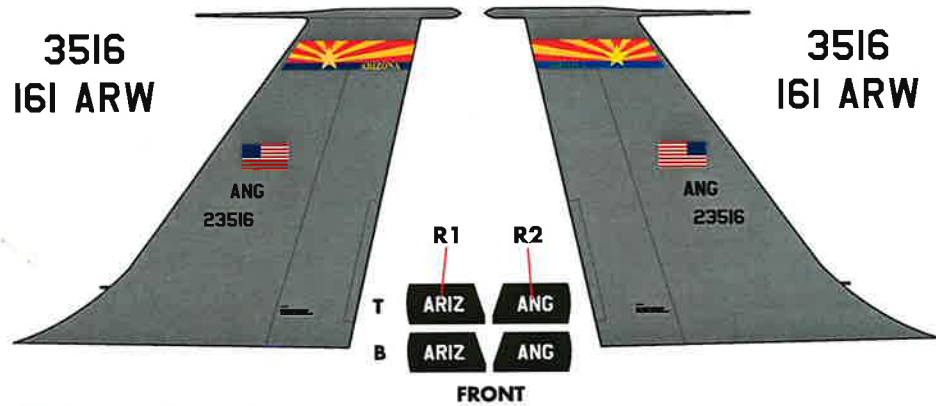

FRONT

OPTION 3: KC-135R 63-8872

101 ARW, MAINE ANG
2013

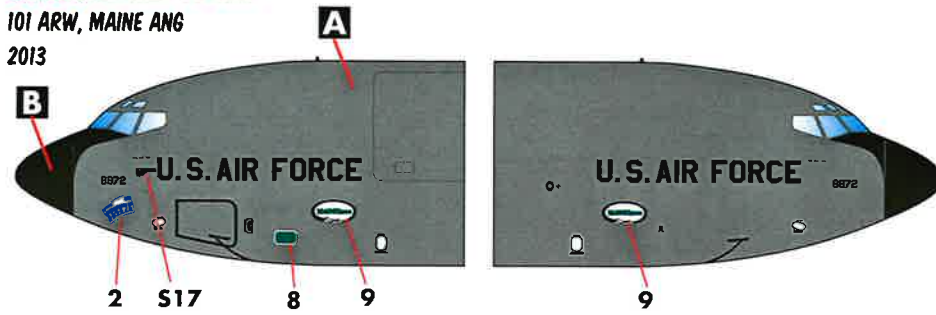

8872

8872

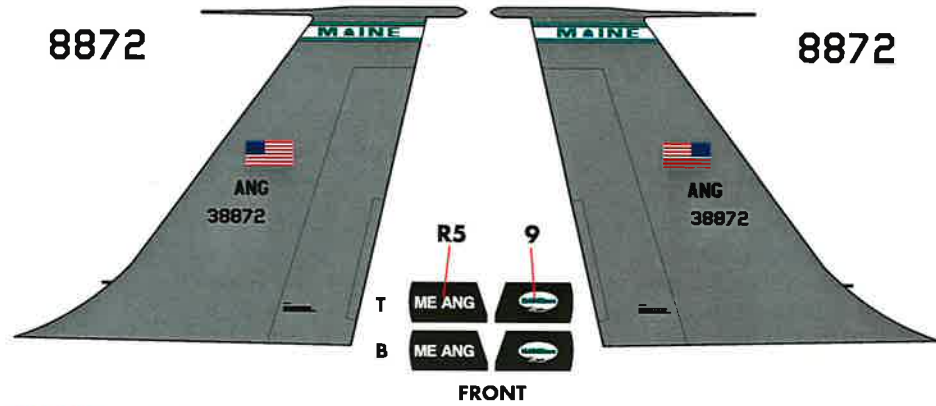

FRONT

OPTION 2: KC-135R 62-3576

157 ARW, NEW HAMPSHIRE ANG
2010

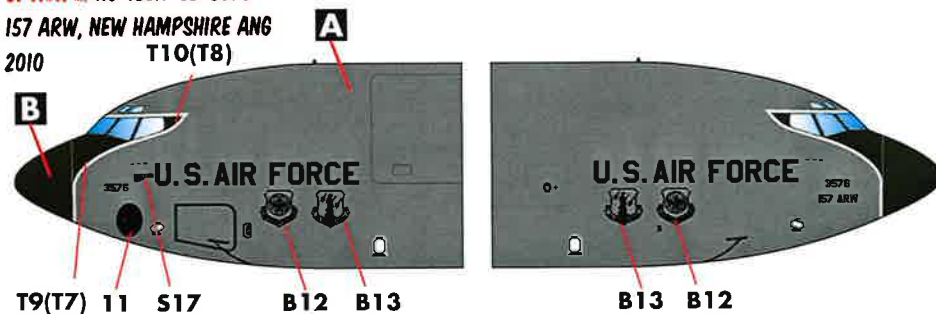

3576

3576
157 ARW

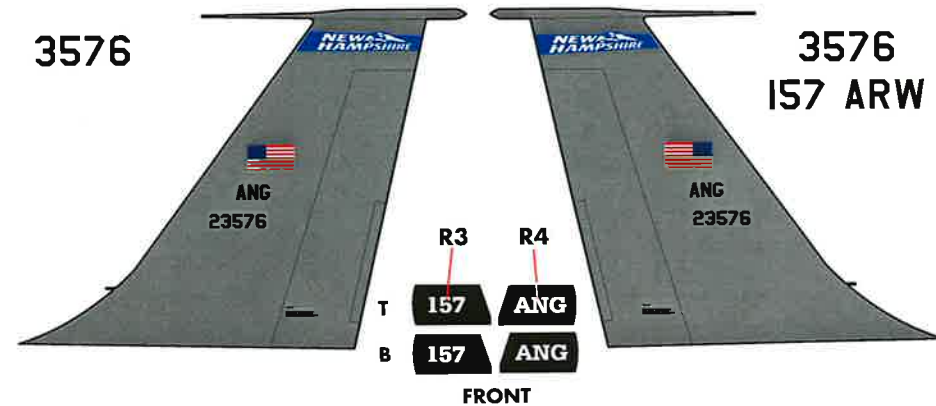

FRONT

OPTION 4: KC-135R 61-0305

97 AMW, AETC - ALTUS AFB
2013

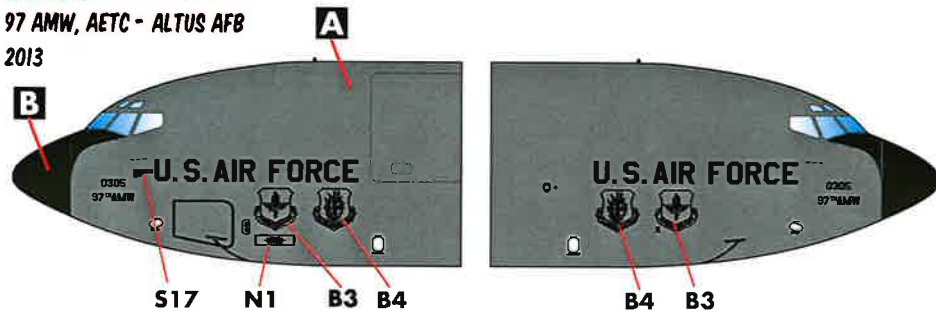

0305
97THAMW

0305
97THAMW

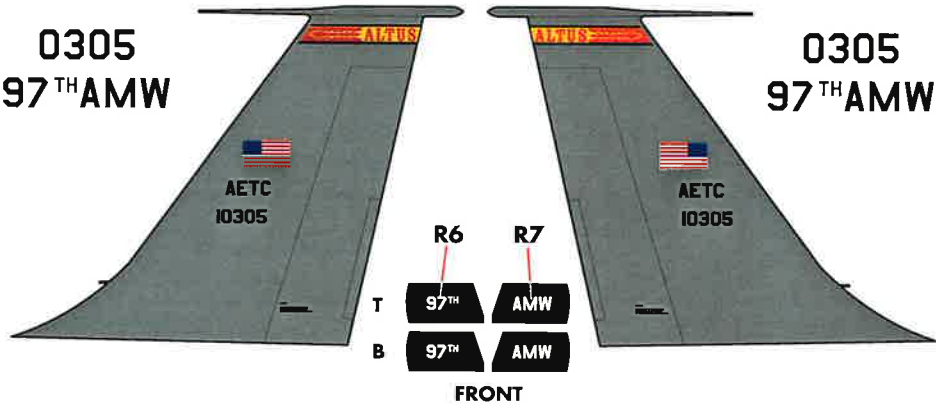

FRONT

OPTION 5: KC-135R 61-4840

121 ARW, OHIO ANG
2012

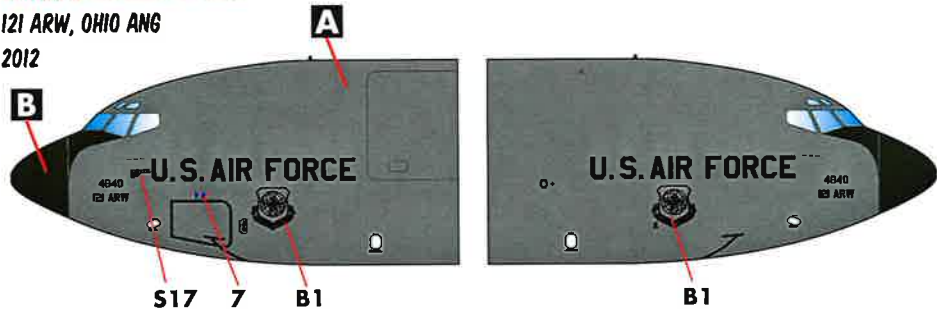

4840
121 ARW

4840
121 ARW

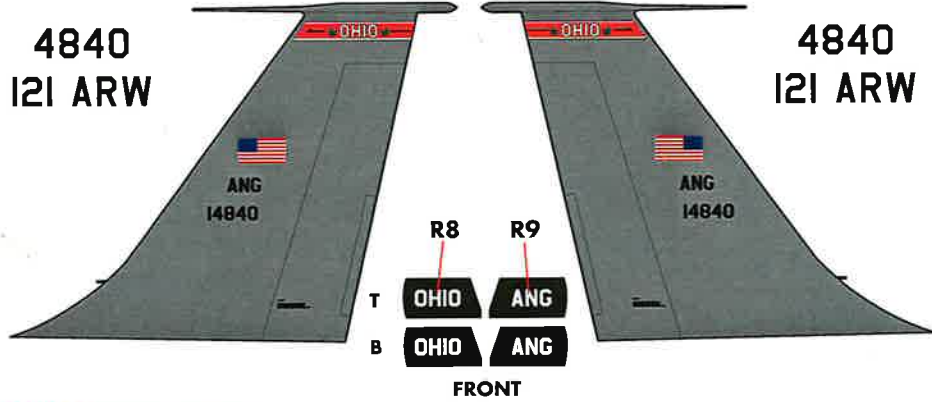

FRONT

OPTION 7: KC-135R 58-0001

100 ARW, USAF - RAF MILDENHALL
2013

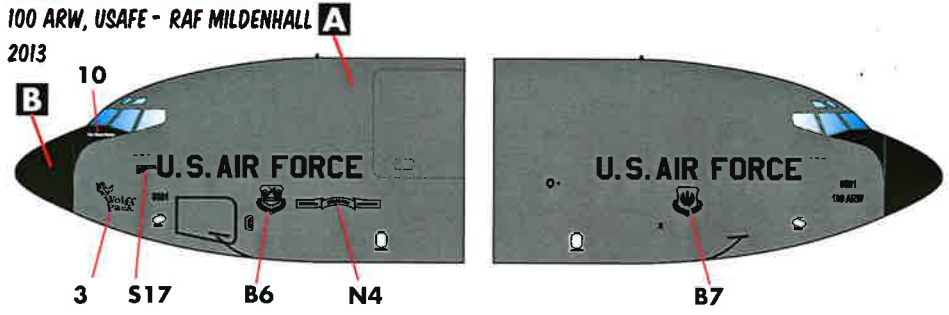

0001

0001
100 ARW

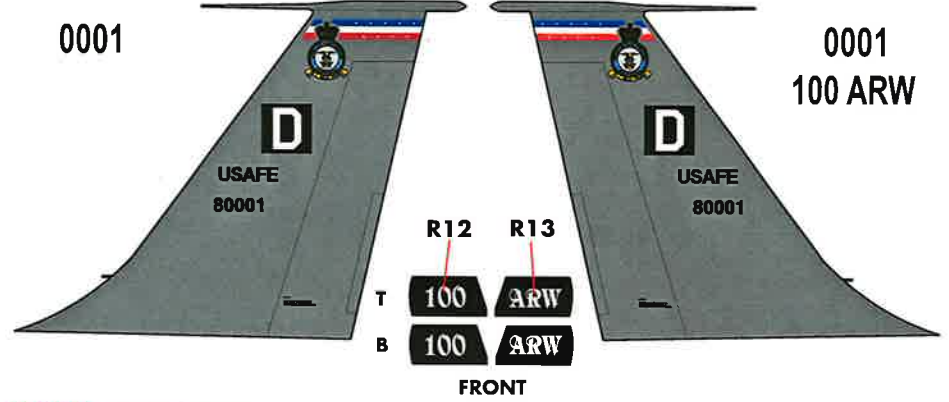

FRONT

OPTION 6: KC-135R 62-3543

459 ARW, AFRC - ANDREWS AFB
2012

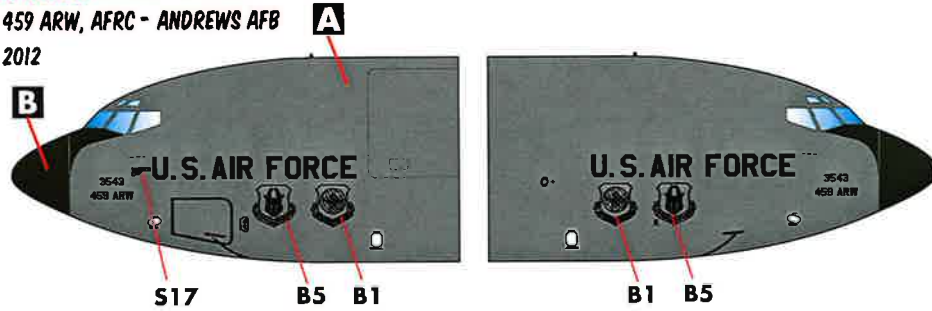

3543
459 ARW

3543
459 ARW

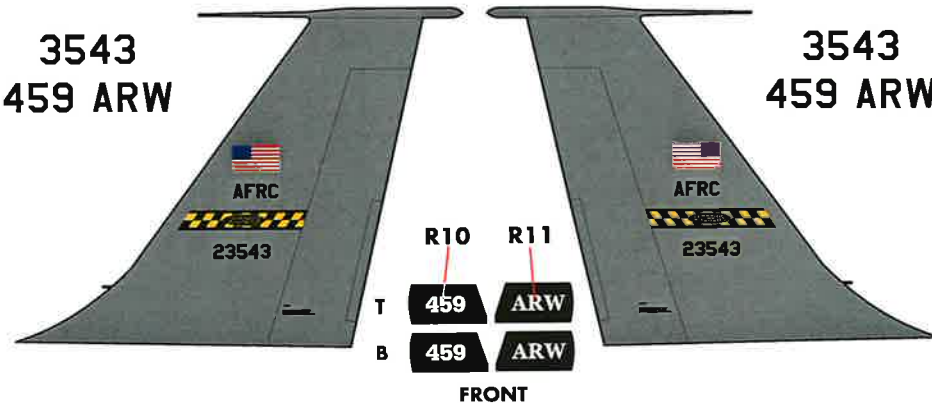

FRONT

OPTION 8: KC-135R 58-0102

434 ARW, AFRC - GRISSOM AFB
2005

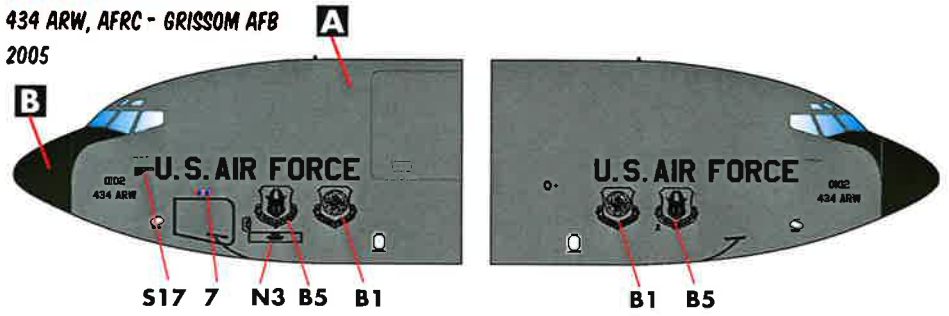

0102
434 ARW

0102
434 ARW

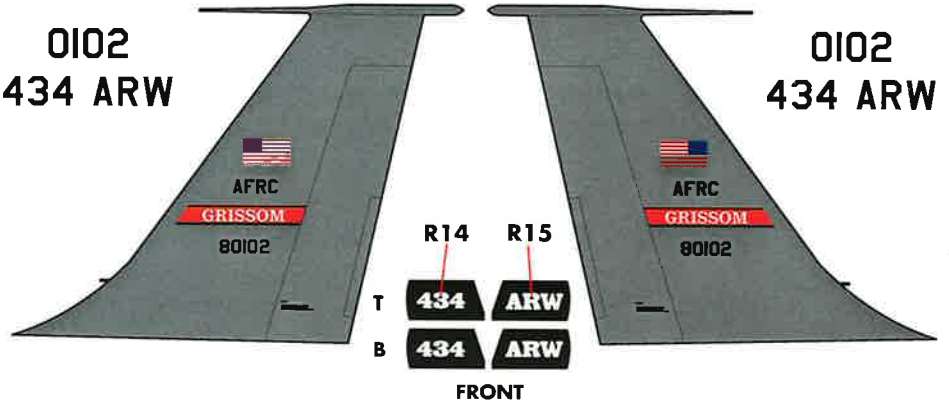

FRONT

OPTION 9: KC-135T 58-0065

22 ARW, AFRC - MC CONNELL AFB
2011

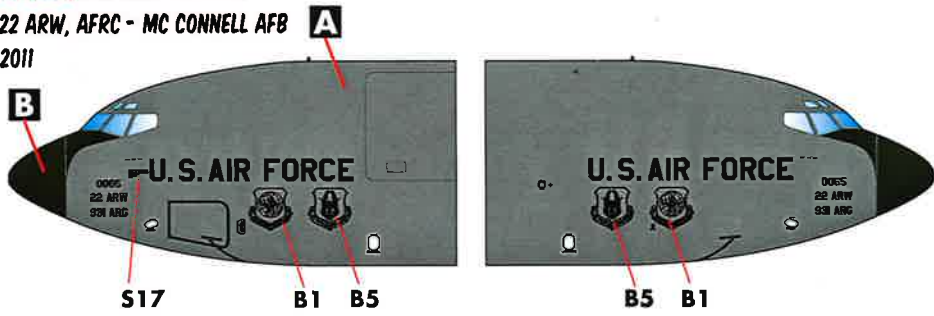

S17 B1 B5

0065
22 ARW
931 ARG

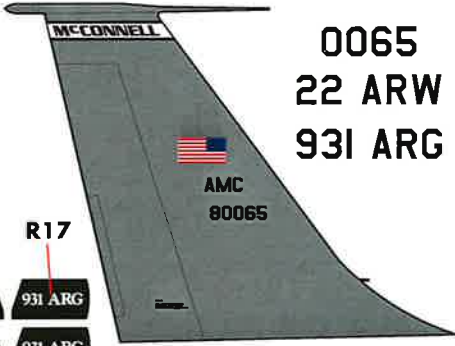
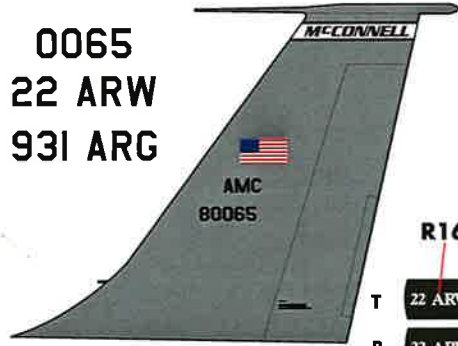

R16 R17
T 22 ARW 931 ARG
B 22 ARW 931 ARG

FRONT

OPTION 11: KC-135R 60-0318

154 WING, HAWAII ANG
2013

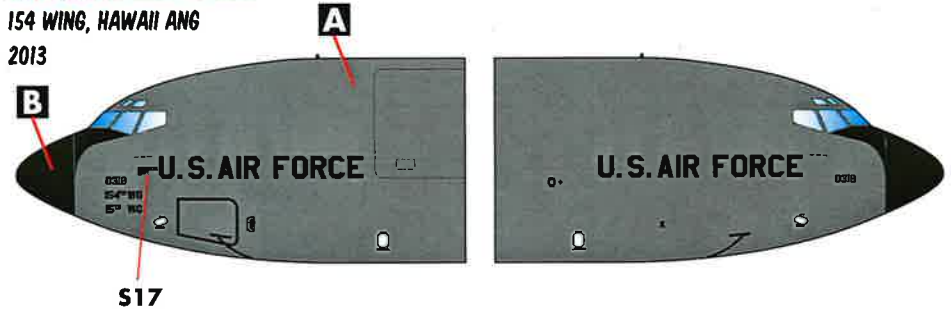

S17

0318
154TH WG
15TH WG



B11
T HAWAII ANG
B HAWAII ANG

FRONT

OPTION 10: KC-135R 60-0345

127 WING, MICHIGAN ANG
2012

SEE SIDE VIEW ON PAGE 2

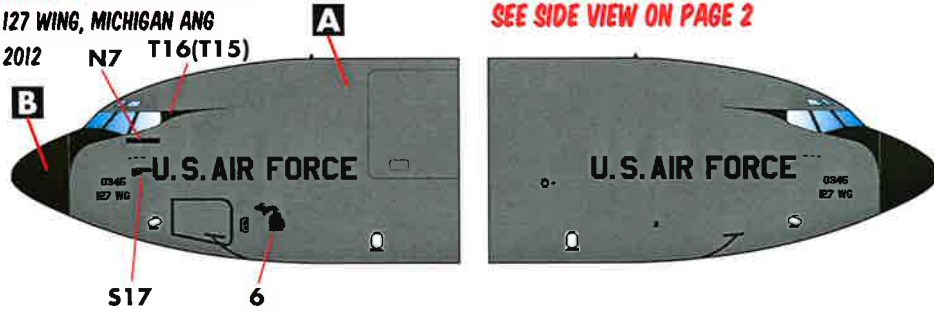

S17 6

0345
127 WG



T MICH ANG
B 127 ANG

FRONT

OPTION 12: KC-135R 59-1506

185 ARW, IOWA ANG
2013

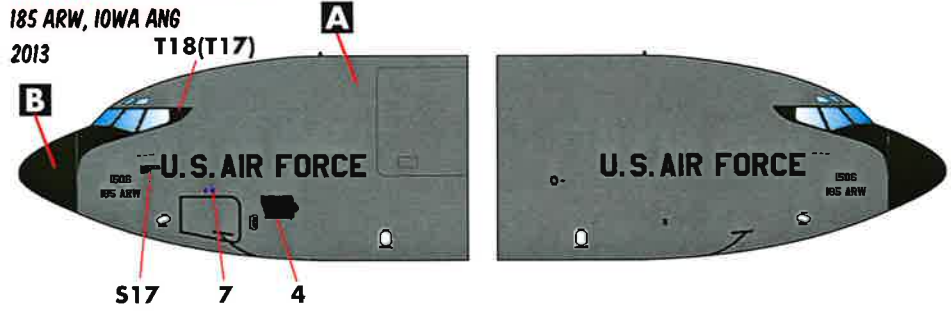

S17 7 4

1506
185 ARW



R20 R21
T 185ARW IA ANG
B 185ARW IA ANG

FRONT

OPTION 13: KC-135R 59-1500

126 ARW, ILLINOIS ANG

2011

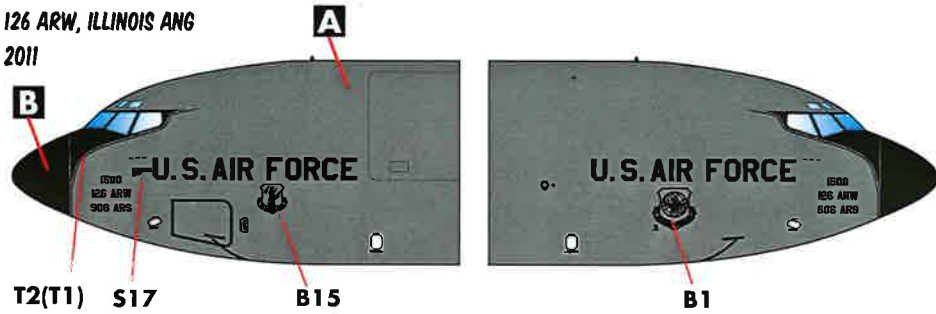

T2(T1) S17 B15

1500
126 ARW
906 ARS

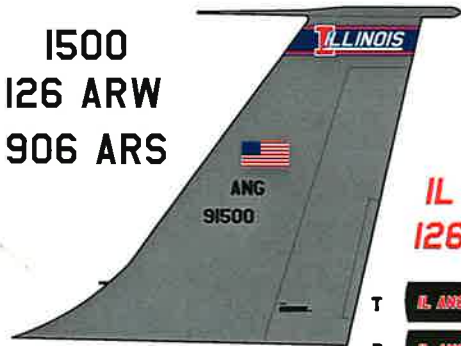

**IL ANG
126 ARW**



FRONT

1500
126 ARW
906 ARS



ANG
91500

OPTION 15: KC-135R 62-3512

128 ARW, WISCONSIN ANG

2013

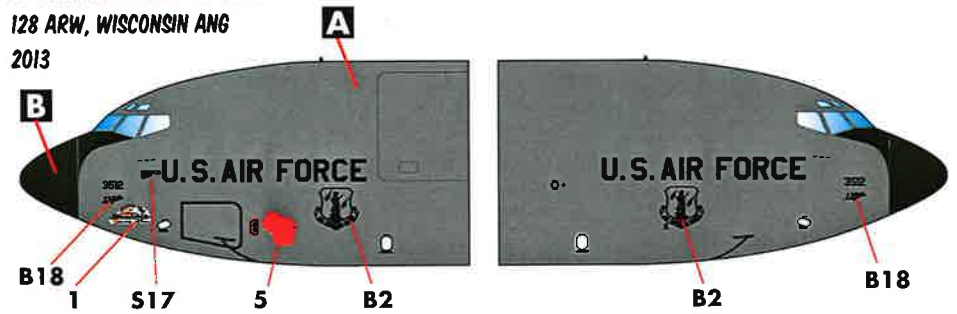

B18 1 S17 5 B2

3512
128th



FRONT

3512
128th



ANG
23512

OPTION 14: KC-135R 60-0348

18TH WING, KADENA AFB

2014

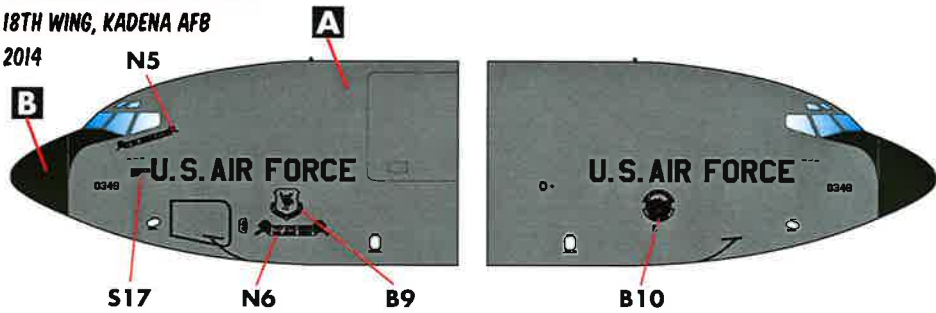

S17 N6 B9

0348

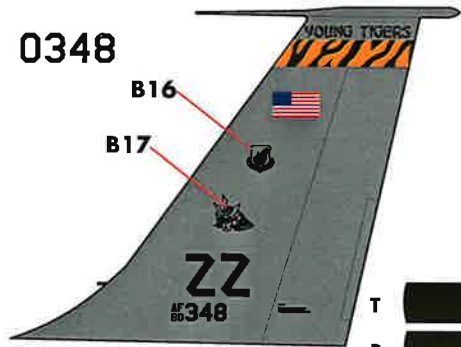

FRONT **NO RUDDERVATOR MARKINGS ON THIS AIRCRAFT**

0348

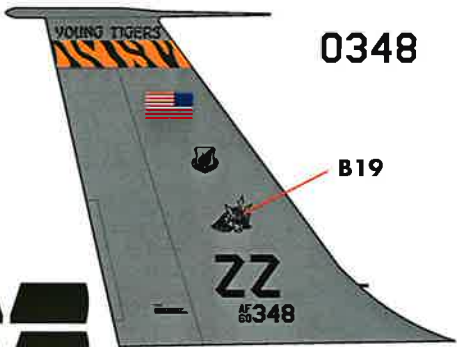

22
0348

OPTION 16: KC-135R 62-3514

108 ARW, NEW JERSEY ANG

2013

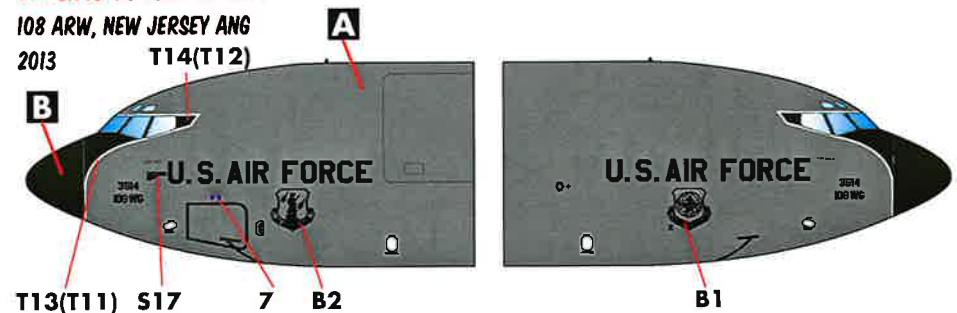

T13(T11) S17 7 B2

3514
108 WG



FRONT

3514
108 WG



ANG
23514

**TYPICAL STENCILLING
(COMMON TO ALL OPTIONS)**

NOSE AREA

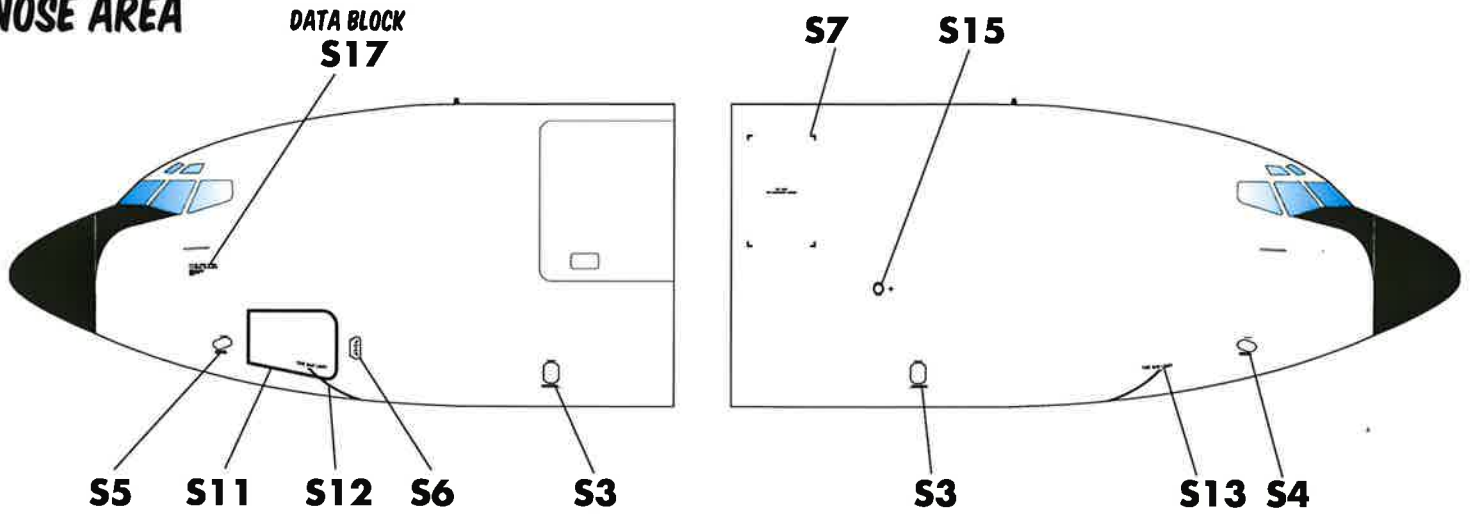

FUSELAGE MARKINGS & DOORS

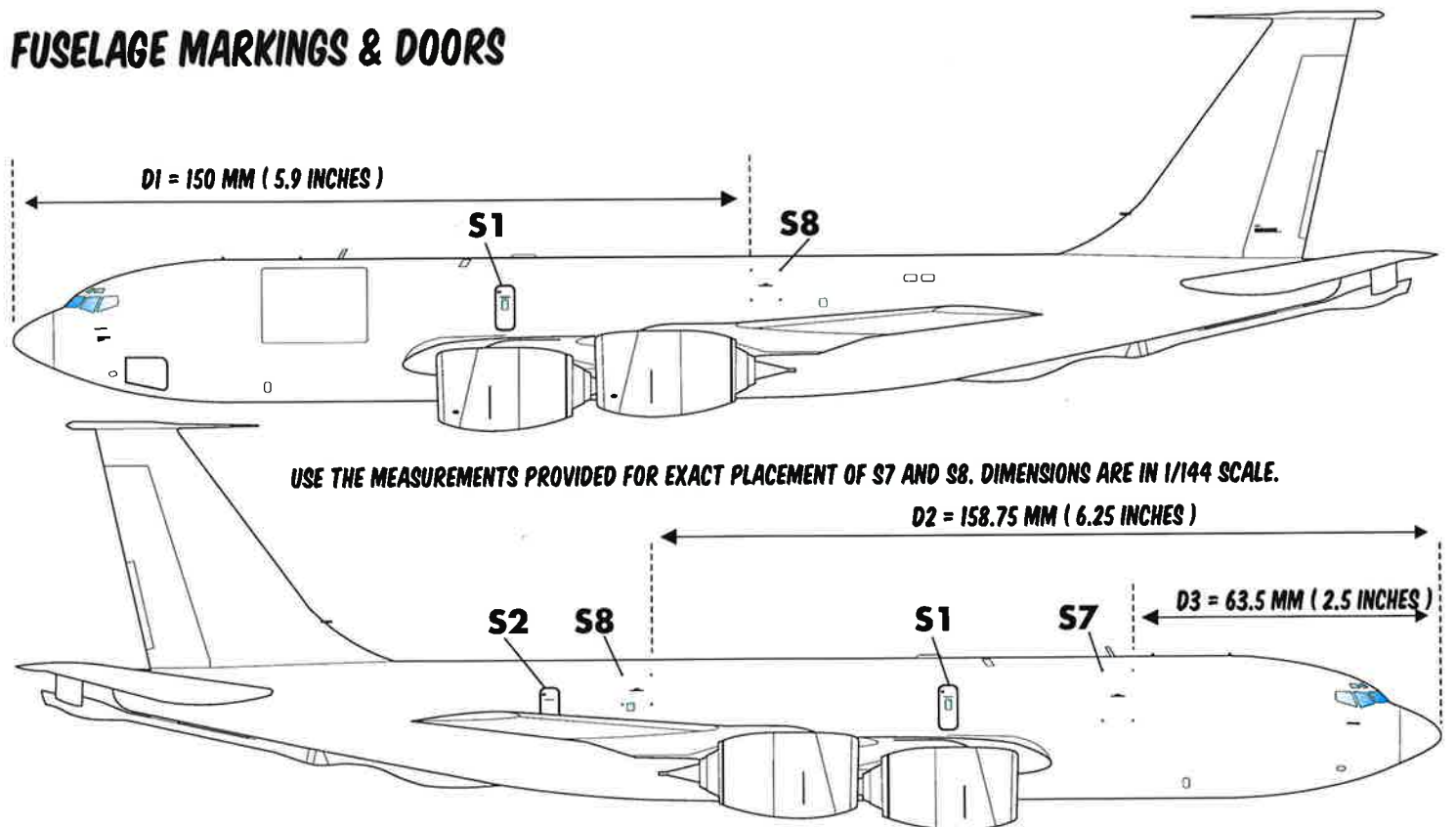

TAIL AREA

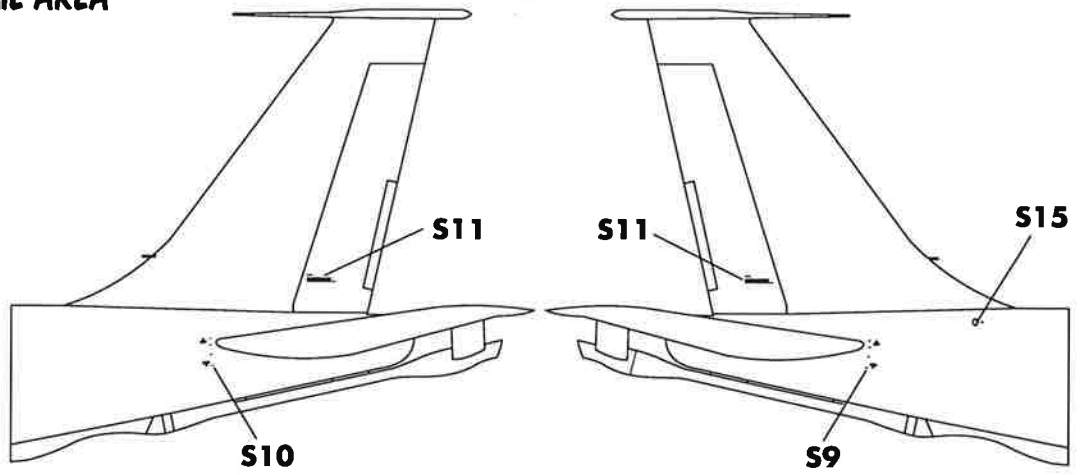

ENGINE NACELLES

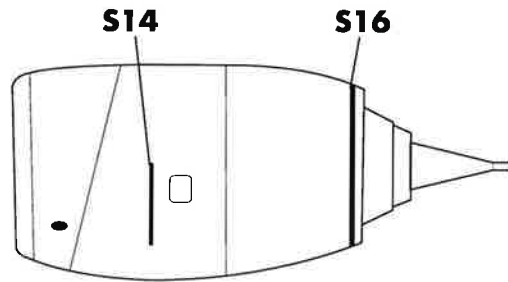

APPLY S14 ON BOTH SIDES

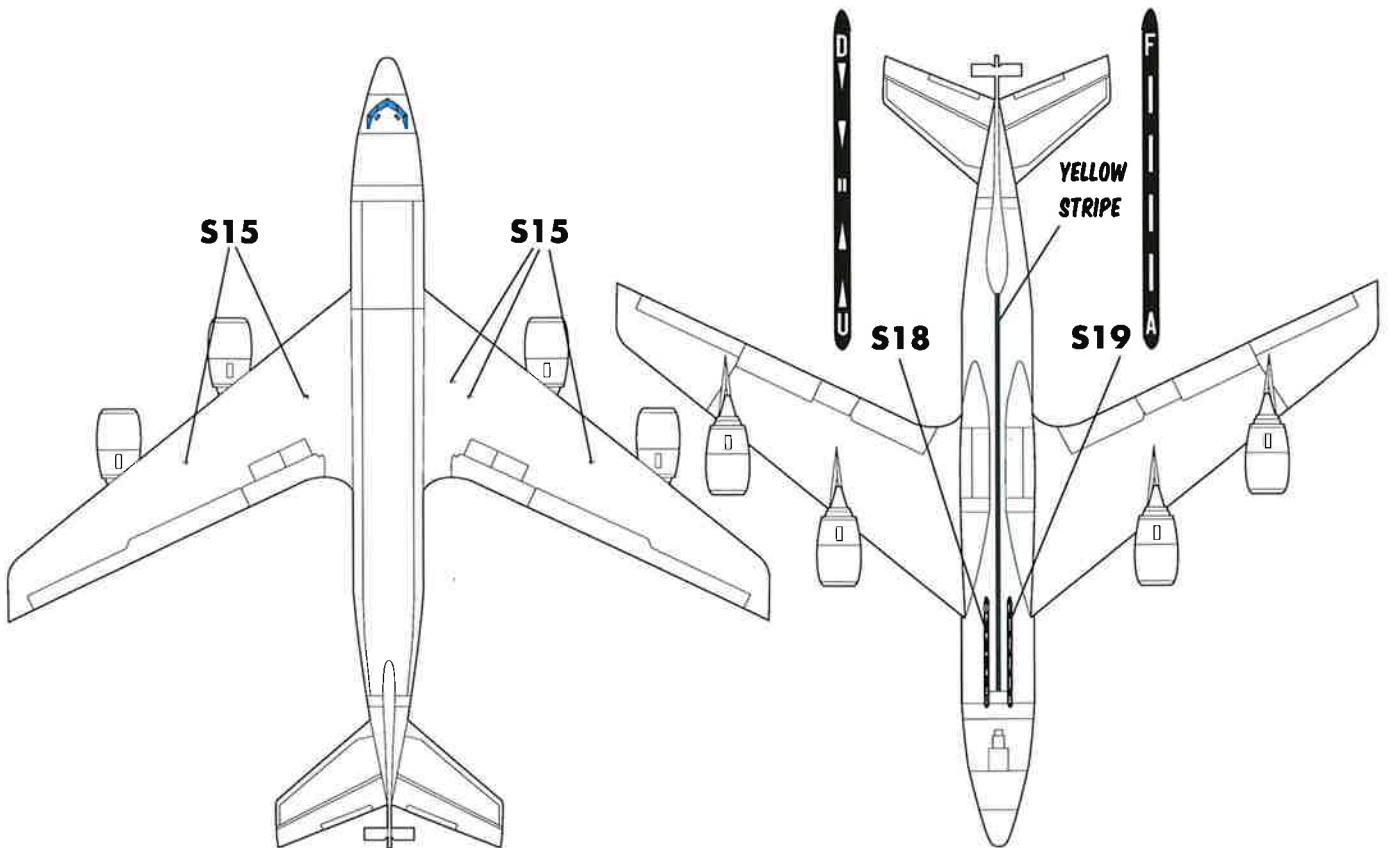

WING WALKWAYS HAVE NOT BEEN PAINTED ON USAF (AS WELL AS SINGAPORE AND TURKISH AF) KC-135R FLEET SINCE THE EARLY 2000S. DO NOT USE WING WALKWAYS FROM KIT DECALS OR OTHER AFTERMARKET SHEETS.

COLOR LIST

A AMC GRAY (FS36173)

B FLAT BLACK (FS37038)

FOR DETAIL PHOTOS TO HELP YOU WITH YOUR BUILD, VISIT:

[HTTP://WWW.CARACALMODELS.COM/REFERENCES/CDI44001](http://www.caracalmodels.com/references/cdi44001)

Caracal Models
PO Box 92141
Austin, TX 78709
info@caracalmodels.com
<http://www.caracalmodels.com>

Decals printed by Cartograf in Italy

KC-135R STRATOTANKER

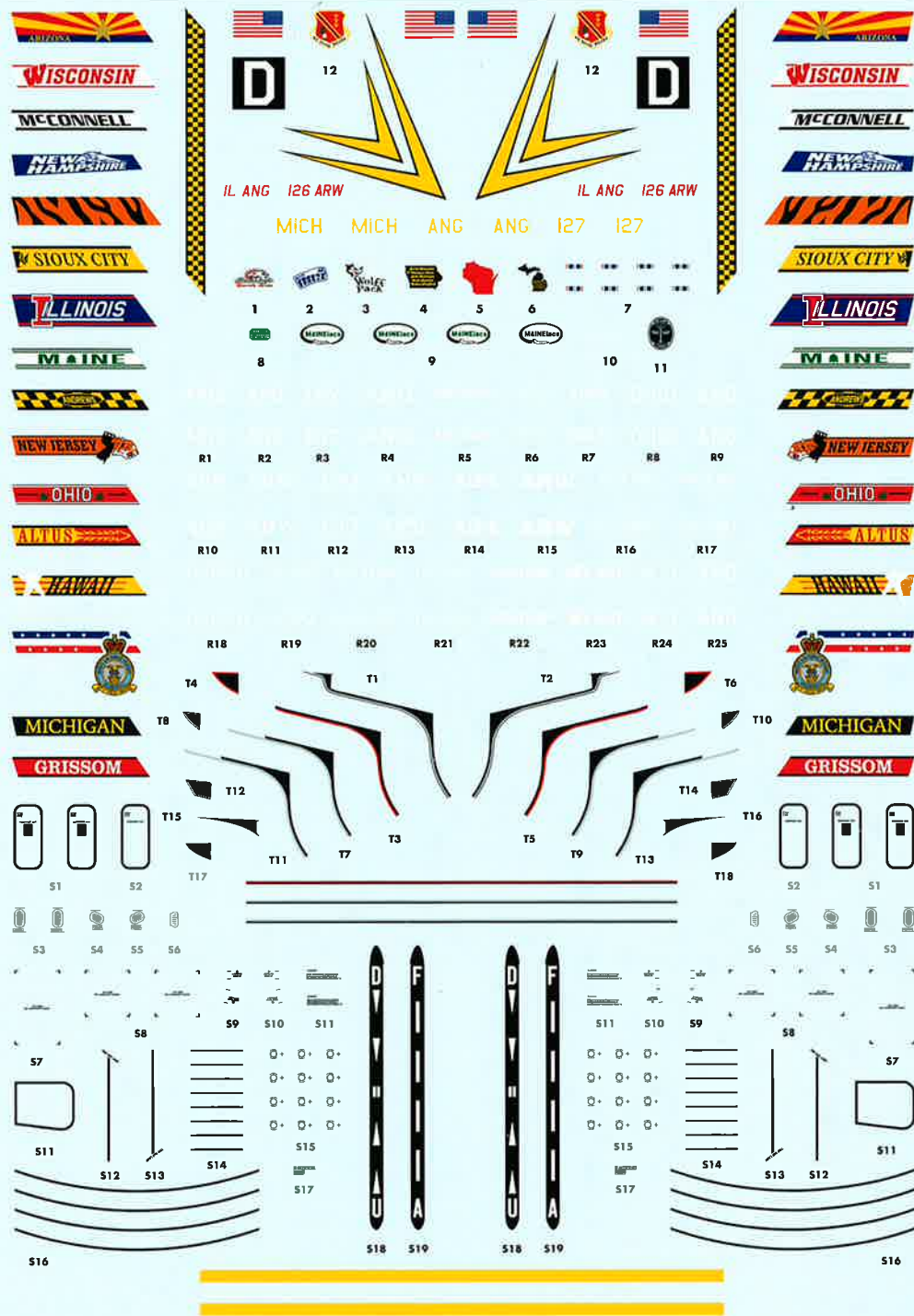

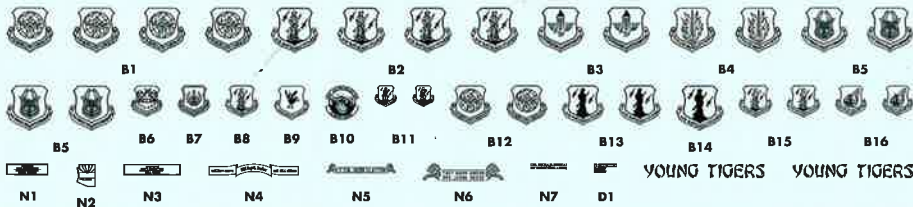

YOUNG TIGERS YOUNG TIGERS

ZZ ZZ   **AF 60 348 AF 60 348 AF 60 0318 AF 60 0318 HH HH**

23516 23576 38872 10305 14840 23543 80001 80102 80065 00345 91506
 23516 23576 38872 10305 14840 23543 80001 80102 80065 00345 91506
 91500 23512 23514 3516 3576 8872 0306 4840 3543 0001 0102 0065 0345 0318 1506 1500 0348 3512 3514
 91500 23512 23514 3516 3576 8872 0305 4840 3543 0001 0102 0065 0345 0318 1506 1500 0348 3512 3514

161 ARW 97th AMW 121 ARW 459 ARW 434 ARW 127 WG 185 ARW 108 WG 157 ARW 100 ARW 22 ARW 22 ARW 154th WG 154th WG 126 ARW 126 ARW
 161 ARW 97th AMW 121 ARW 459 ARW 434 ARW 127 WG 185 ARW 108 WG 157 ARW 100 ARW 22 ARW 22 ARW 154th WG 154th WG 126 ARW 126 ARW

USAF U.S. AIR FORCE U.S. AIR FORCE **USAF**
USAF U.S. AIR FORCE U.S. AIR FORCE **USAF**
USAF ANG ANG AMC AMC AETC AFRC USAF **USAF**
USAF ANG ANG AMC AMC AETC AFRC USAF **USAF**

