

eduard
MASK

P2V-7 Neptune 1/72

The die-cut mask for accurate canopy frame painting of the
Hasegawa scale 1/72 KIT

CX 137

2 pcs.
34

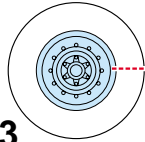
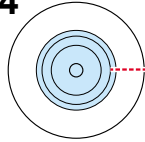

2 pcs.
33

2 pcs.

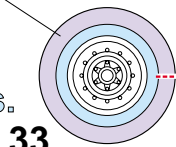
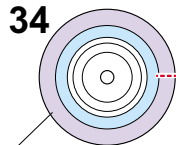

2 pcs.
33

LIQUID MASK

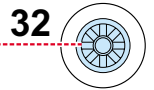
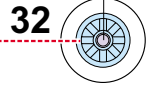

LIQUID MASK

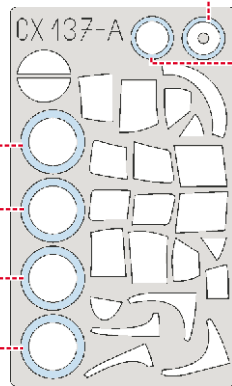
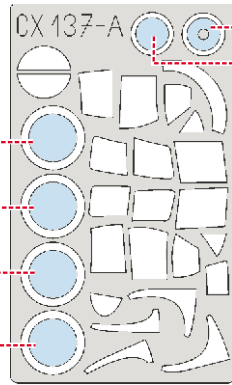
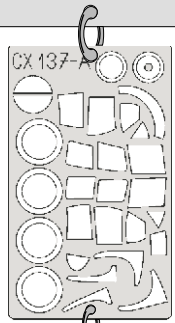
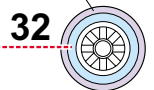
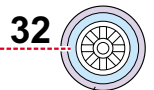

A-A

1.)
87

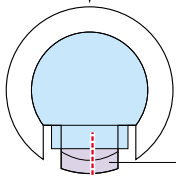

LIQUID MASK

3.)
87

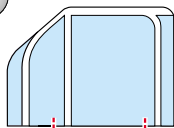

5.)

INTERIOR COLOR

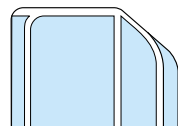
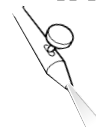

6.)

CAMOUFLAGE COLOR

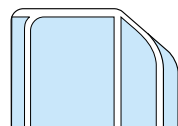

2.)
87

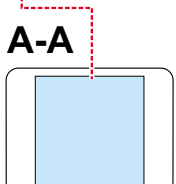

4.)
87

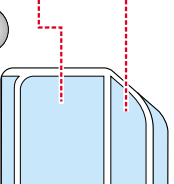

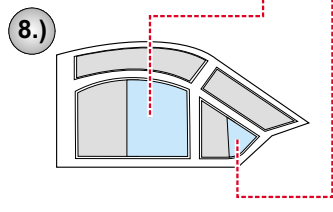
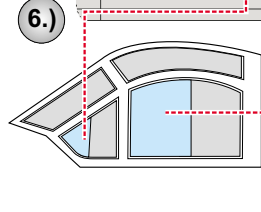
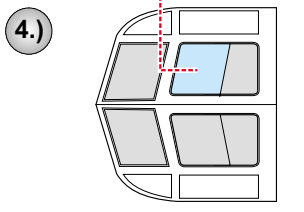
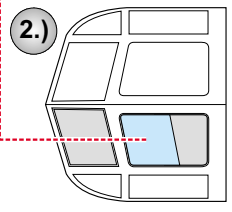
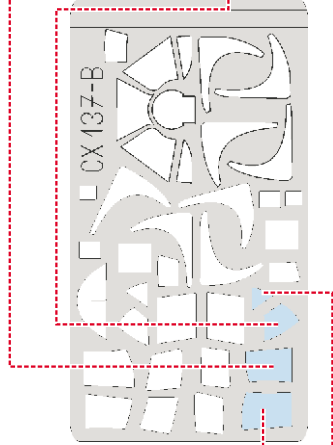
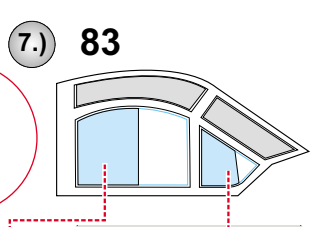
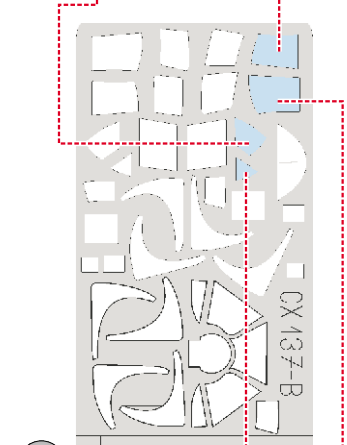
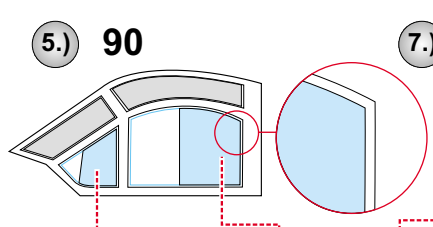
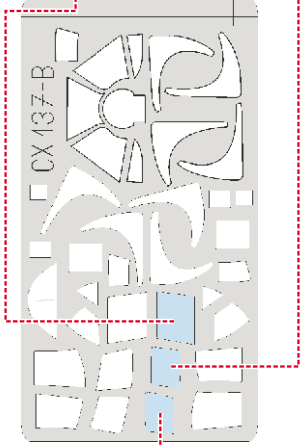
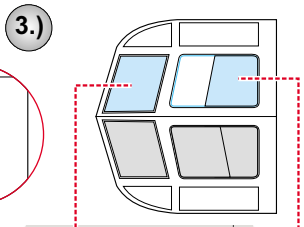
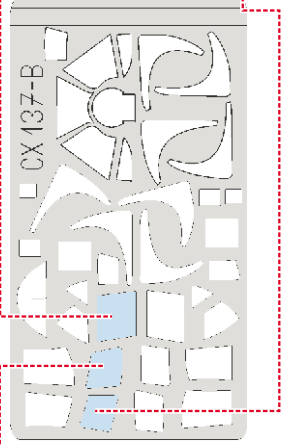
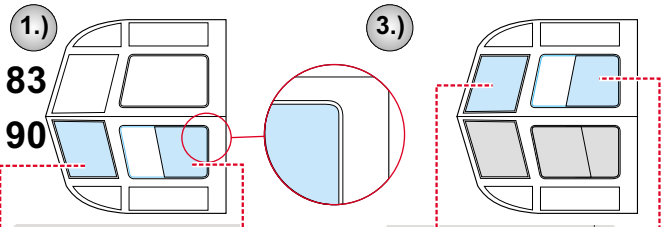

9.) **INTERIOR COLOR**

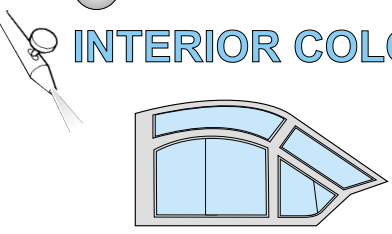

10.) **RUBBER COLOR**

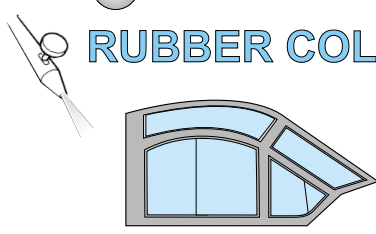

11.) **REMOVE MASK**

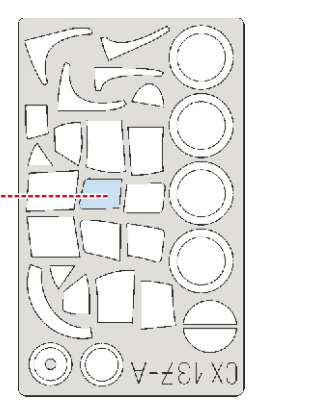
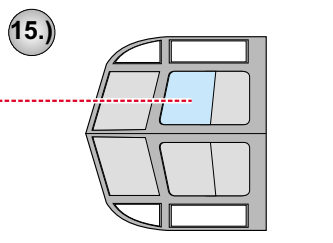
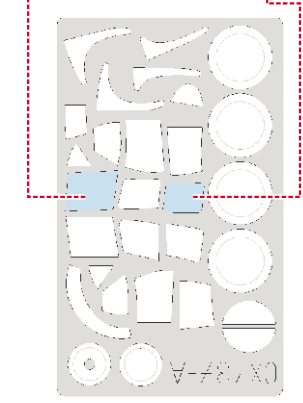
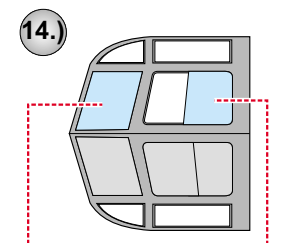
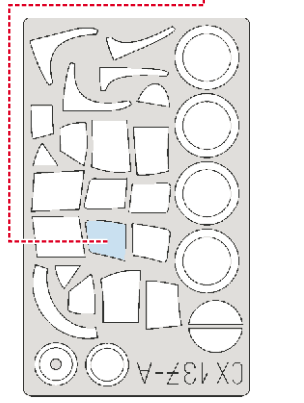
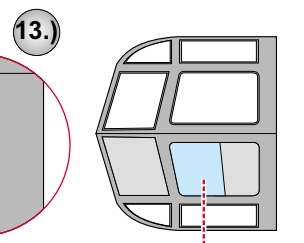
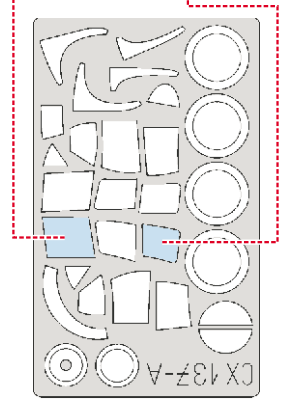
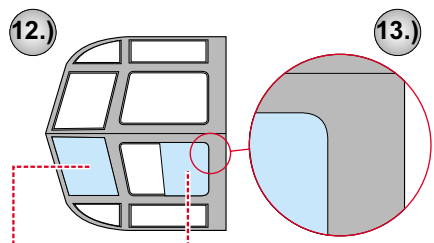
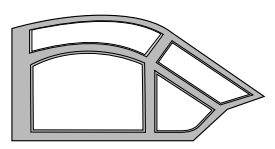

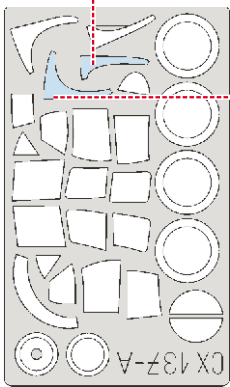
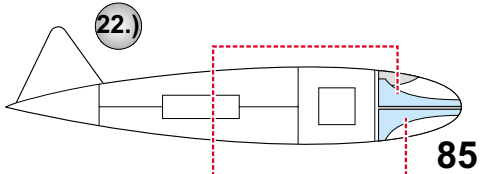
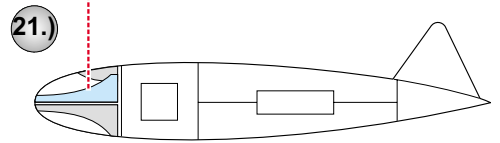
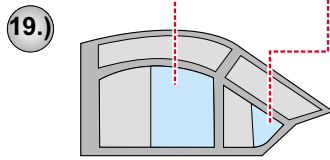
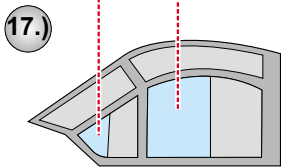
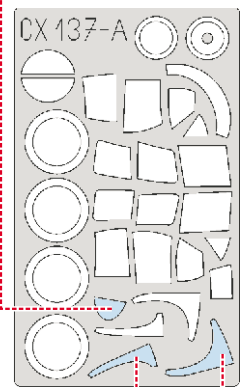
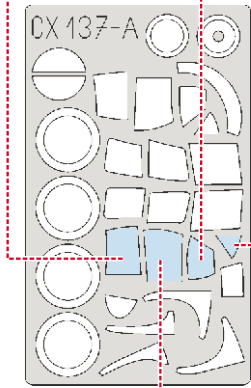
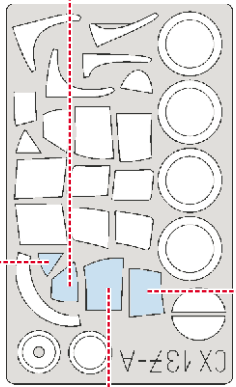
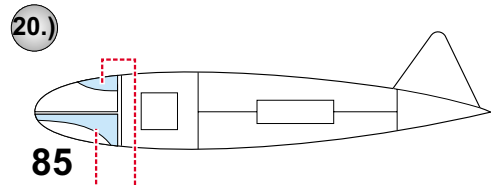
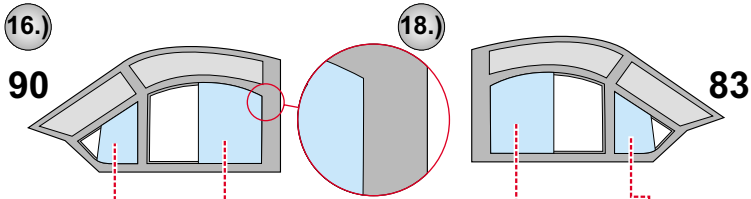

CAMOUFLAGE COLOR

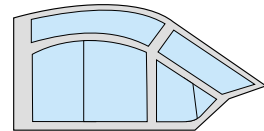

■ - LIQUID MASK

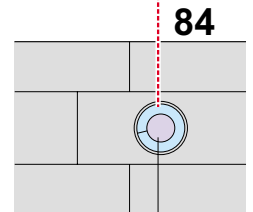
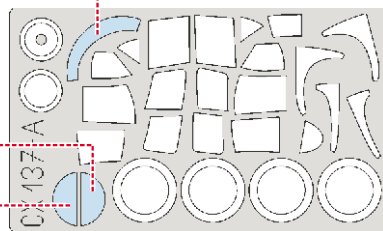
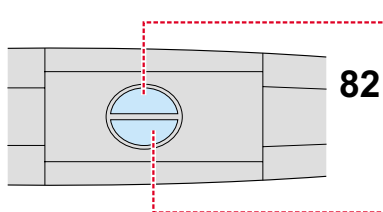
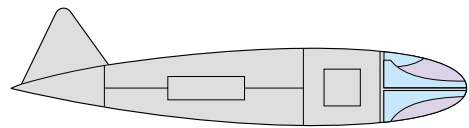

LIQUID MASK

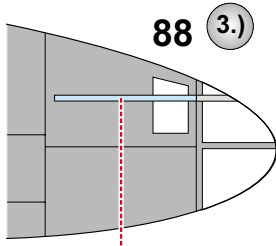
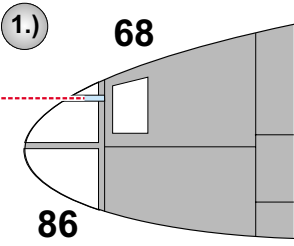

4.) **INTIREFLEX BLUE COLOR**

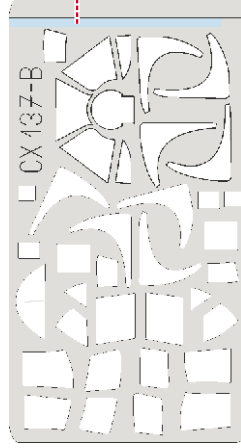
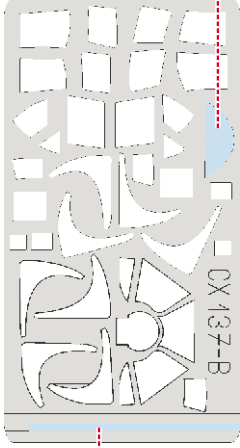
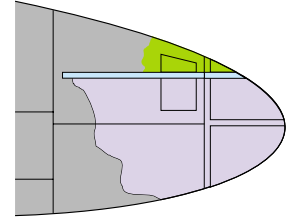

5.) **REMOVE MASK**

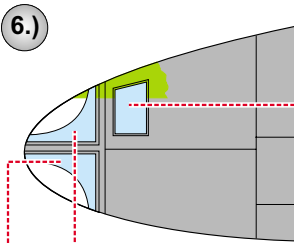
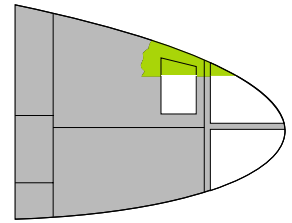
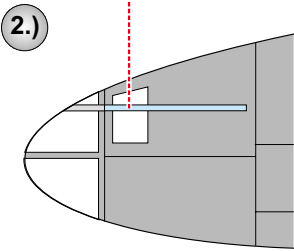

8.) **INTERIOR COLOR**

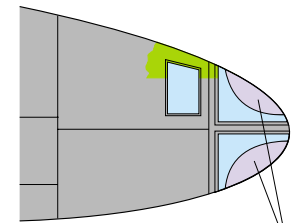

LIQUID MASK

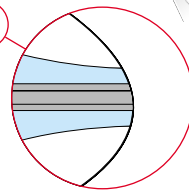
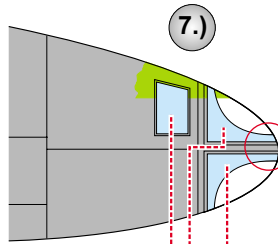

9.) **RUBBER COLOR**

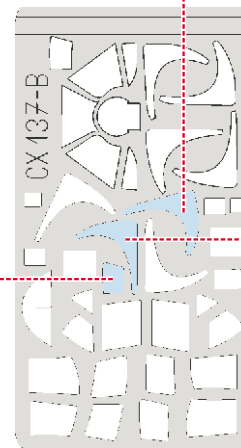
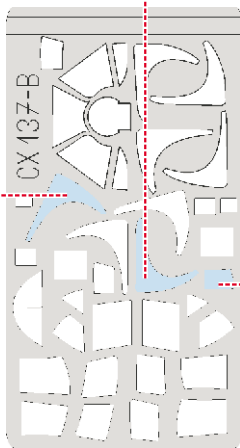
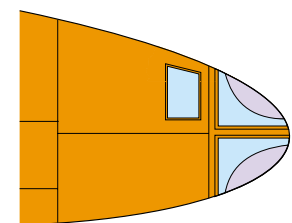

10.)

REMOVE MASK

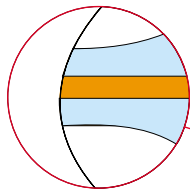
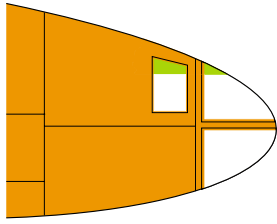

11.)

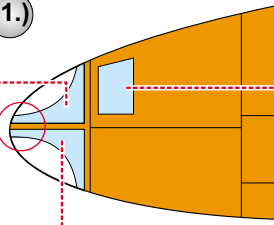

12.)

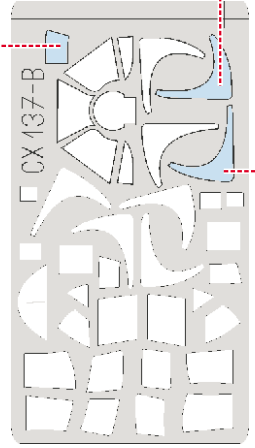
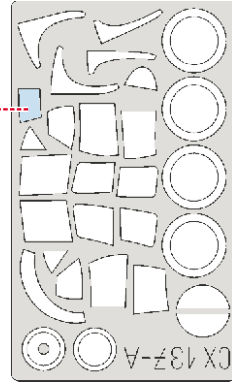
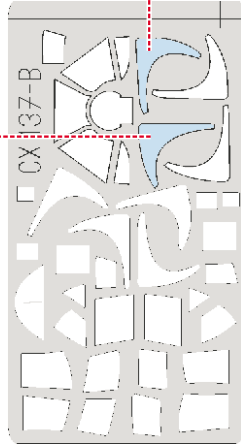
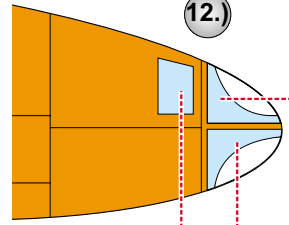

13.)

CAMOUFLAGE COLOR

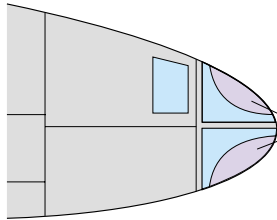

LIQUID MASK

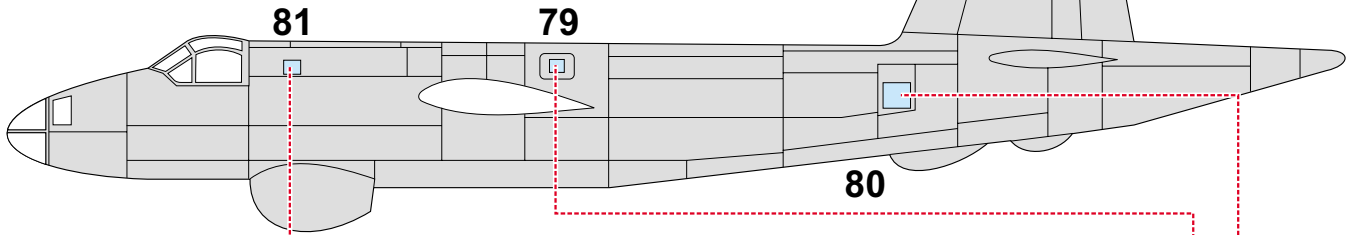

81

79

80

REFERENCES: Squadron/Signal Publ.:In Action # 1068 - P2V Neptune
Air Fan # 5
FAOW # 50
Replic # 80
RT # 13/6

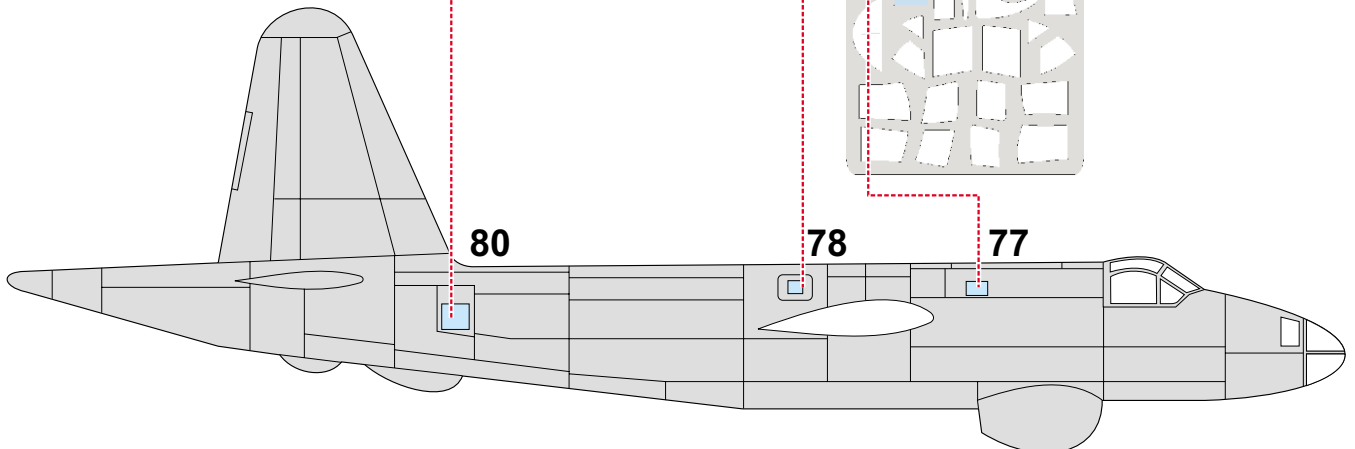
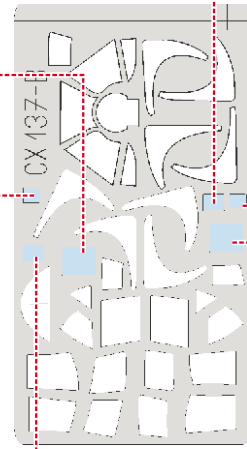

80

78

77