

eduard
Express Mask

XS 107

P2V-7 Neptune

Hasegawa 1/72 KIT

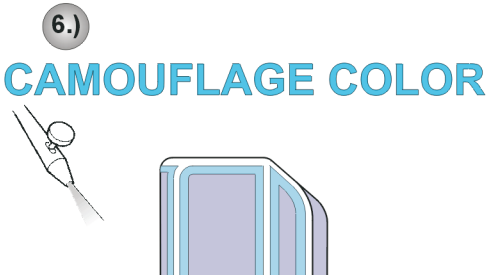
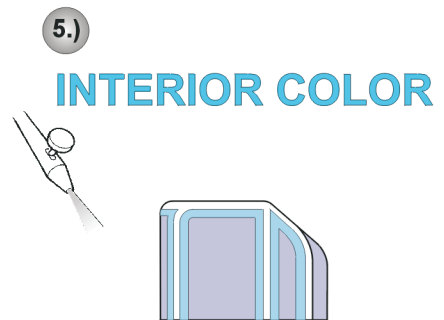
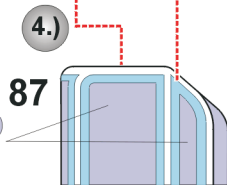
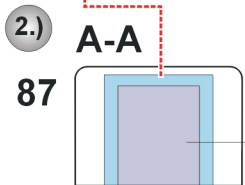
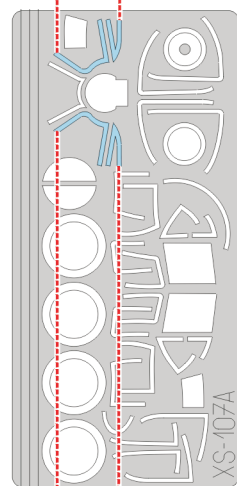
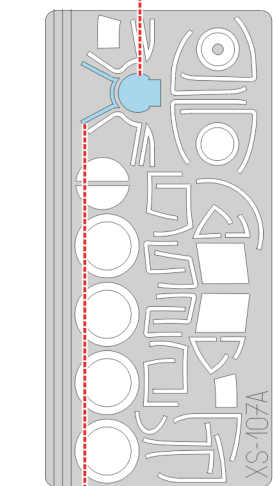
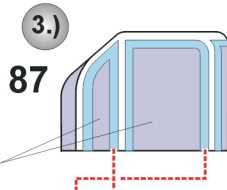
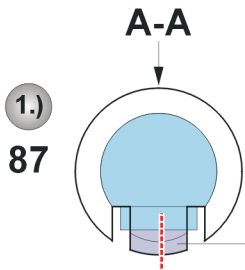
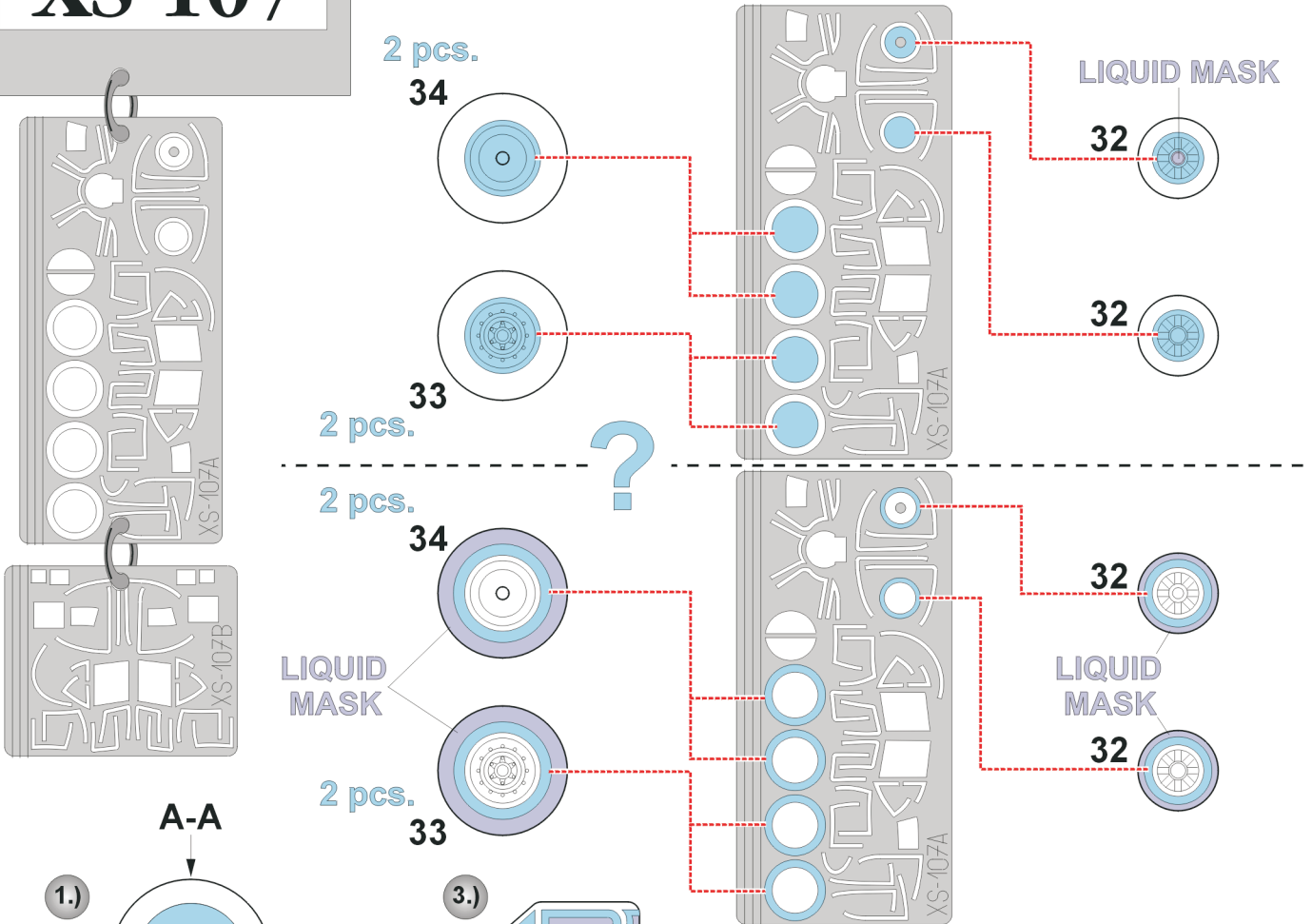

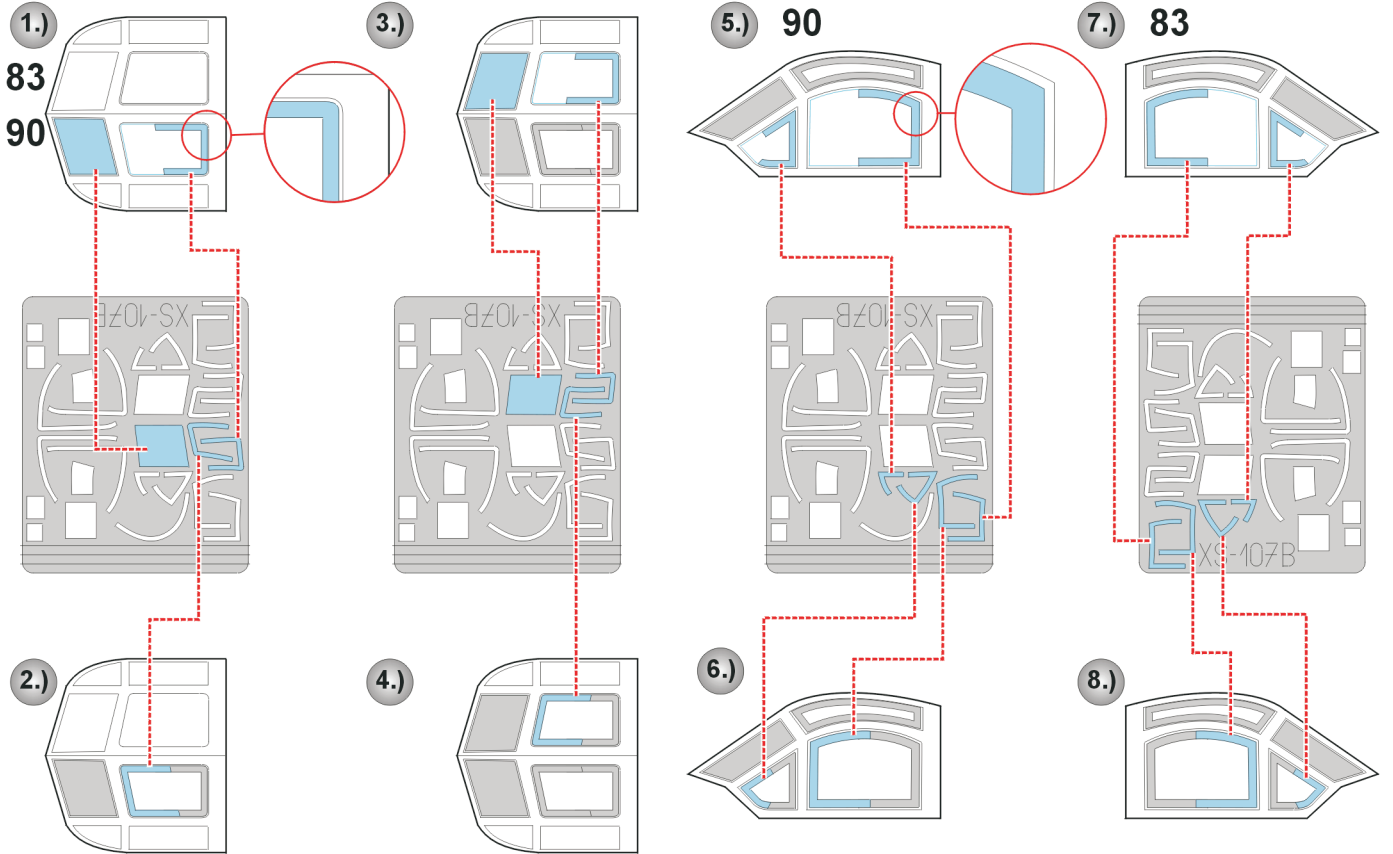

■ - LIQUID MASK

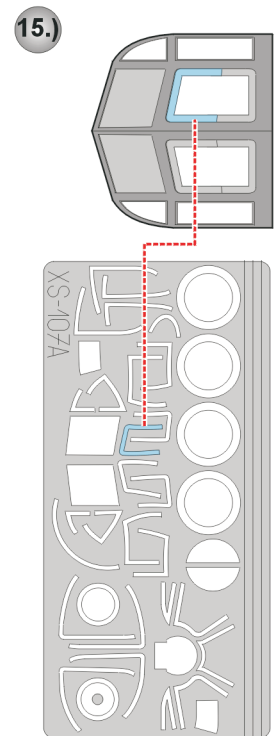
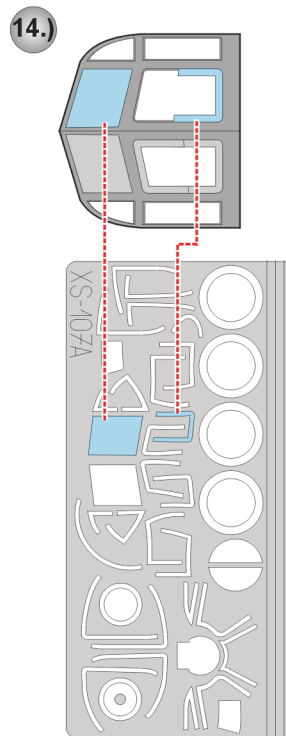
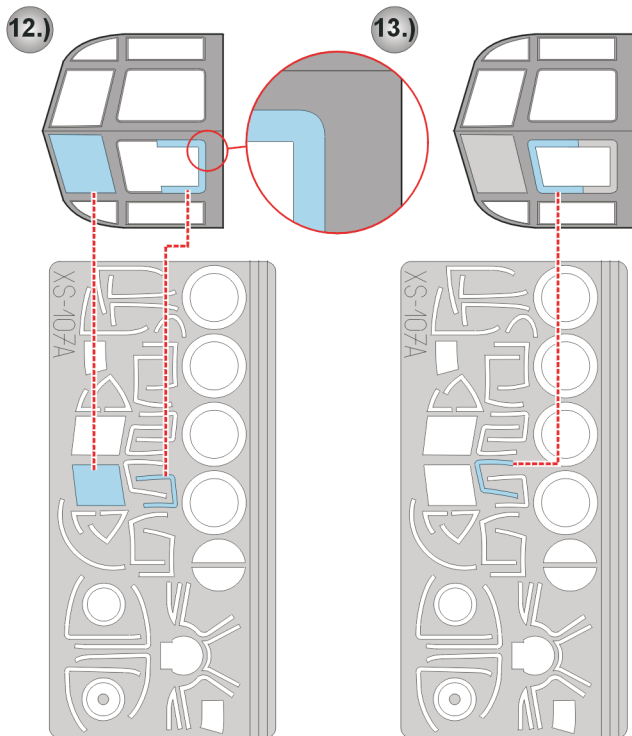
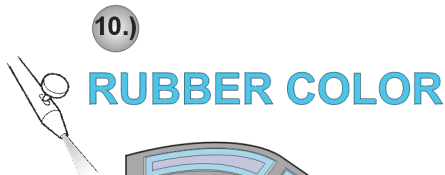

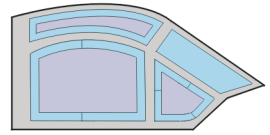
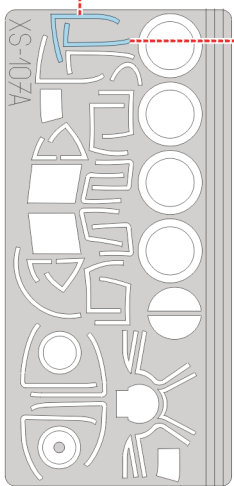
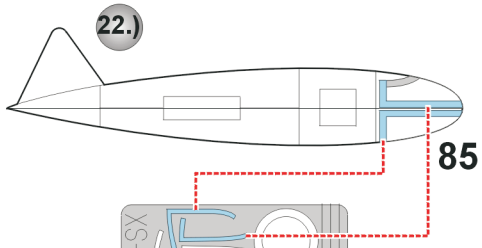
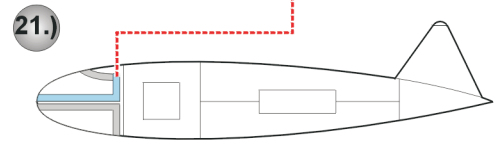
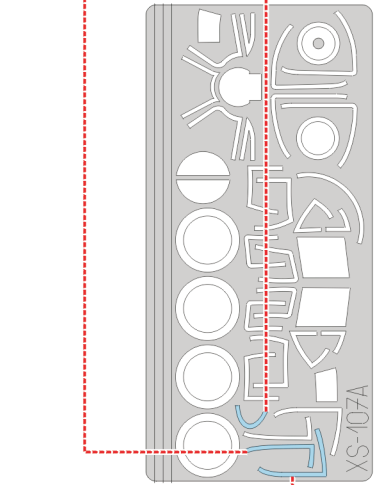
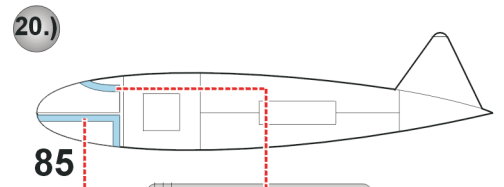
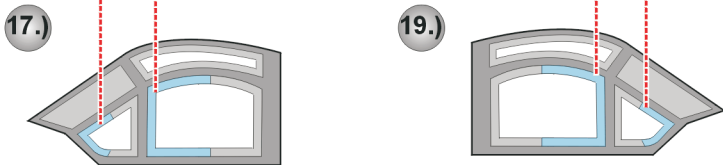
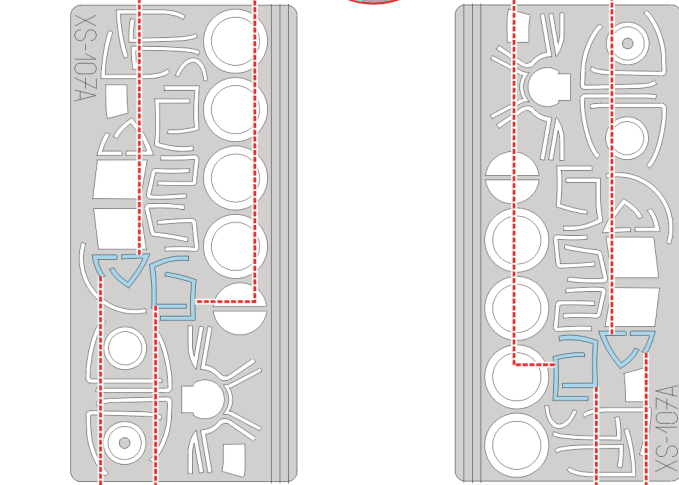
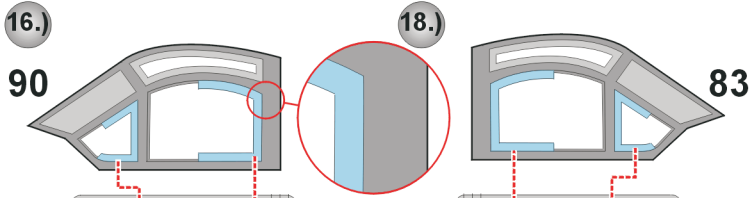

— LIQUID MASK

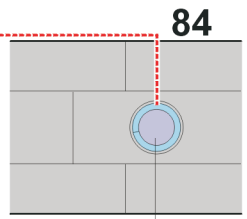
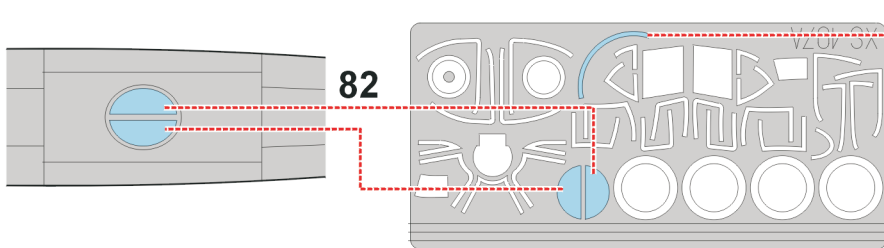
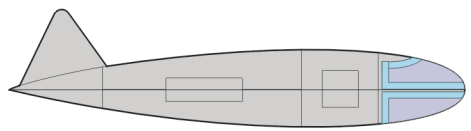

LIQUID MASK

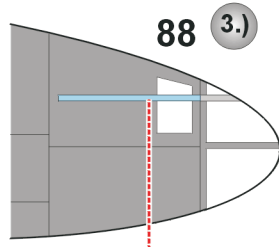
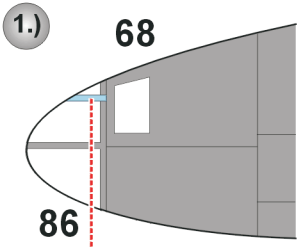

4.) **INTIREFLEX BLUE COLOR**

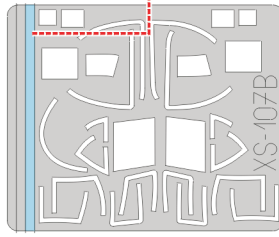
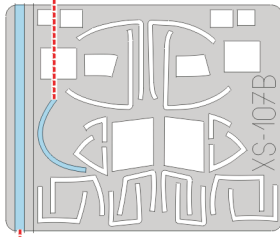
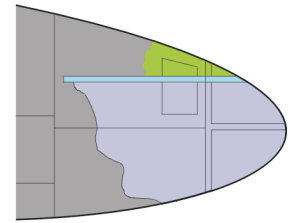

5.) **REMOVE MASK**

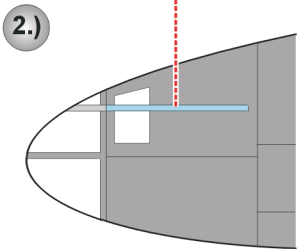
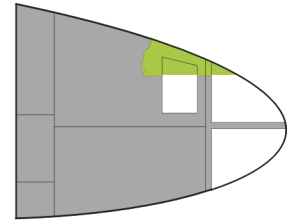

8.) **INTERIOR COLOR**

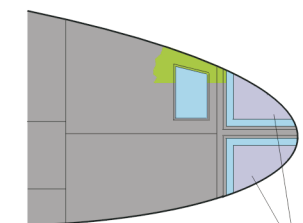

LIQUID MASK

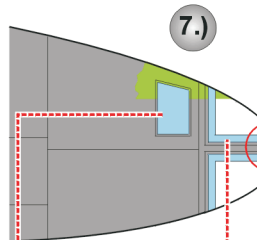
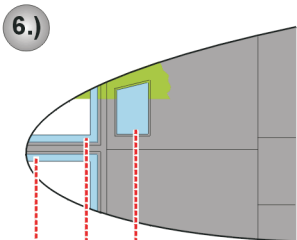

9.) **RUBBER COLOR**

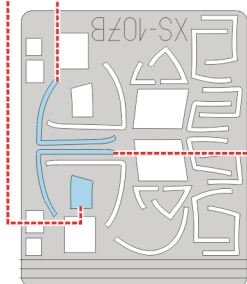
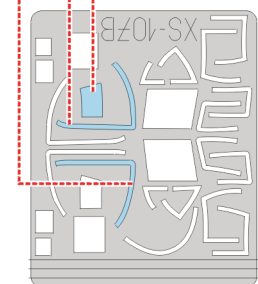
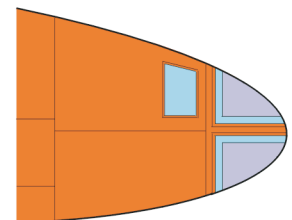

10.)

REMOVE MASK

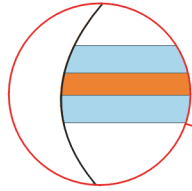
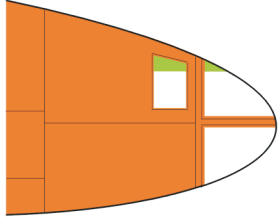

11.)

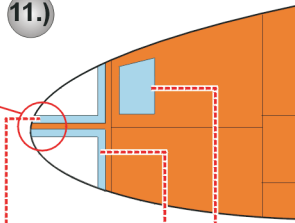

12.)

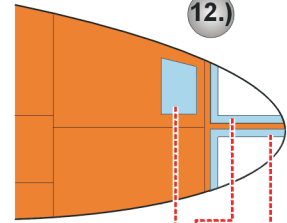

13.)

CAMOUFLAGE COLOR

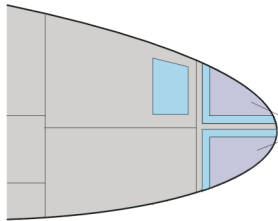
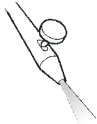

LIQUID MASK

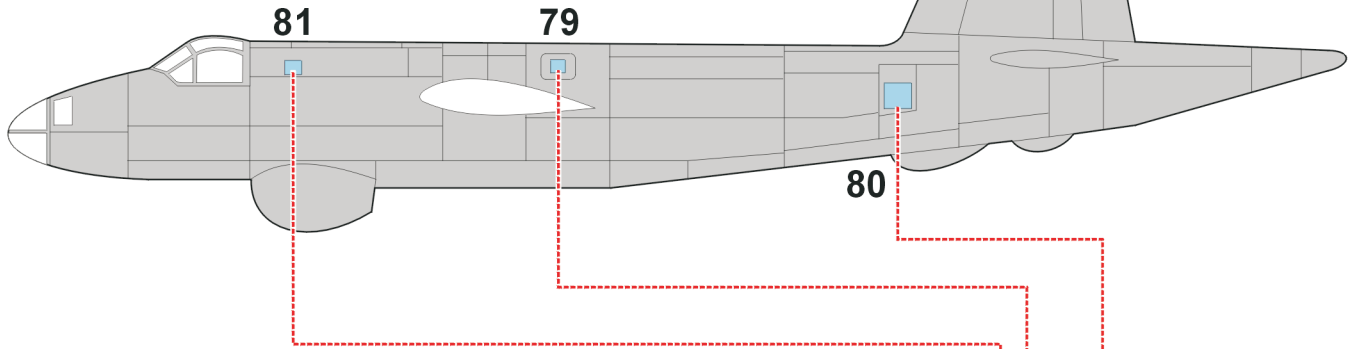
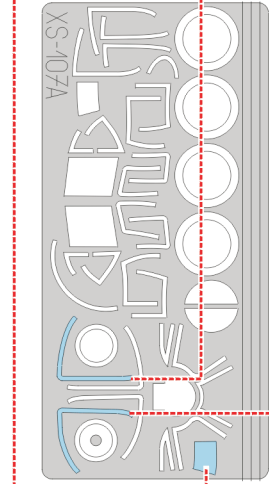
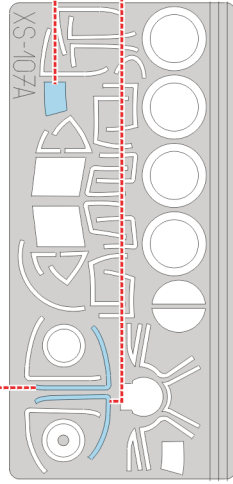

REFERENCES: Squadron/Signal Publ.: In Action # 1068 - P2V Neptune
Air Fan # 5
FAOW # 50
Replic # 80
RT # 13/6

