

CUT

USE A SAW TO REMOVE SUPPORTS FROM 3D PRINTED PARTS

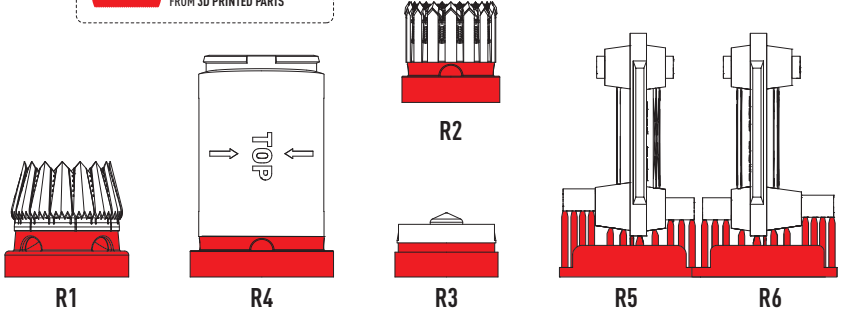

1

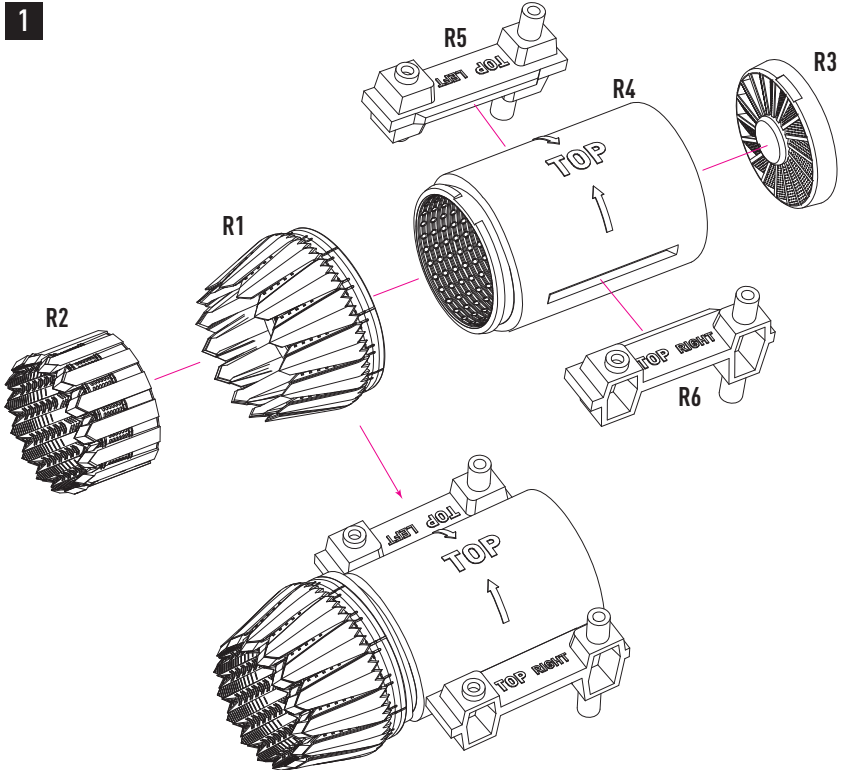

2

