

1/35 MILITARY MINIATURE VEHICLE UPGRADE SERIES PEA421









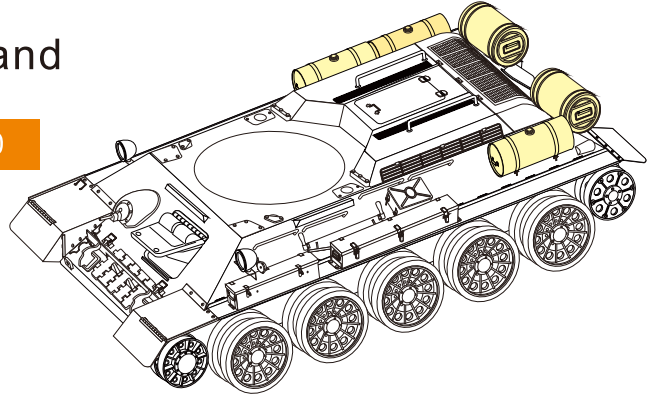
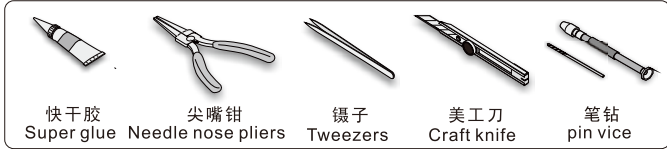

# WWII Soviet tank exterior tanks and smoke generators 2.0

## 二战苏军坦克用圆桶状副油箱以及发烟罐2.0

[GP]

■ 推荐使用工具 RECOMMENDED TOOLS



-   
 安装  
install
-   
 折叠  
bend
- A1**  
 改造件零件编号  
PE/resin part number
- B12**  
 原零件编号  
kit part number
- C22**  
 被替换的原零件编号  
replaced kit part number
-   
 另一侧相同制作  
repeat on opposite side
-   
 切除  
remove
-   
 打磨  
grind off
-   
 弧度卷曲  
radial bending
-   
 制作若干组  
multiple assembly
-   
 选择安装  
alternative
-   
 钻孔  
drill
-   
 用胶棒制作  
make from plastic rod

  
 用尖端在凹槽处冲压  
use penpoint to press on the dent

蚀刻片零件内朝面向上  
Put the part upside down  
 用笔尖在凹槽处刺  
Use penpoint to press on the dent

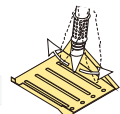

[Http://www.voyagermodel.com/productdetails.asp?itemid=PEA421](http://www.voyagermodel.com/productdetails.asp?itemid=PEA421)



**VOYAGER MODEL**

更多PEA 421样品照片参考请扫一扫  
MORE PICTUER OF PEA421  
REFERENCE SCAN HERE

