

# TRAM of Br52

	切除阴影部分 Cut away		钻孔 Make a hole	00	蚀刻片零件标号 Number of PE parts		注解一 Note 1		注解3 Note 3
	锉平阴影部分 Rasp away		另一侧相同制作 Repeat opposite side	00	原套件零件标号 Number of original parts		根据喜好选择安装 Optional		注解4 Note 4
	填补 Use filler		安装箭头 Install arrow	00	被替换的套件标号 Number of replaced parts		制作所示若干组 Make some pcs		
	弧度弯折 Bend		弯折箭头 Fold arrow		使用圆棒制作 Use ABS rod		注解一 Note 1		

PE UPDATE  
For Trumpeter 00210

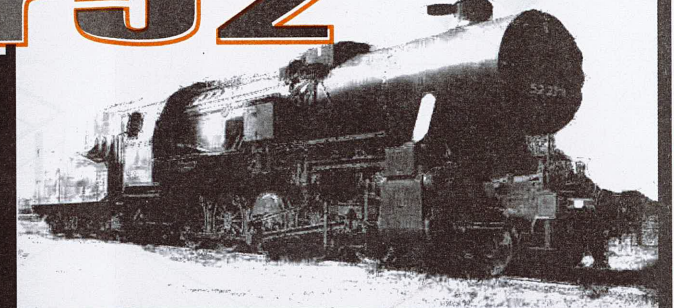

1/35 MILITARY MINIATURE VEHICLE PE UPGRADE SERIES NO.101

RECOMMENDED TOOLS  
推荐使用工具



美工刀  
Modeling knife

笔钻  
Pin vise

镊子  
Tweezers

尖嘴钳  
Needle-nose pliers

快干胶  
Super glue

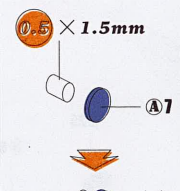
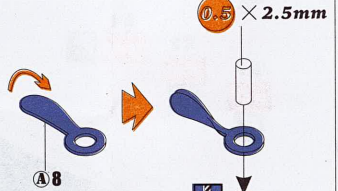
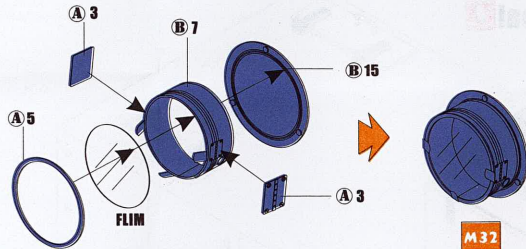

A

B

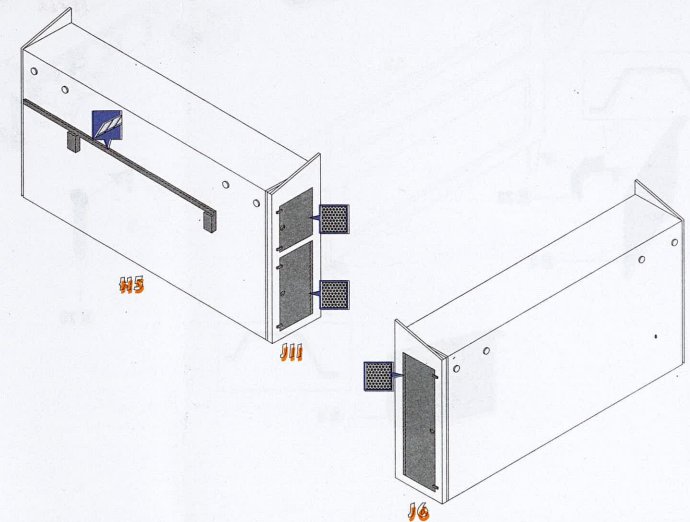
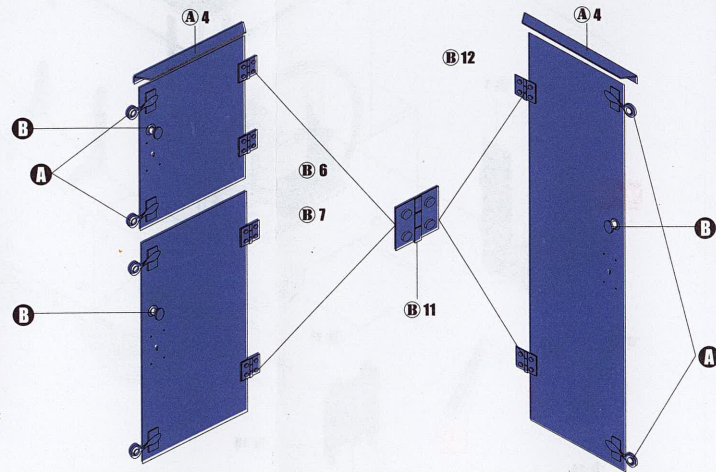
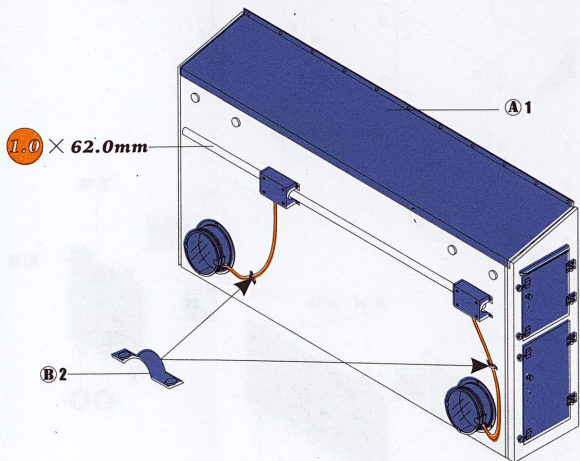

**VOYAGERMODEL**<sup>®</sup> PE UPGRADE SET FOR BR 52  
The Best Upgrade Solution

PE 35097 TRU Steifrahmentender smoke drive sprocket wheels of Br52

PE 35098 TRU Baureihe 52 basic kit part 1

PE 35099 TRU Baureihe 52 basic kit part 2

PE 35100 TRU Baureihe 52 exterior

PE 35101 TRU Tram for BR 52 /w coal

