

Bell 412 N302FD interior details set

Parts of the kit are made from photopolymer resin, sensitive to UV light.

Parts should avoid of sunlight, until primed or painted.

Detaching parts from a supports is recommended with sharp blade, file, nippers or mill/grinder.

For thicker supports, use saw or drill/grinder.

Use cyanoacrylate glue.

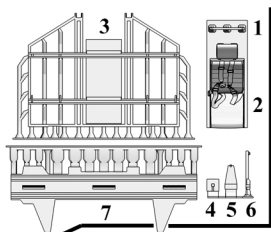

remove supports marked as RED on schemes

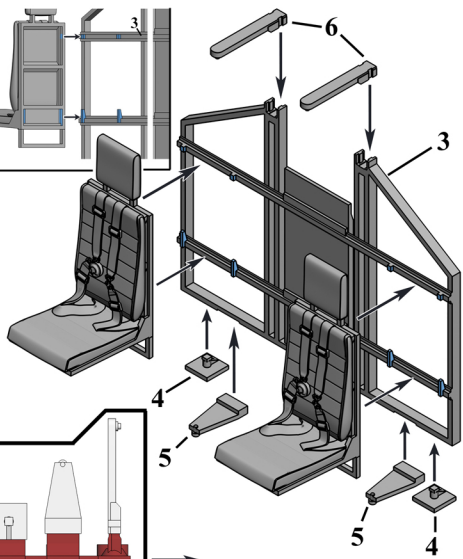
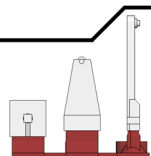
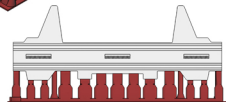
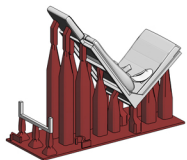
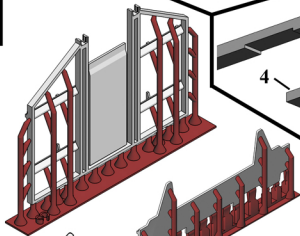
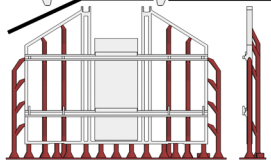
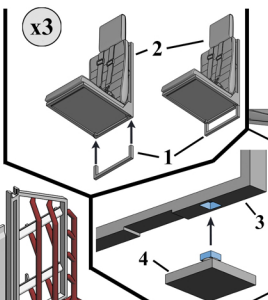

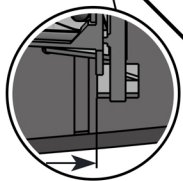
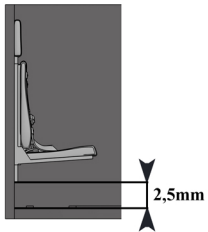
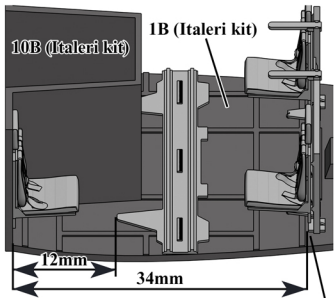

- A** Black matte
- B** Chrome
- C** Flat Aluminium
- D** Medium warm Gray

