

eduard
Express Mask

XS 205

Mi-24D Hind

The die-cut mask for accurate canopy frame painting of the
Hasegawa 1/72 KIT

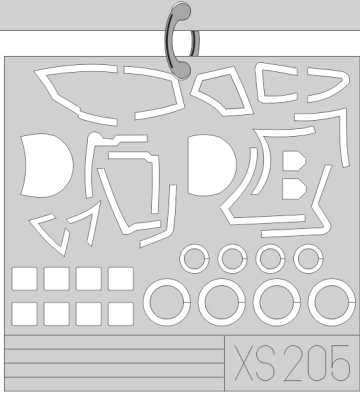

D 10
2pcs.

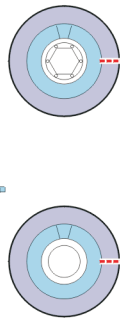

D 11
2pcs.

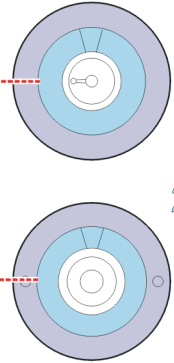

I 1
4pcs.

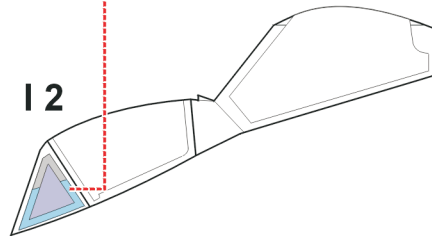
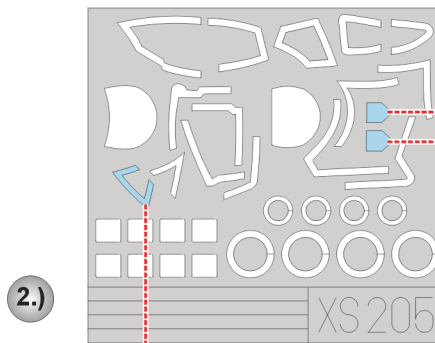
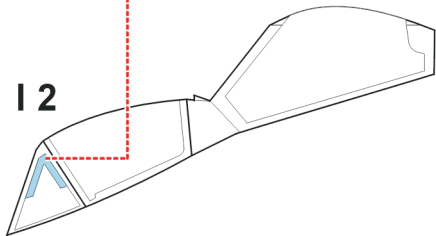
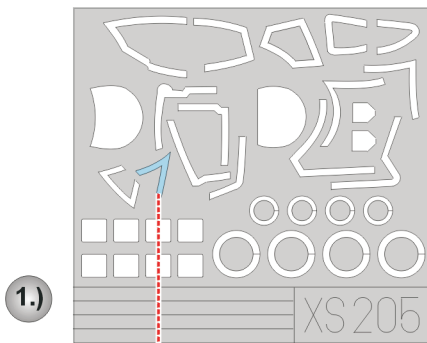
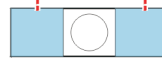

I 3

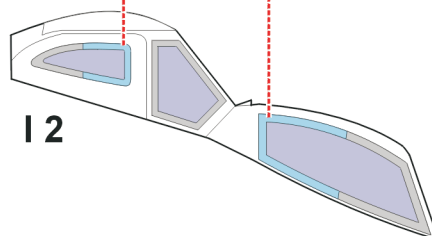
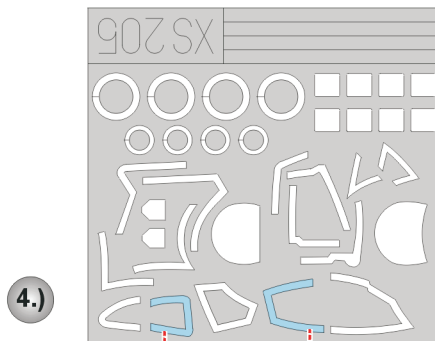
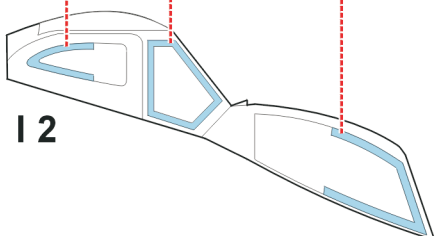
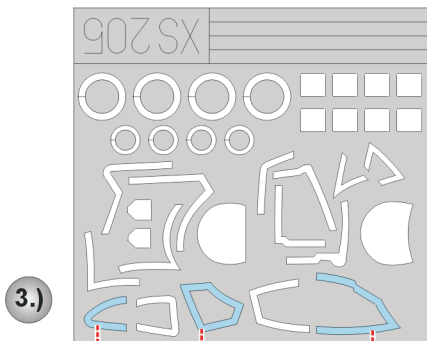

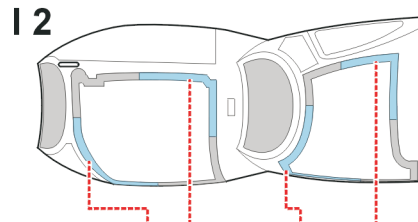
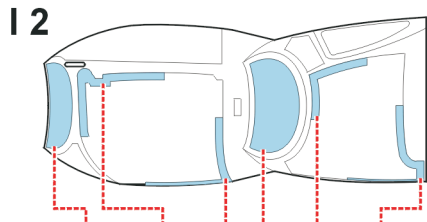

5.)

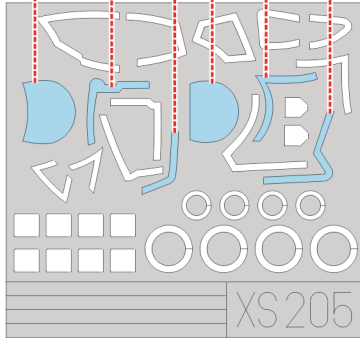

6.)

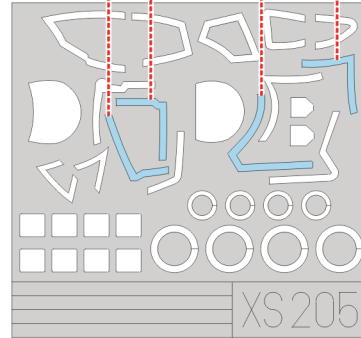

7.) INTERIOR COLOR

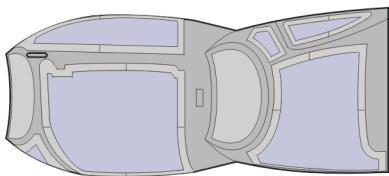
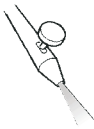

LIQUID MASK

8.) CAMOUFLAGE COLOR

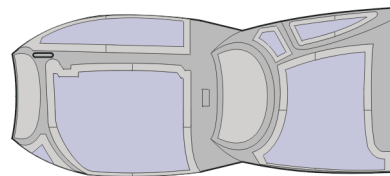
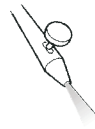

LIQUID MASK

9.) REMOVE MASK

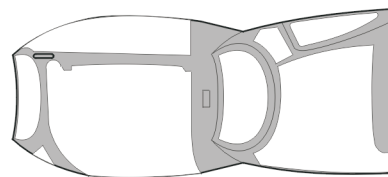

REFERENCES: Sqadron/Signal Publ. In Action - # 1083 - Mi-24 HIND
Kit flugzeug-modell journal 2/2002