

He 162 B B-1, B-2, B-3, B-4, B-5, B6

Salamander

Plastic model
scale 1/72

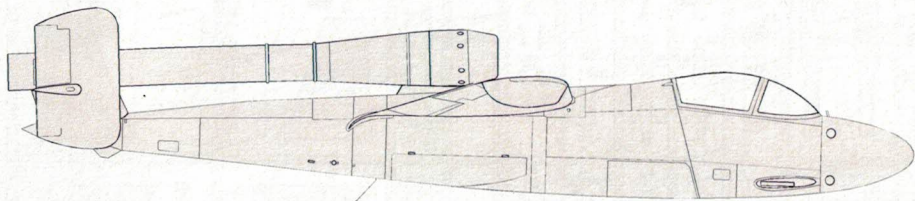

Historie

Heinkel He 162 Spatz byl německý proudový stíhací letoun, který sloužil v řadách Luftwaffe v posledních měsících druhé světové války. Letoun byl znám i pod označením Volksjäger (lidový stíhač) nebo také chybně Salamander (Mlok). Sériová výroba se rozběhla v lednu 1945 a hlavní výrobní variantou byl He 162 A-2 s motory BMW 003E-1 a dvěma kanóny Mauser MG 151/20 ráže 20 mm. Vyrobená byla i malá série verze A-1 s kanóny MK 108 ráže 30 mm, která se ale jinak od A-2 nijak nelišila. Verze He 162A-9 měla mít motýlkové ocasní plochy. Další uvažované varianty zahrnovaly He 162C s šípovitým křídlem a motýlkovitými ocasními plochami, He 162D s podobnou konstrukcí, jen opačnou šípovitostí křídla. He 162C a He 162D se nedostaly dál, než je polotovar prototypu, který mohl být osazen šípovitými nebo křídly s obráceným šípem, které našli Spojenci když okupovali továrnu ve Schwechatu. Výkony byly skvělé, mnohem lepší než RLM požadovalo. He 162 mohl dosáhnout 890 km/h v malé výšce a 905 km/h ve výšce 5 950 m.

History

The Heinkel He 162 Spatz was a German jet fighter that served with the Luftwaffe in the final months of World War II. The aircraft was also known as the Volksjäger (people's fighter) or, incorrectly, the Salamander (Newt). Serial production started in January 1945 and the main production variant was the He 162 A-2 with BMW 003E-1 engines and two Mauser MG 151/20 20 mm cannons. A small series of the A-1 version with 30 mm MK 108 cannons was also produced, but otherwise it was no different from the A-2. The He 162A-9 version was to have butterfly tail surfaces. Other variants considered included the He 162C with a swept wing and butterfly tail surfaces, the He 162D with a similar design, only with the wings swept in the opposite direction. The He 162C and He 162D did not get further than a prototype prototype that could be fitted with sweep or inverted sweep wings found by the Allies when they occupied the Schwechat factory. Performance was great, much better than RLM required. The He 162 could reach 890 km/h at low altitude and 905 km/h at 5,950 m.

Symbols/Symbols

Drill hole



Vyvrátat

Cyanoacrylate



Vteřinové lepidlo

Remove



Odstranit

Reduce



Zbrousit

Make new



Vyrobít

Option



Volba

Bend



Ohnout

Putty



Tmel

Colour name

Humbrol

Colour name

Humbrol

A	RLM 22 Black	H33	G	Aluminium	H56
B	RLM 21 White	H34	H	RAL 01 Silver	H11
C	RLM 66 Black Grey	H67	I	RLM 24 Blue	H25
D	Gunmetal	H53	J	RLM 23 Red	H60
E	RLM 70 BlackGreen	H241	K	RLM 02 Grey	H240
F	RLM 04 Yellow	H24	L	RLM 26 Brown	H113

Drawings/Výkresy:

The last of the Egles/J.R.Beaman JR. Modelář 2/2006

References/Podklady

Bf 109 in action part.2
Bf 109G/K Kagero
Aero detail 5 Bf 109G
Suomen Ilmailuhistoriallinen Lehti
Jagdwaaffe Bf 109
Internet

Plastic parts/Plastikové díly

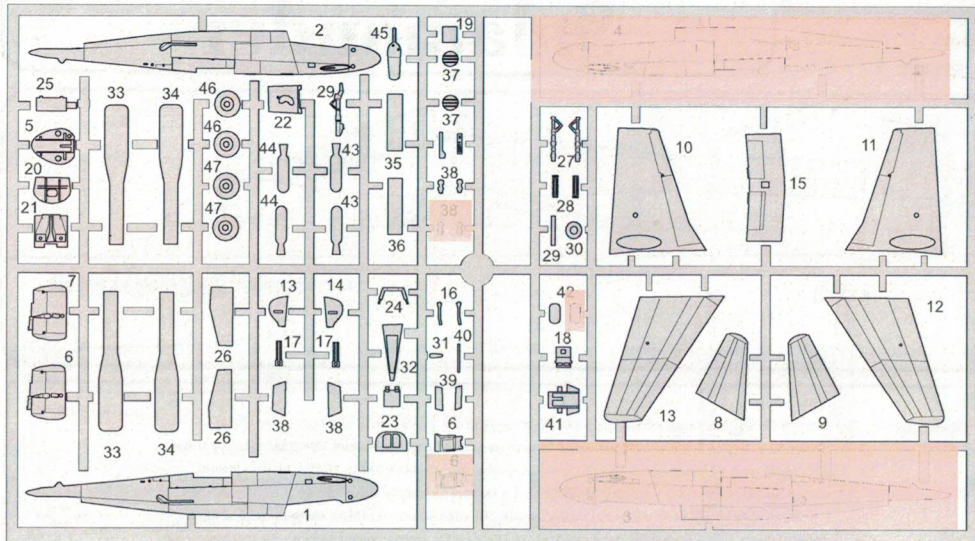

Clear parts/ Průhledné díly

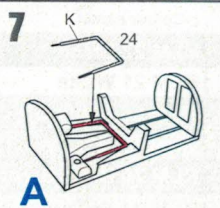
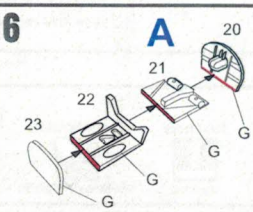
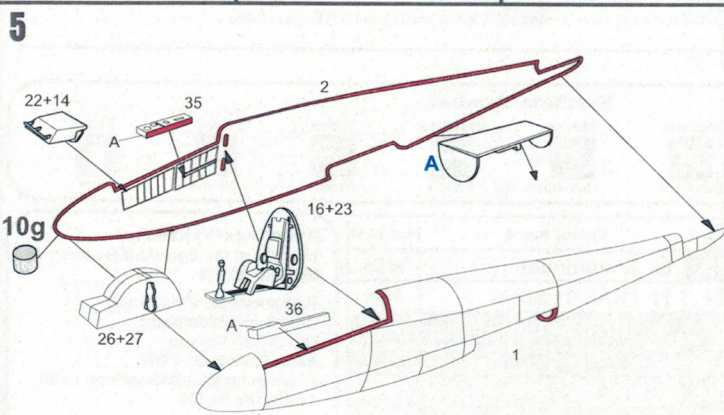
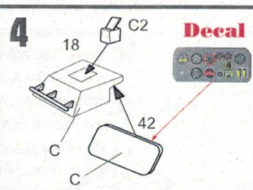
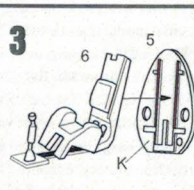
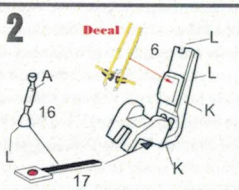
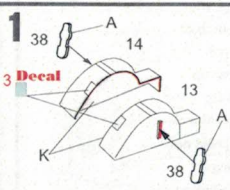
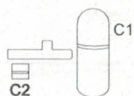

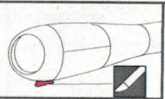
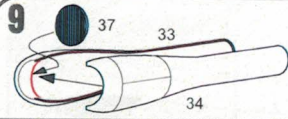

cut off for the B-3 version with two engines

Argus As 109-014 short version

Argus As 109-014 long version

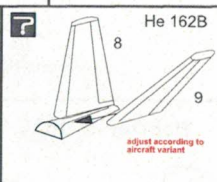
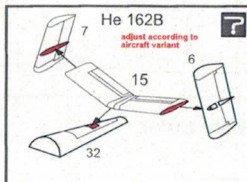
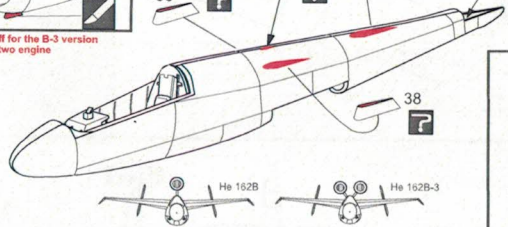
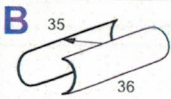
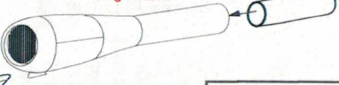
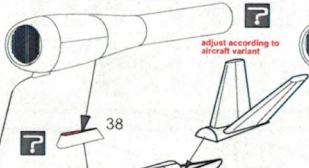

10

adjust according to aircraft variant

adjust according to aircraft variant

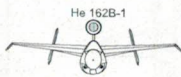
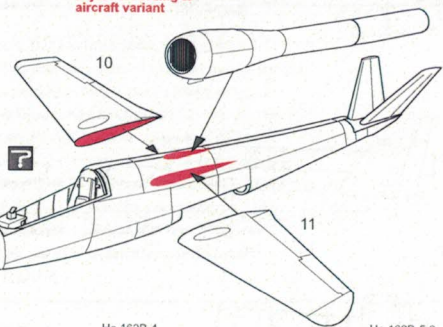
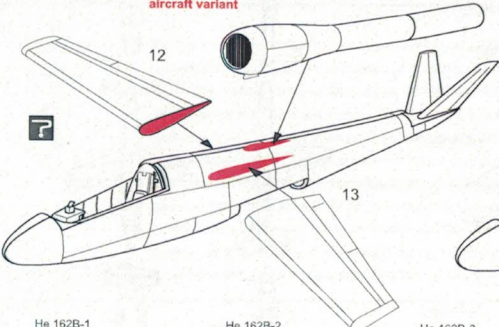

11

Plastic

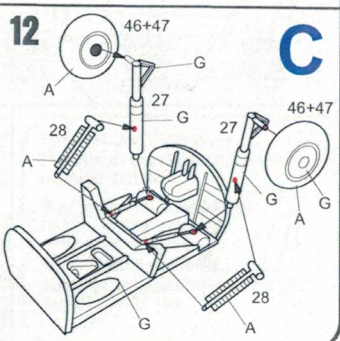
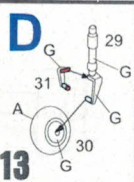
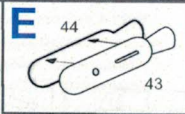
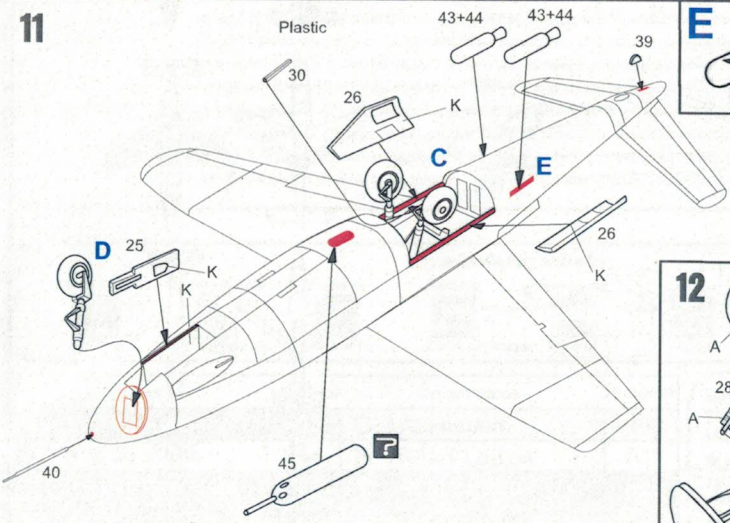

Transparent part
C1

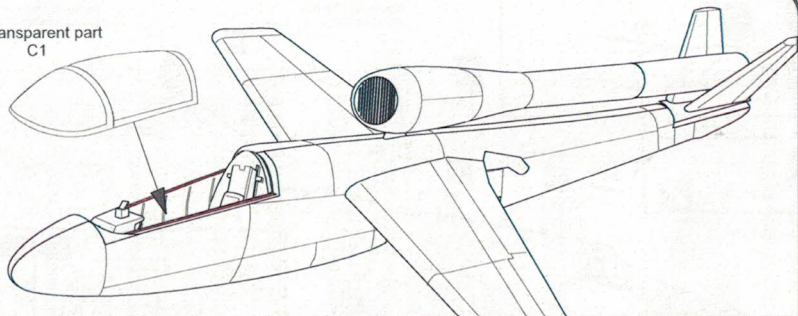

Heinkel He 162B Salamander

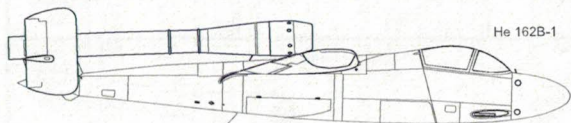

He 162B-1

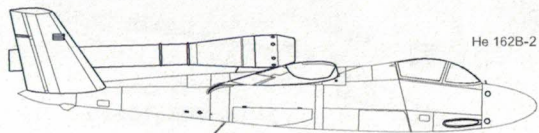

He 162B-2



He 162B-3

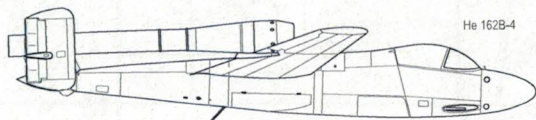

He 162B-4

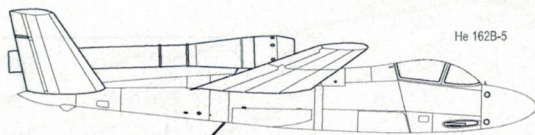

He 162B-5

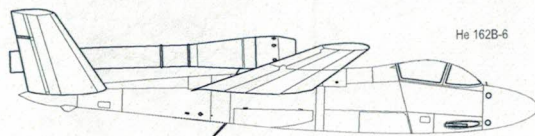

He 162B-6

