



ON TARGET
In the Hangar Series

AIR-GRAPHICS
CS-36
1/72 SCALE



Sikorsky
SH-60B SeaHawk

1:72
Scale

Interior Detail Set

AIR-GRAPHIC MODELS



A

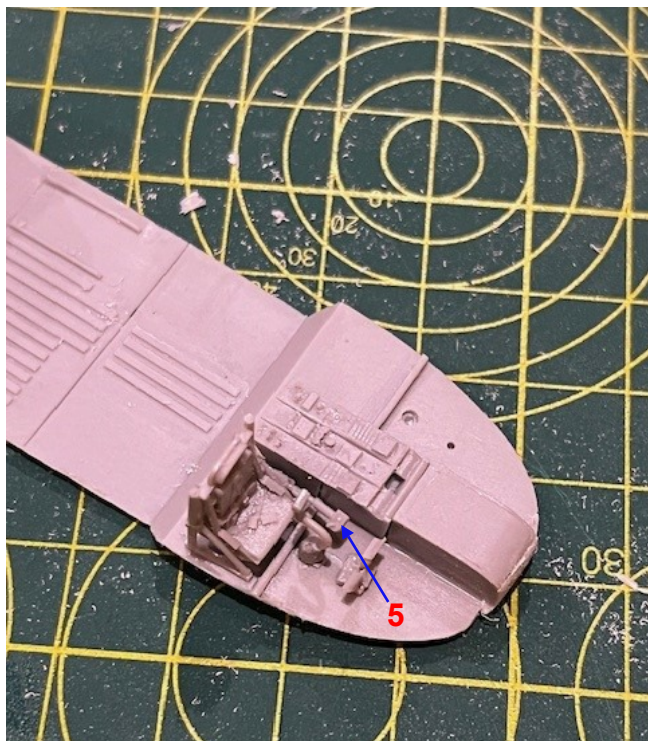
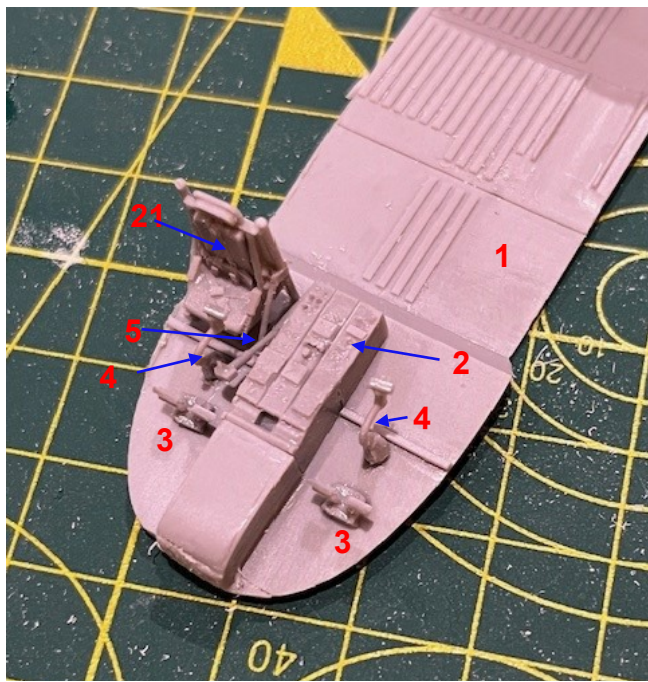

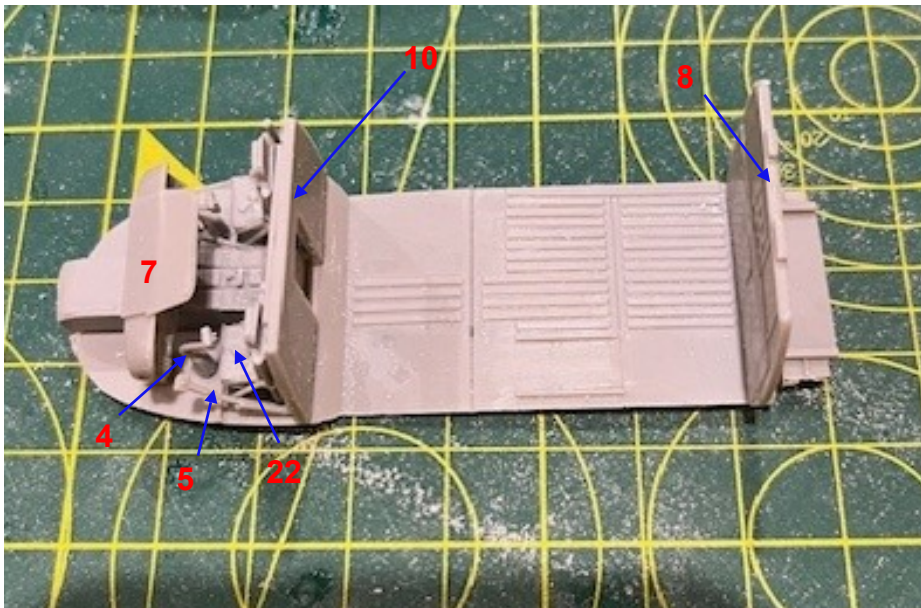
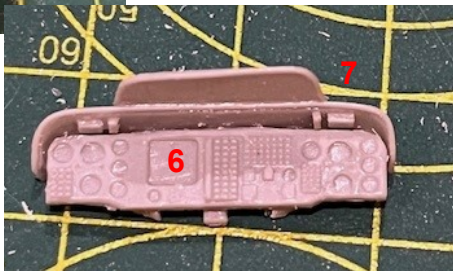

B



Note* Part 9 is the side wall. We recommend you dip this in Hot water and mould into the fuselage half. Please fit roof part 11 Before fixing the side wall.
Ensure the side wall is lined up with the window and then clamp The side wall to the fuselage half until the glue is dry.



C

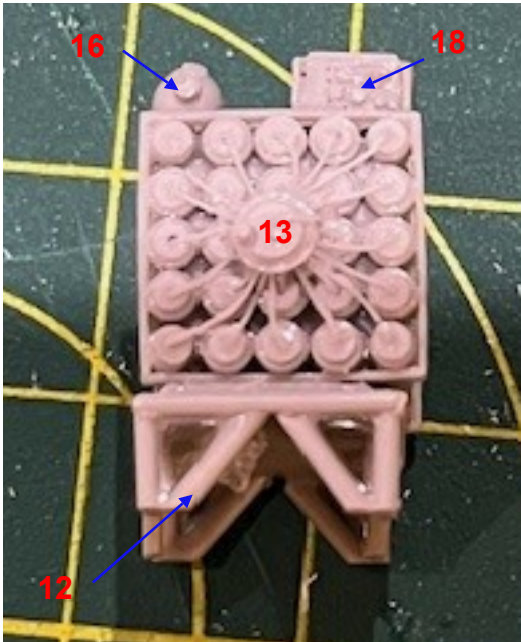

D

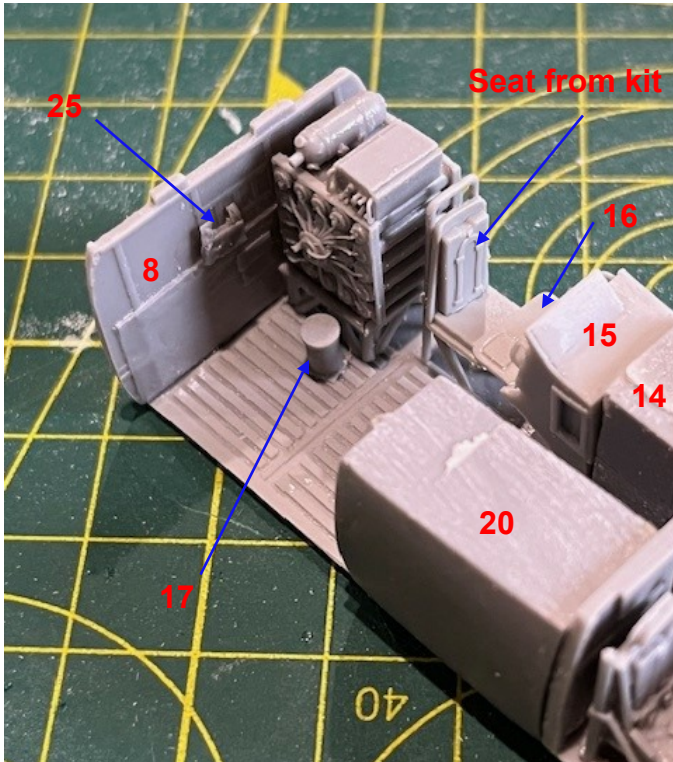
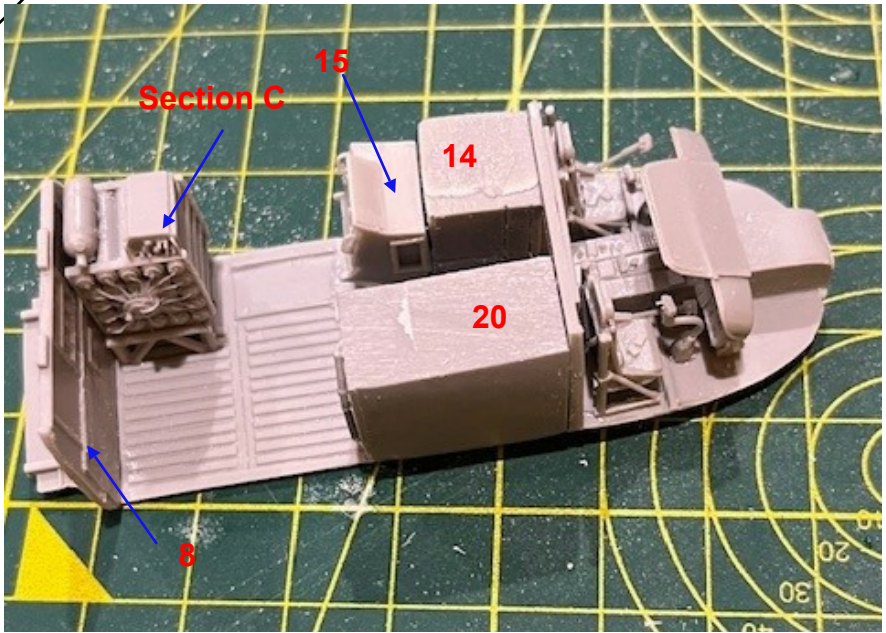

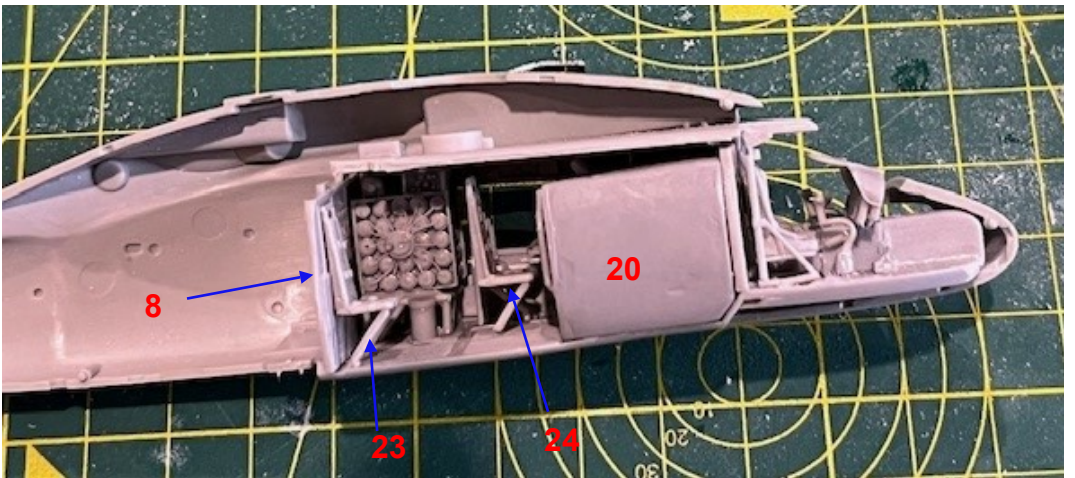
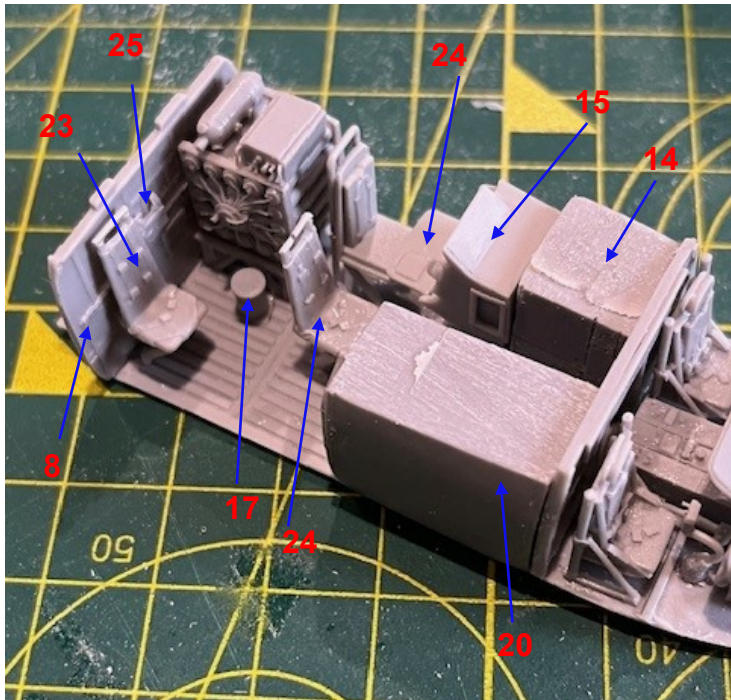

Finished interior fitted into the HobbyBoss SH-60B kit.



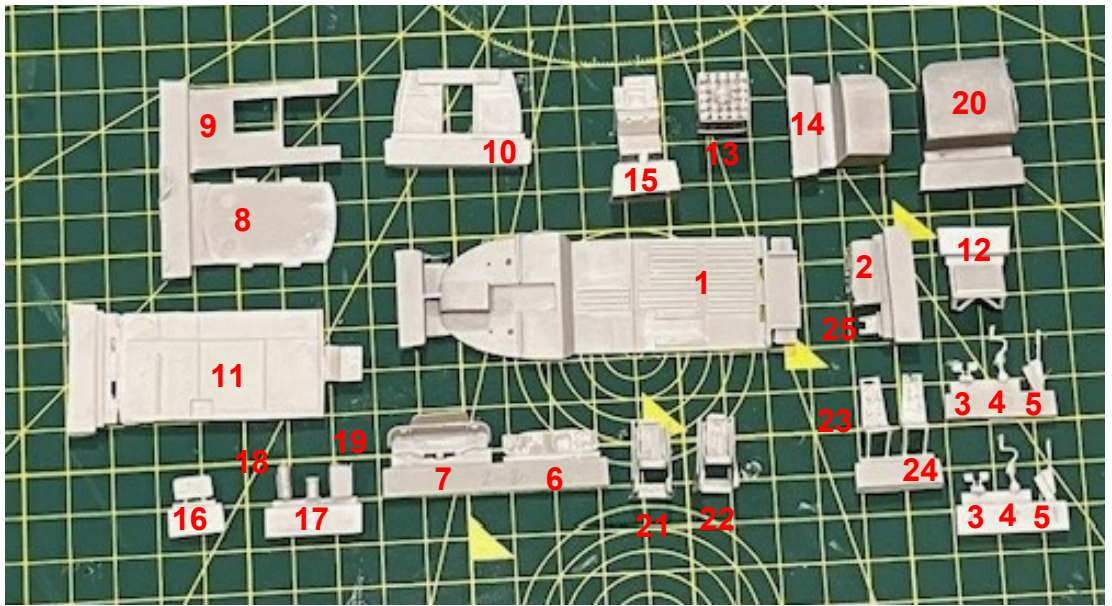

Interior Colours:
 Front cockpit is matt black, floor, walls,
 Instrument panels and seats.
 Rear cockpit is Grey FS 36270 with Blue padded
 Areas as per photos. Seat frames are Grey or Black.



INSTRUCTIONS

- Remove any flash by gently snapping off, or cutting with a scalpel and then lightly sanding.
- Only use Super-glue or a two-part epoxy glue to fix parts.
- Gluing is easier if mating surfaces are slightly sanded to roughen the resin before gluing. Also clean off any dust before gluing.
- Before painting, thoroughly wash all parts in warm water with detergent.
- We recommend the application of a base coat in a light colour to show any blemishes prior to final painting.

WARNING & SAFETY!

- These parts are moulded in polyurethane resin. Please take care when sanding and cleaning up the resin by wearing a dust mask or other protective breathing device to avoid inhalation of the dust particles.
- Wash hands, resin parts and the work surface after sanding resin.
- When using Super-glue or two-part epoxy glue, please take precautions to avoid contact with skin and eyes.
- It is also advisable to wear a mask to avoid breathing in any fumes from the glue or work in a ventilated room.
- The use of barrier creams on hands or wearing disposable gloves, and working in a well ventilated area, is strongly recommended.
- Not suitable for children under 14 years of age.

Thank you for purchasing this Air-Graphics product which forms part of a range of accessories, conversion sets, decals & kits all to 1/72 Scale.

Air-Graphics: 24 Fyfield Close, Wantage, Oxfordshire,
 OX12 8HN, UK
 E: gary.madgwick@air-graphics.co.uk

AIR-GRAPHIC MODELS