

Russian BTR-50PK APC

俄罗斯BTR-50PK装甲运输车

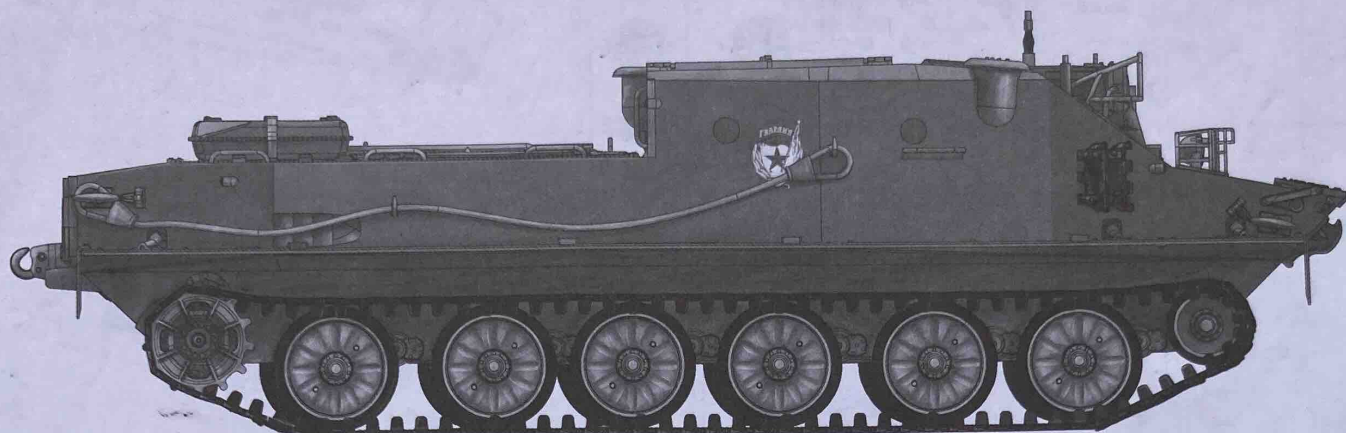

READ BEFORE ASSEMBLY:

- Study and understand these instructions thoroughly before beginning assembly
- When needed, remove photo-etch parts carefully using a modeling knife or photo etch sprue cutter, being careful not to damage or lose small parts.
- Take extra care in handling photo etch parts in order to avoid injury
- Apply instant cement sparingly to photo etch parts where instructed
- Tools recommended(not included in kit):Plastic and instant cements, sprue cutters,long nose pliers,modeling knife, small files, tweezers, pin vise & scissors. Soft cloth and sandpaper will also assist in construction
- Glue and paint are not included in the kit. Use plastic cement and hobby paints only. Color guide for purchasing paint is included in the kit.

装配之前仔细阅读

- 小心用模型锉刀锉平所有零件表面的注射浇口。
- 小心用刀片切下蚀刻片零件，不要遗失小零件。
- 用强力快干胶水粘合蚀刻片零件和金属轴。过量快干胶水使用可能导致可动零件会粘住，小心涂胶。
- 取蚀刻片时应特别注意安全，防止利边划伤手指。
- 某些零件表面需贴水上贴纸，请选择在装配的同时进行。
- 推荐模型工具(自备)：胶水，水口剪刀，长咀钳，刀片，锉刀，镊子，钳，钻，剪刀，瞬间快干胶。
- 软布同砂纸同时也应该是必备工具。
- 请使用塑料胶水和油漆，模型内不含。



配重
Weight



使用强力胶
Cyanoacrylate glue



钻孔
Make hole



切除
Cut / Remove



贴纸
Decal



锉平
File / Sand



选择
Option



不涂胶水
No cement



弯曲
Bend

水贴纸的使用:

- 1.从水贴上剪下印花;
- 2.将印花放入温水中浸10秒,然后放在干净布上。
- 3.拿着印花纸板将印花移到模型上;
- 4.手指蘸水将印花移到适当的位置;
- 5.用软布轻压印花直至水干,汽泡消失

DECAL APPLICATION

- 1.Cut decals from sheet as needed
- 2.Dip the decal in warm water for about 10 seconds and then place on soft clean cloth.
- 3.Hold the decal backing sheet edge and gently slide the decal onto the model in its proper position.

- 4.While still wet,decal can be adjusted for better fit on model by dampening it gently with your finger.
- 5.When placed in the proper position,gently press decal down with a soft cloth until excess water and air bubbles are gone.
- 6.Allow decal to dry completely before handling model

部品图
Parts

AX2

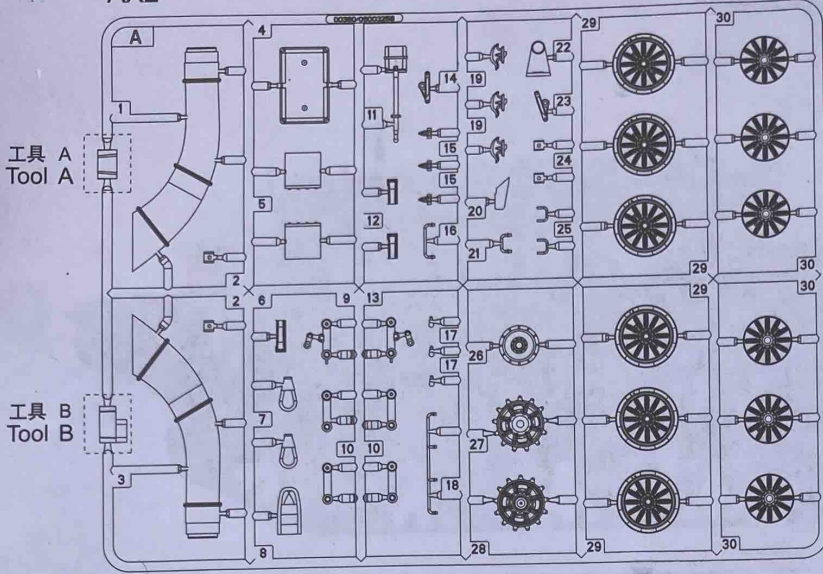

《车底》
Lower hull

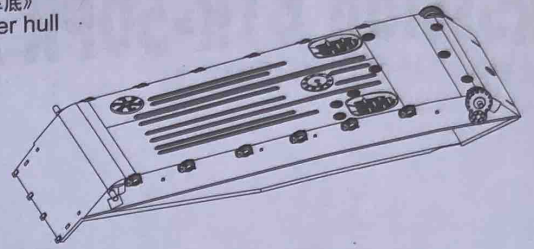

《车面》
Upper hull

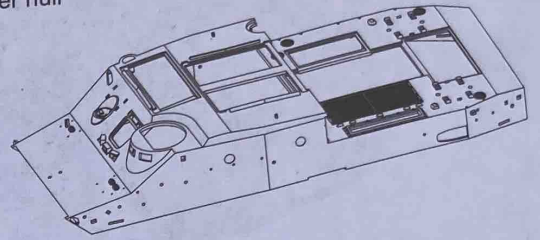

E

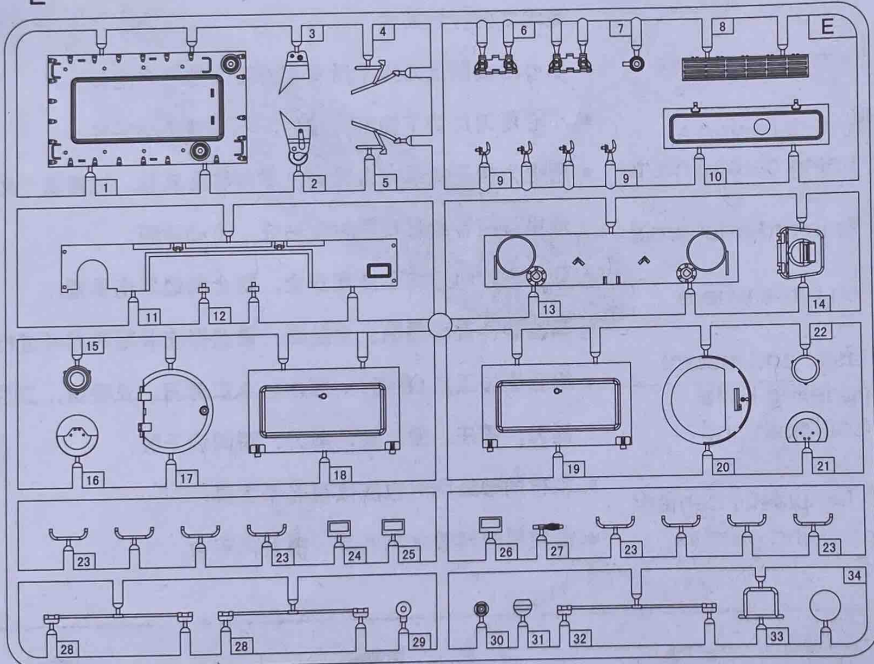

《履带》
Track

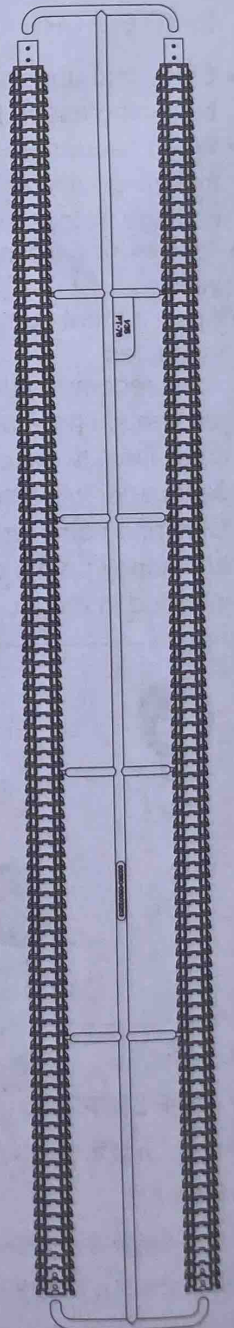

《棉绳》φ1.0x300mm
Rope

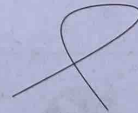

F

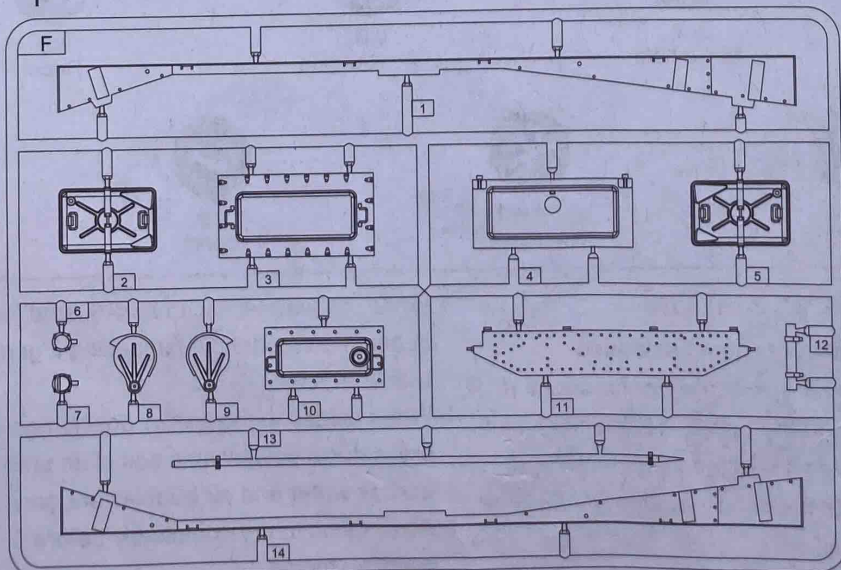

<<蚀刻片>>
Photo etched parts

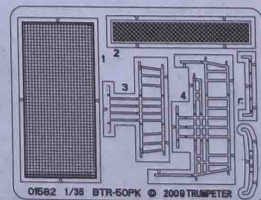

<<水贴>>
Decal



1

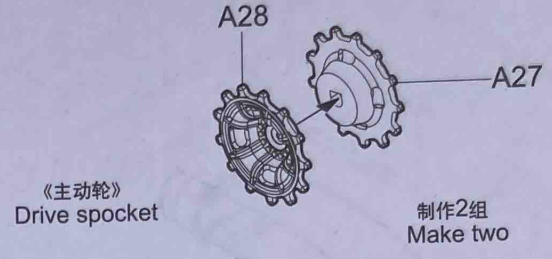
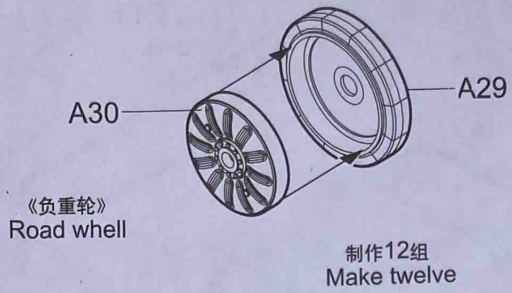

2

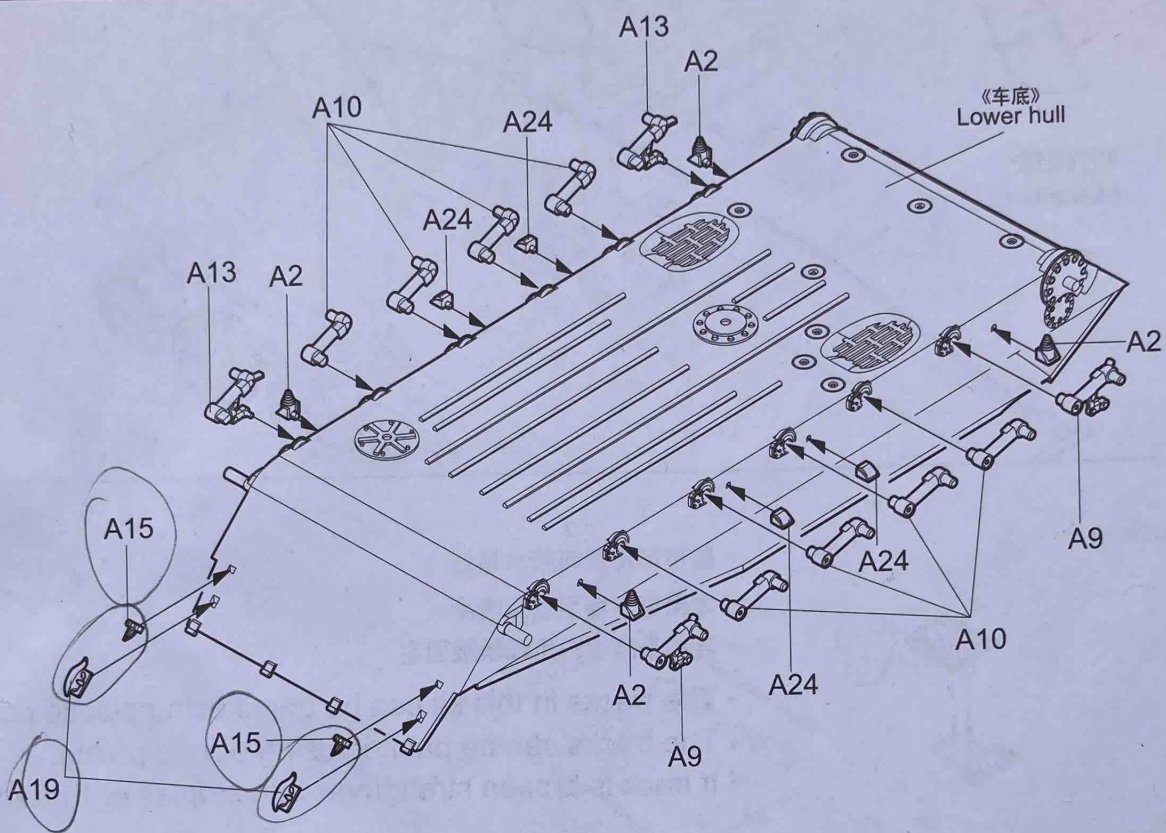

3

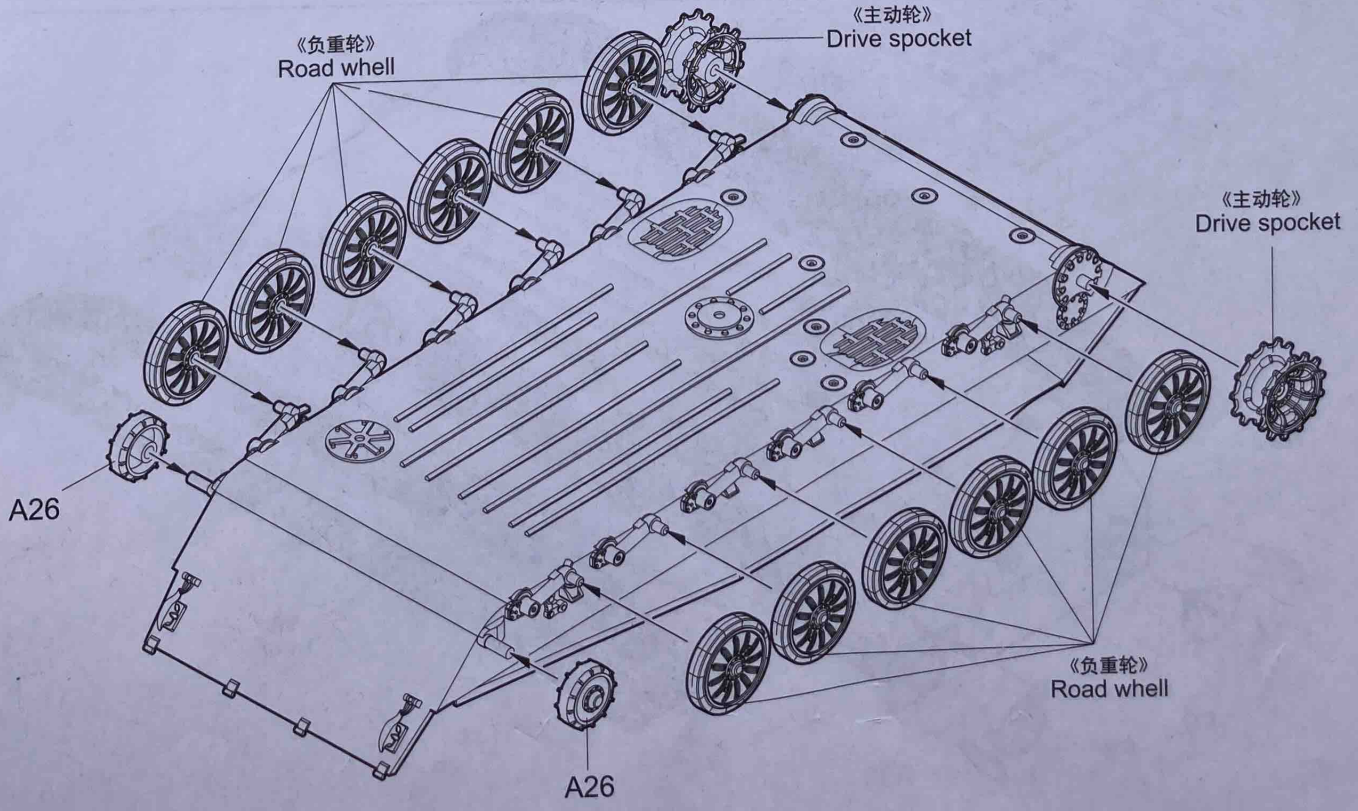

4

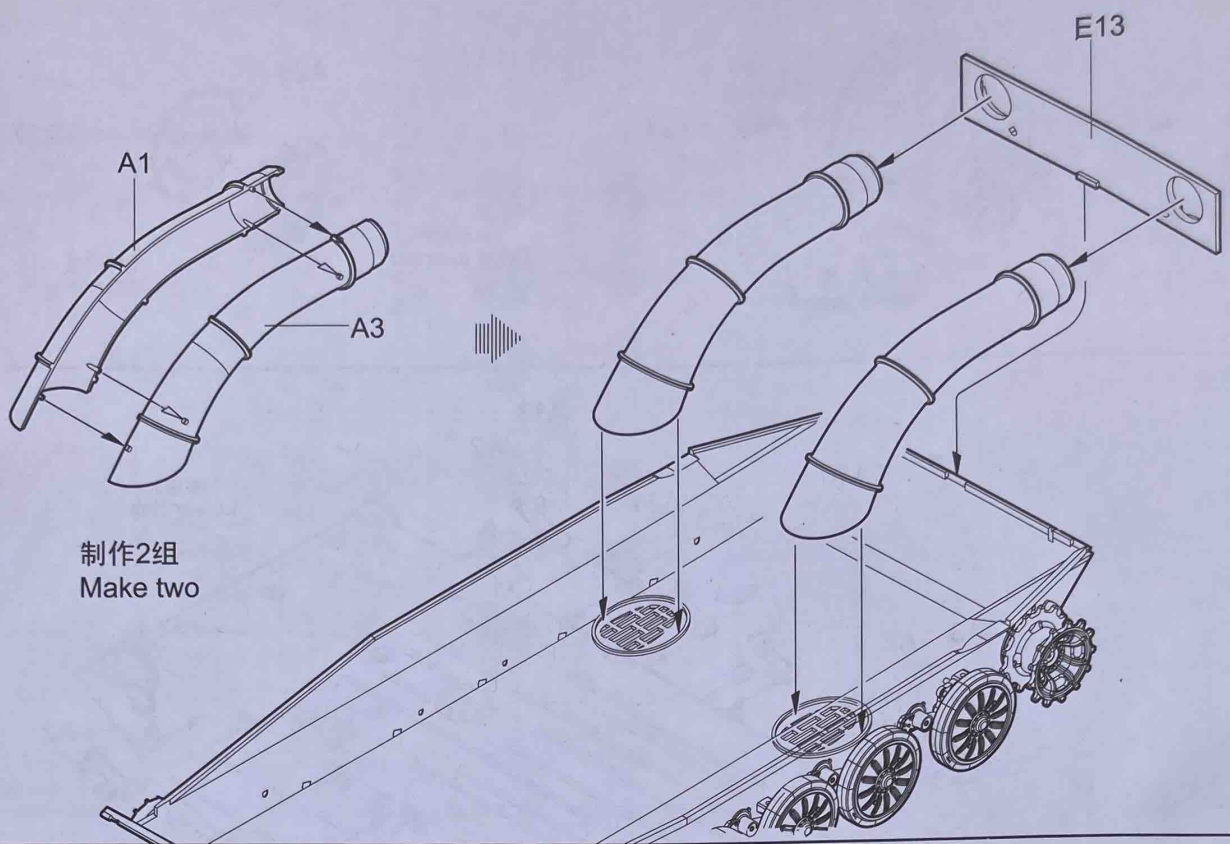

履带的连接
Track construction

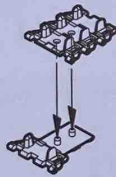

- * 履带可用塑料胶水粘合。
- * 履带可用模型油漆喷涂。
- * 若履带断裂，用细丝线固定。
- * The tracks in this kit can be glued using plastic cement.
- * The tracks can be painted using plastic paints.
- * If track is broken strengthen with staples or thread.

5

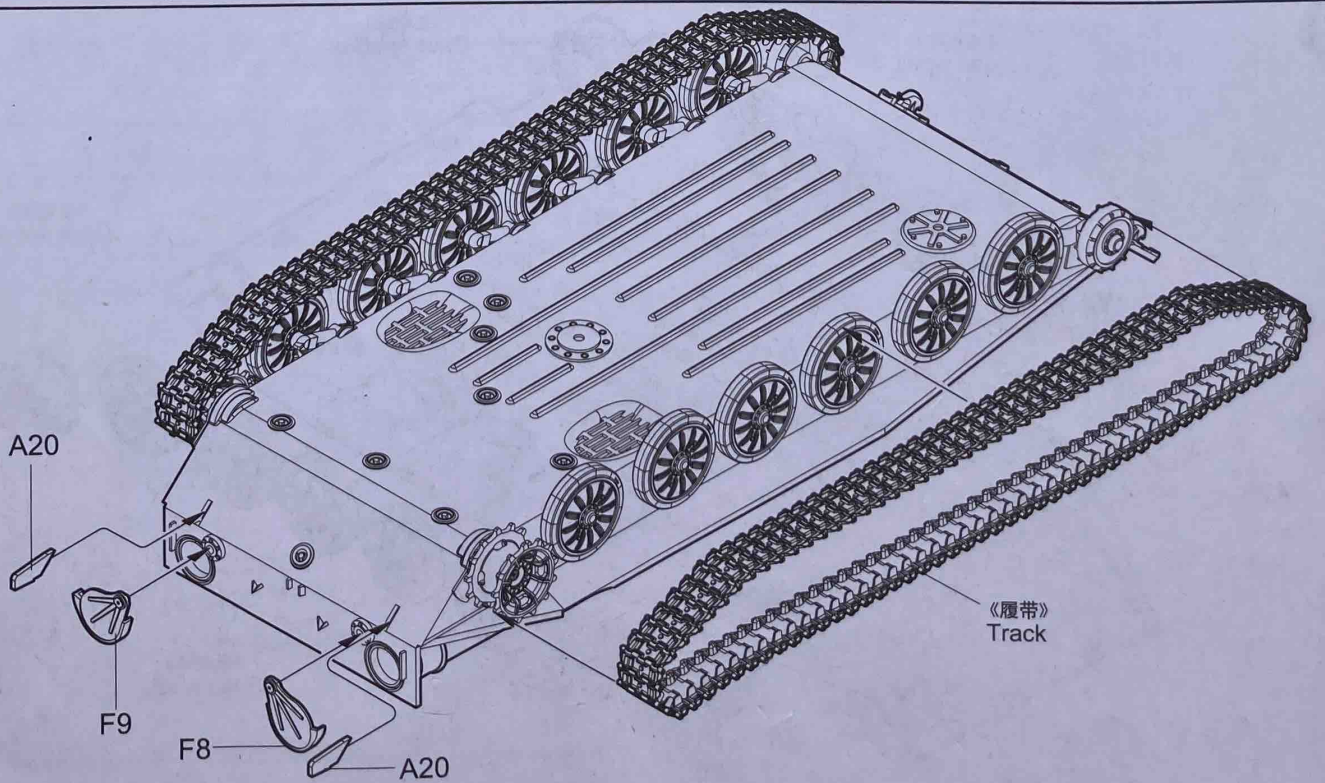

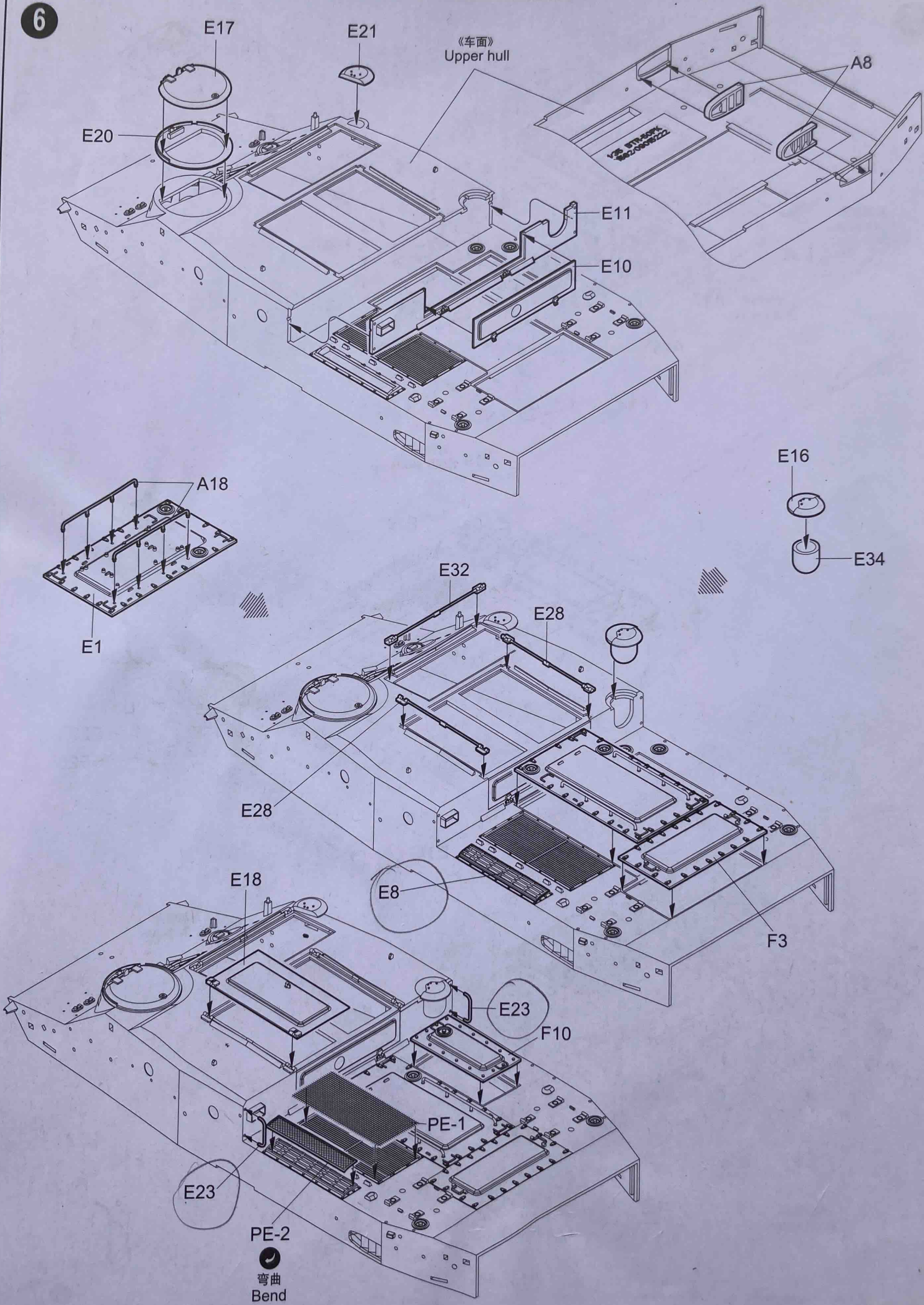

7

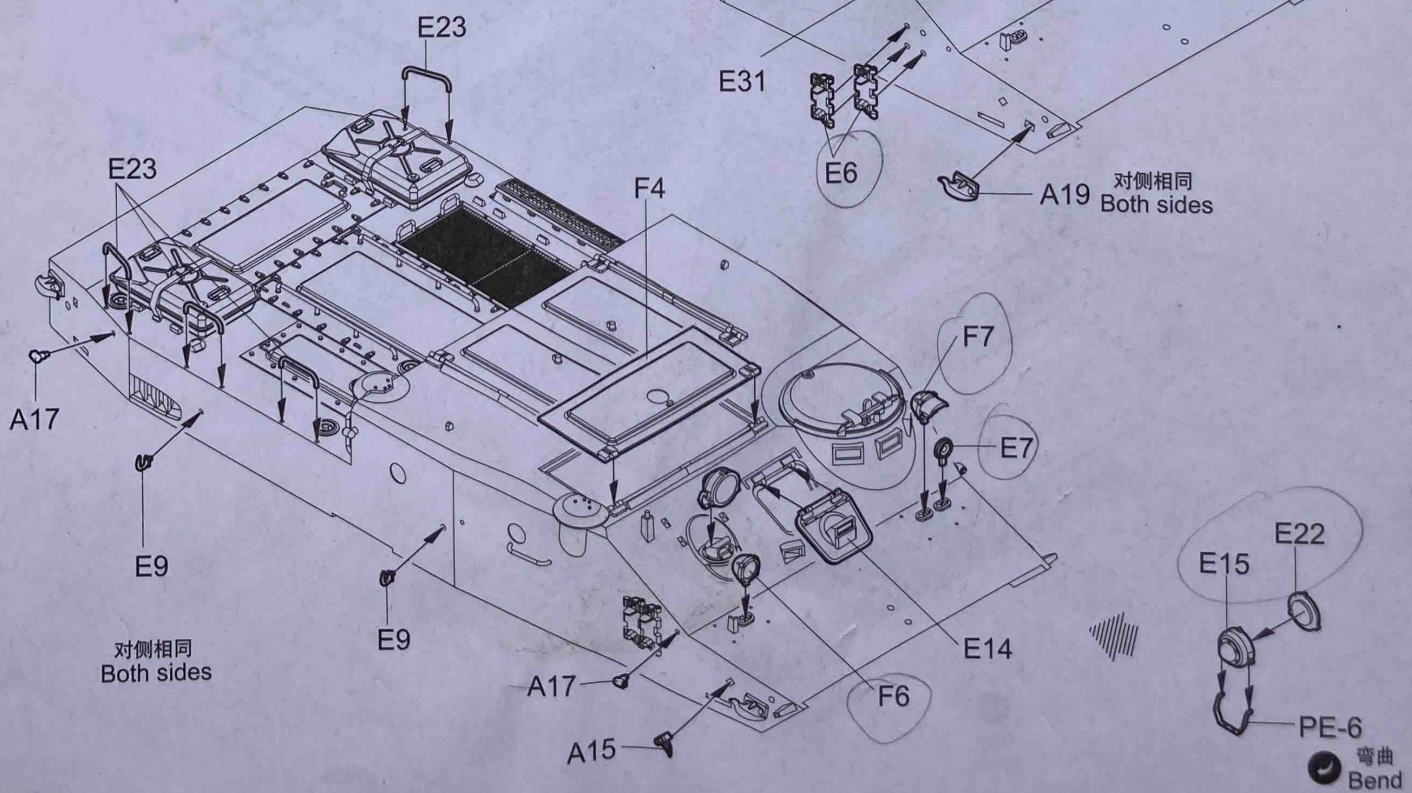
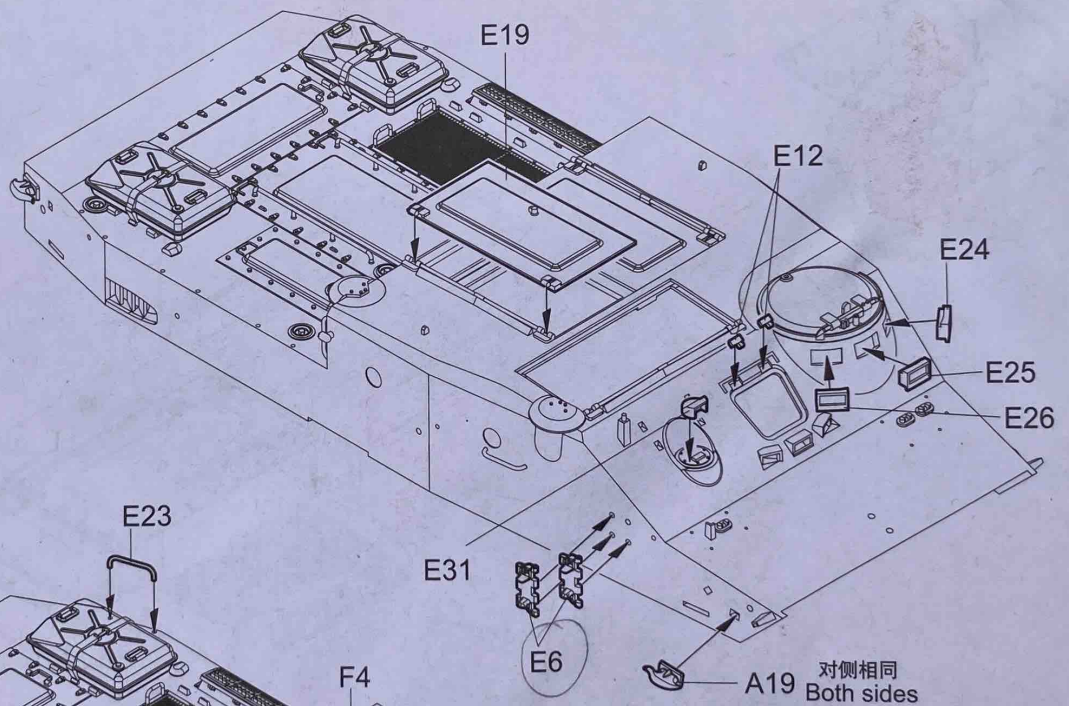
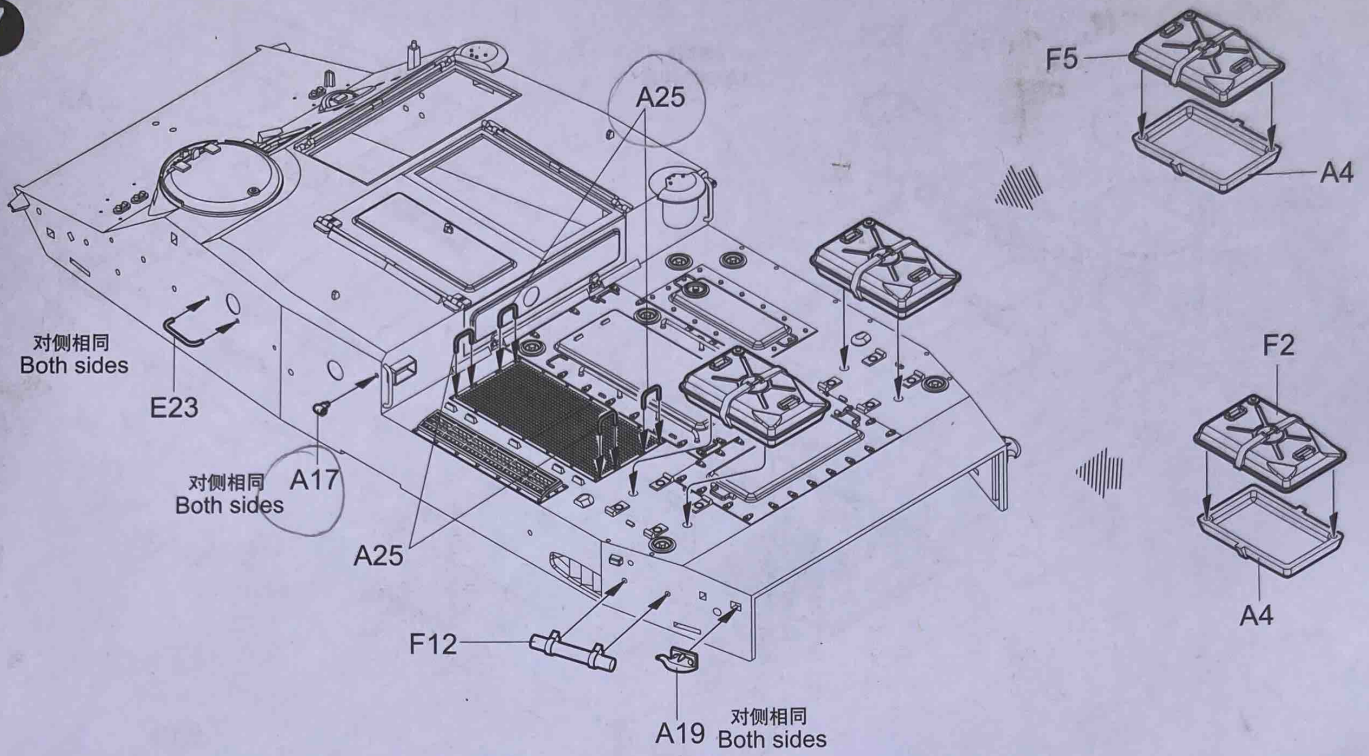

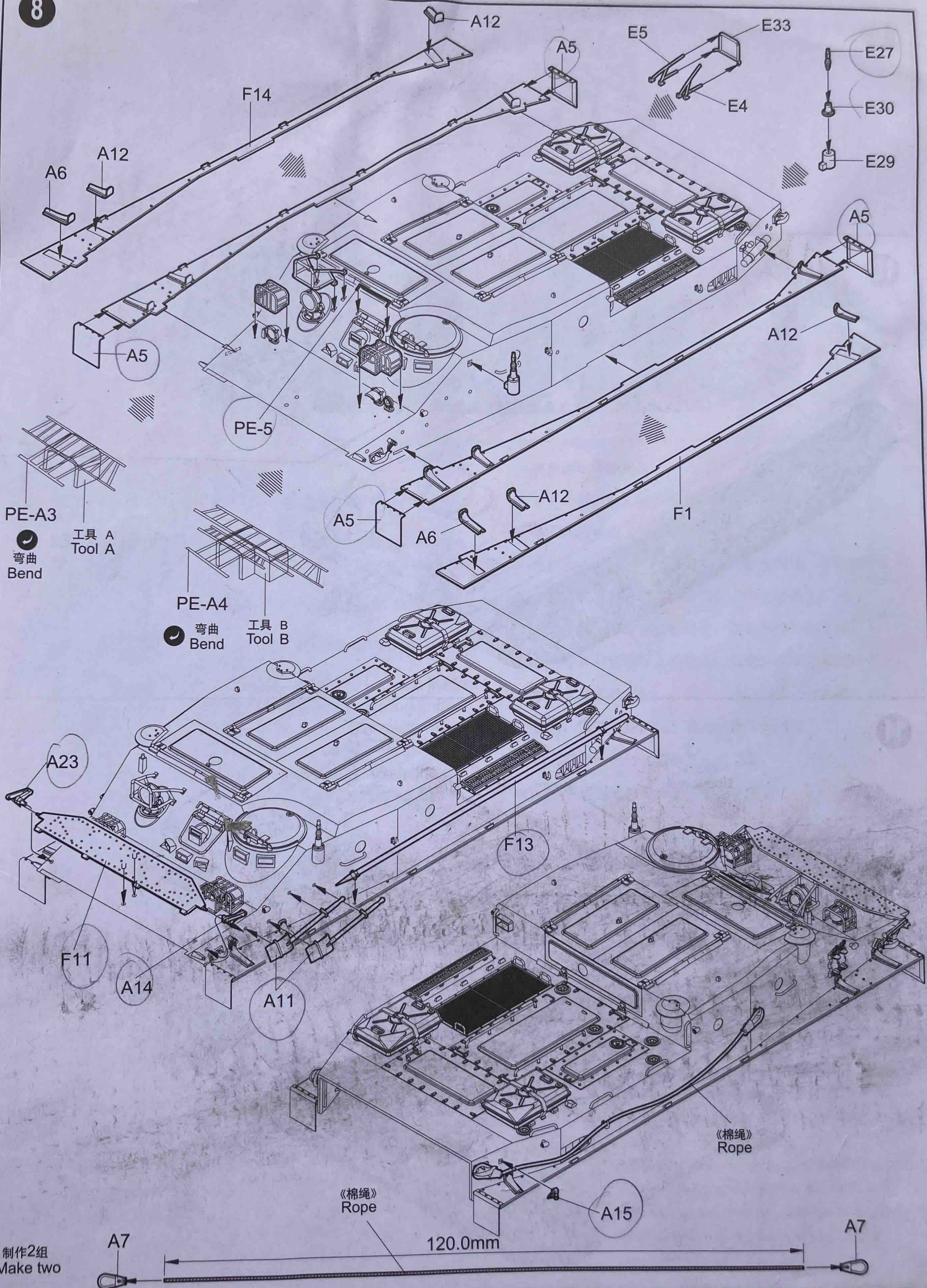

制作2组
Make two

9

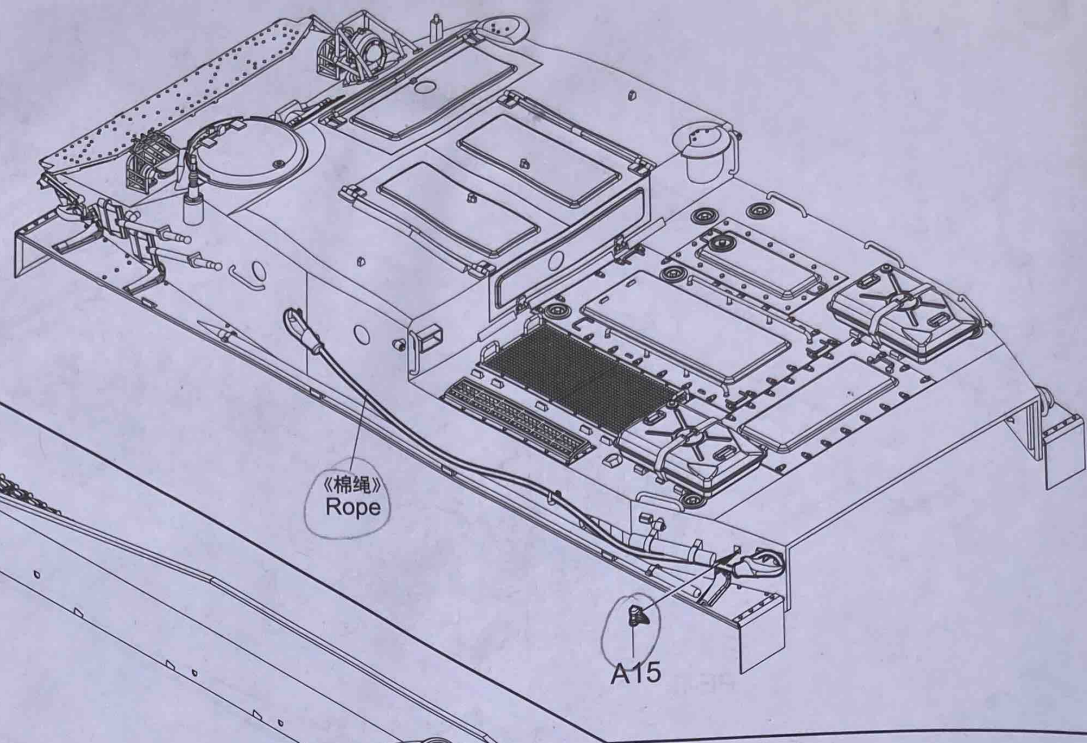

《棉绳》
Rope

A15

10

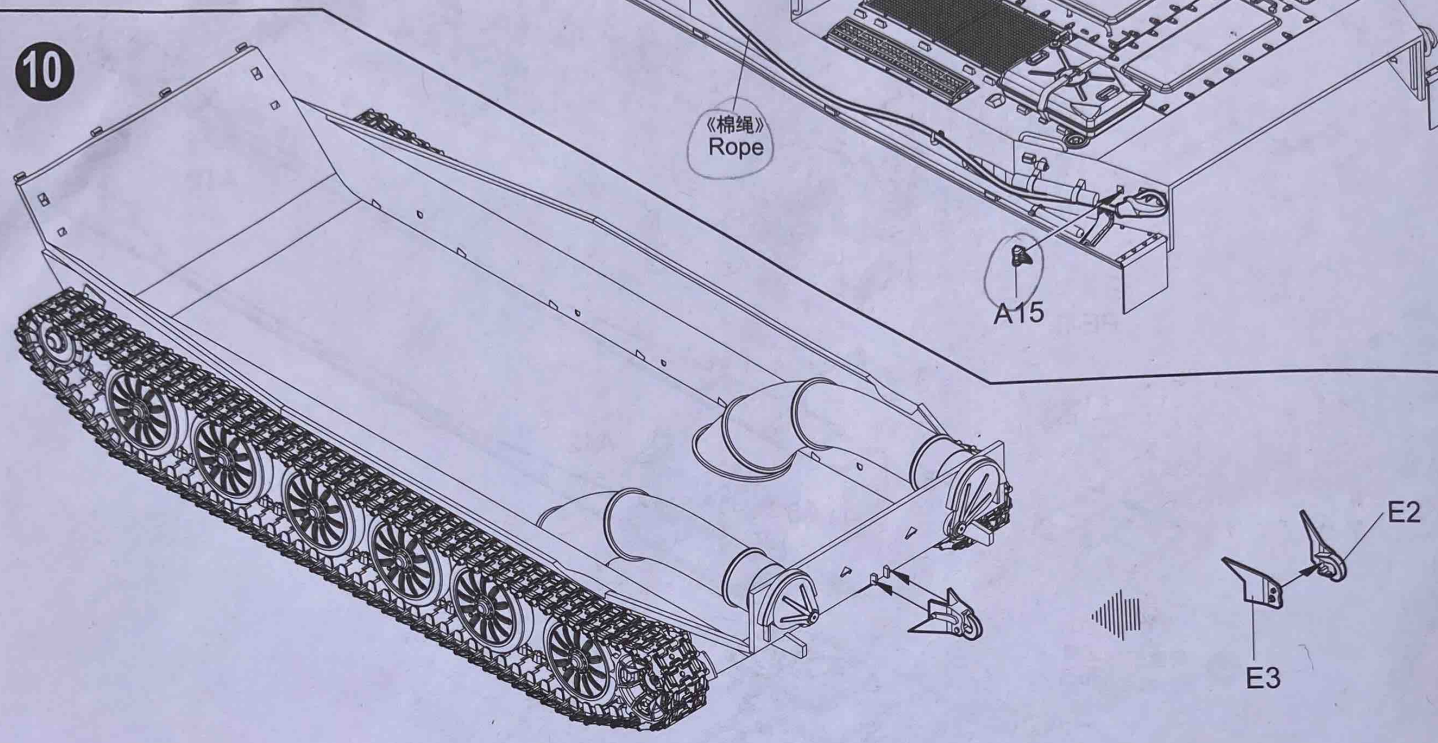

E2

E3

11

《车面》
Upper hull

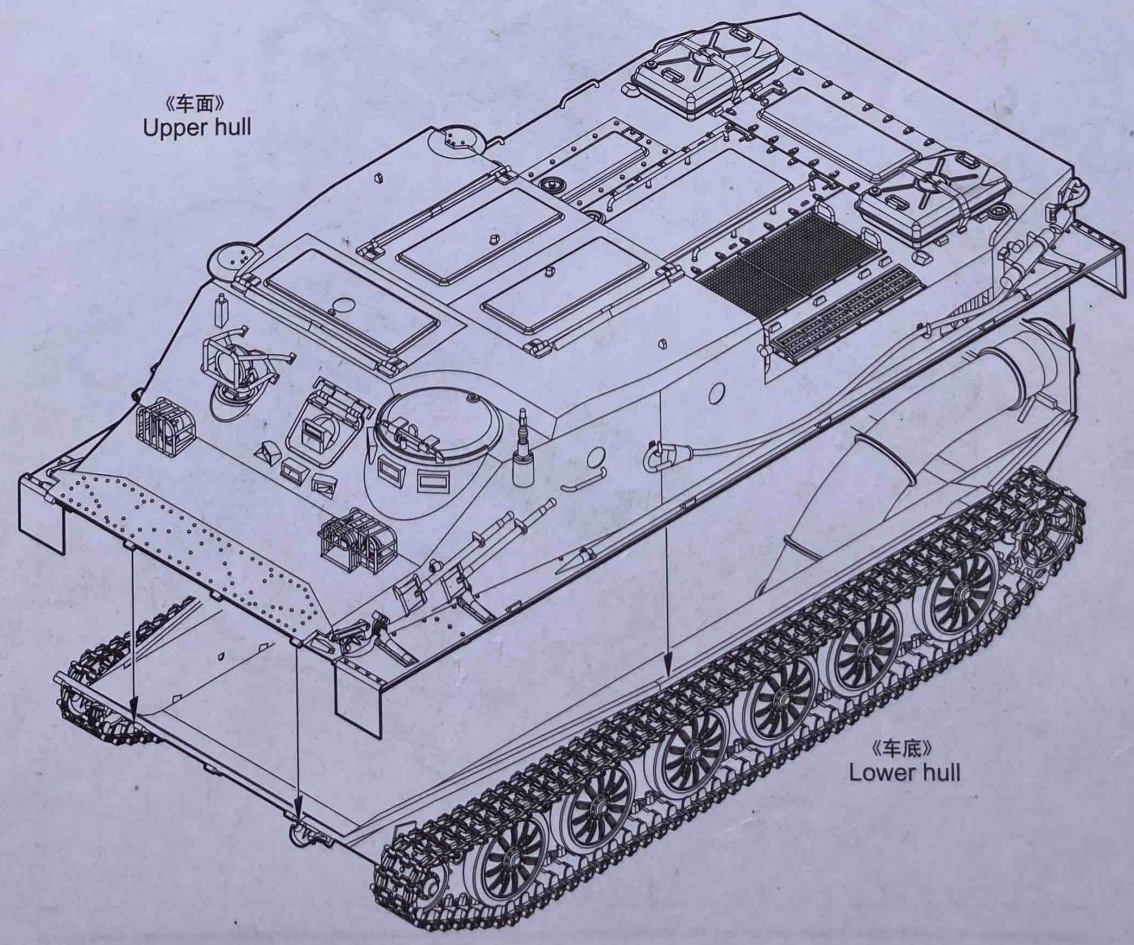

《车底》
Lower hull

涂装同标贴指示 Painting & Marking guide

PAINT REFERENCE COLOUR

Color	Mr.Hobby	Vallejo	Model Master	Tamiya	Humbrol
Tire Black 胎黑色	H 77 137	—	—	—	—
Light Green 绿色	H 303 303	—	1713	XF20	117
Steel (Metal Black) 黑铁色	H 18 28	864	1402	—	—

A

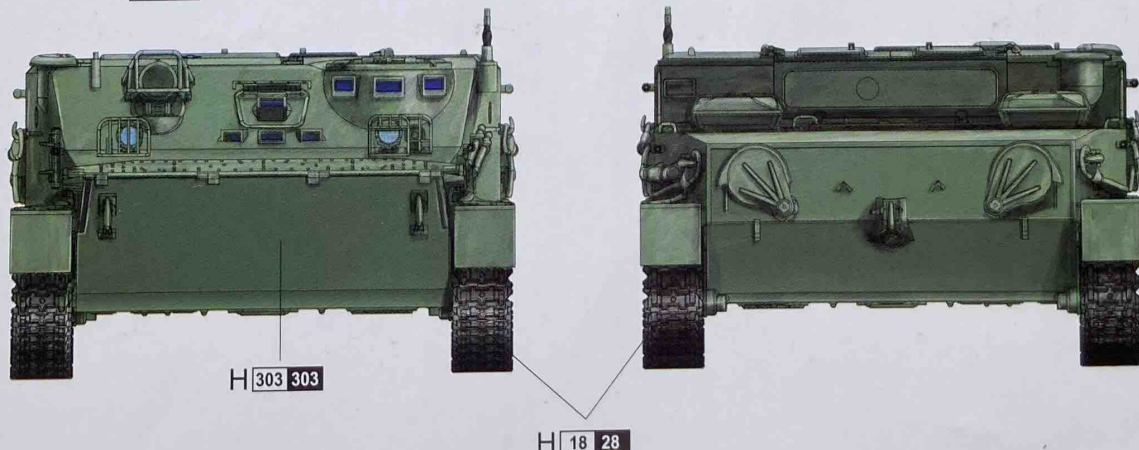
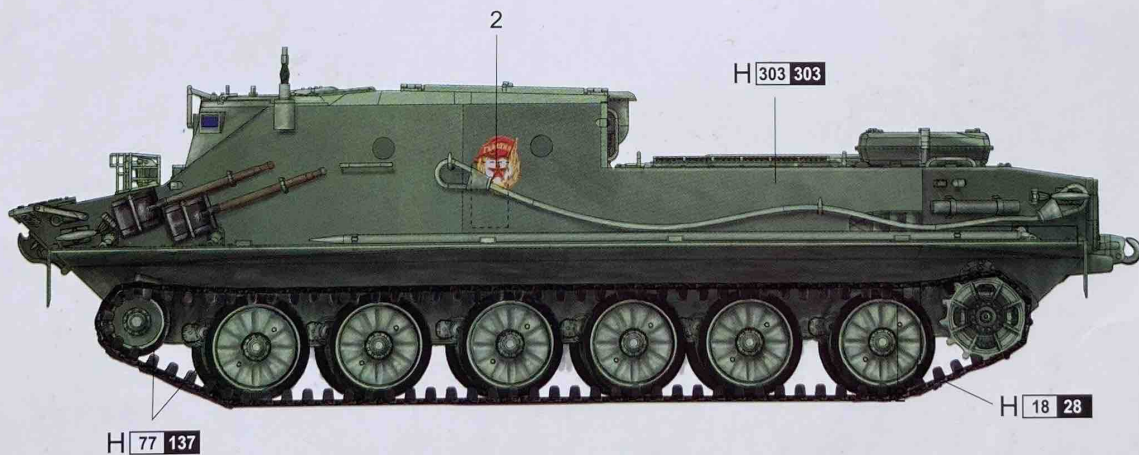
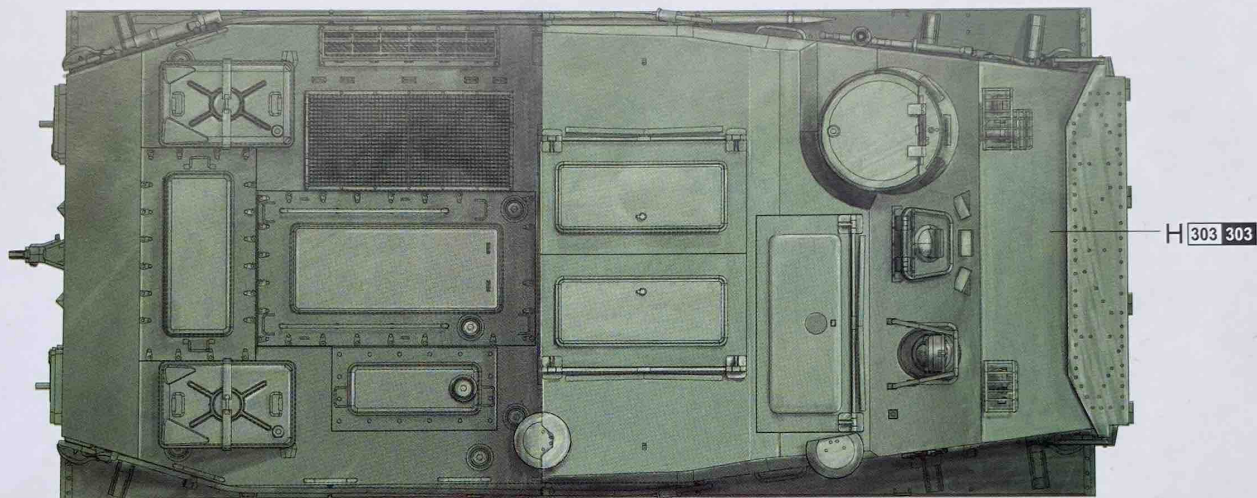

H AQUEOUS HOBBY COLOR ■ Mr. COLOR

涂装同标贴指示 Painting & Marking guide

B

PAINT REFERENCE COLOUR

Color	Mr.Hobby	Vallejo	Model Master	Tamiya	Humbrol
Tire Black 胎黑色	H 77 137	—	—	—	—
Light Green 绿色	H 303 303	—	1713	XF20	117
Steel (Metal Black) 黑铁色	H 18 28	864	1402	—	—

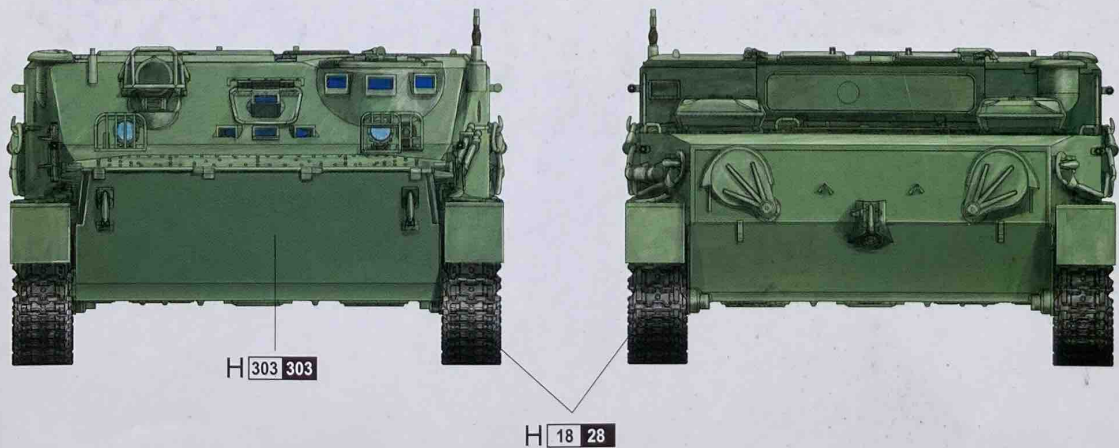
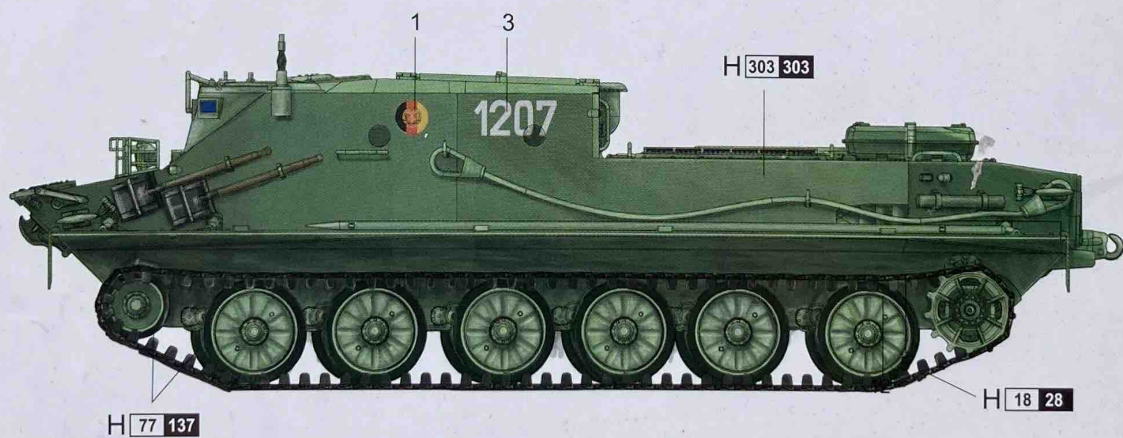
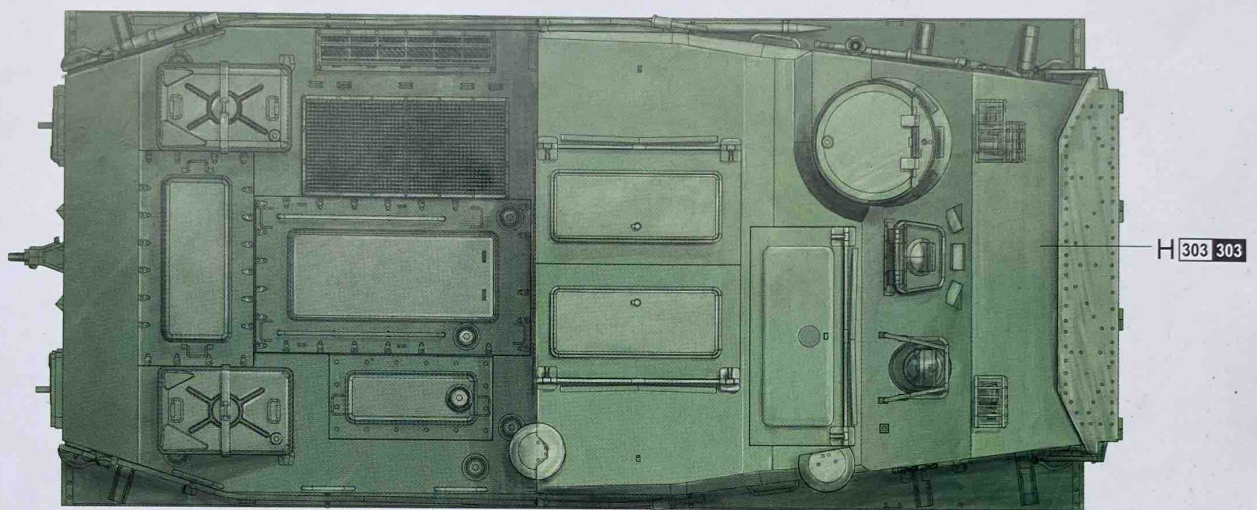

H AQUEOUS HOBBY COLOR ■ Mr. COLOR