

info view

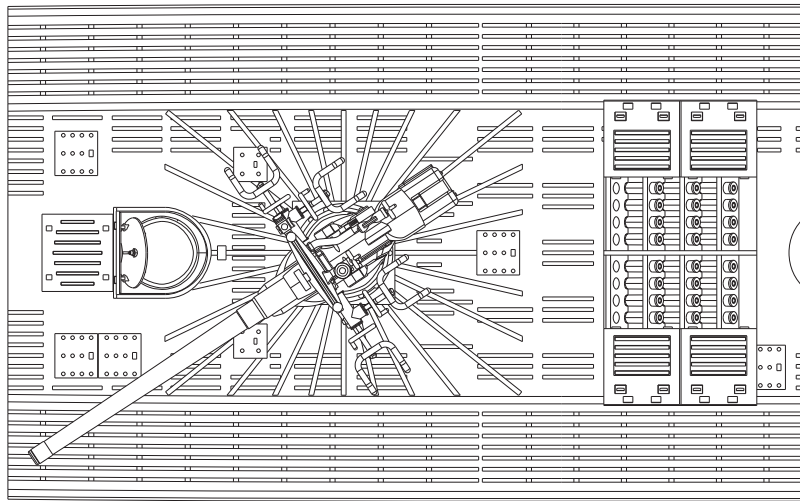

U-Boot typ IXC interior and exterior sets for 1/72 scale Revell U-Boot typ IXC kit

Other sets:

- N72010 U-Boot typ IXC Opened Front and Rear Torpedo Muzzle Doors
- N72011 U-Boot IX Front Torpedo Section
- N72012 U-Boot typ IXC Rear Torpedo Section & Crew Bunks
- N72013 U-Boot typ IXC Exterior Set Part I
- N72017 U-Boot typ IXC Engine Section
- N72018 U-Boot typ IXC Weapon Set Single 37 mm & 2 twin 20 mm AA cannon
- N72019 U-Boot IX Bow Torpedo w/Loading Winch and Cart
- N72020 U-Boot typ IXC Weapon Conversion Set - New 105mm Cannon and Flak Vierling (4x20 mm)
- N72021 U-Boot typ IXC Exterior Set Part II
- N72023 U-Boot typ IXC Flak Vierling 20mm (4x20mm)
- N72024 U-Boot IX Electric Motor section
- N72025 WW II German Torpedo Type G7e (3 pcs)
- N72026 WW II German Torpedo Type G7a (3 pcs)
- N72027 WW II Diesel Engine MAN M9V46 for UIXC
- N72028 U-Boot VII-IX Ammo and Food Supplies
- N72029 U-Boot IX Stern Torpedo w/Loading Winch and Cart

....more at

www.cmkkits.com
www.specialhobby.eu



N72013

special
HOBBY

U-Boot IX Exterior Set Part I

Highly detailed upgrade set
Hochdetailliertes Upgrade-Set
Detailní doplňková sada

For Kit:
U-BOOT typ IXC
Revell 1/72

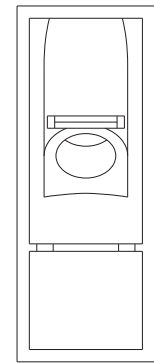

1

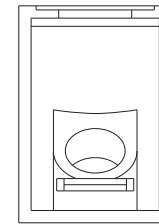

2

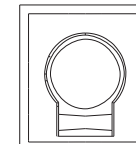

3

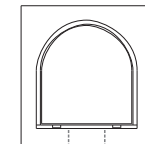

4

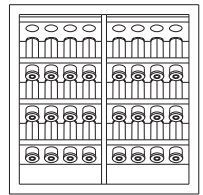

5

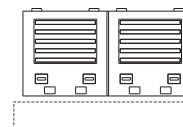

6

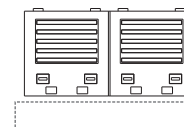

6

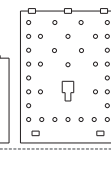

7

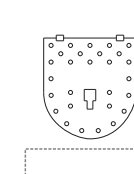

8

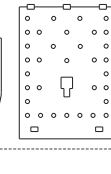

7

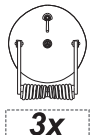

3x
9

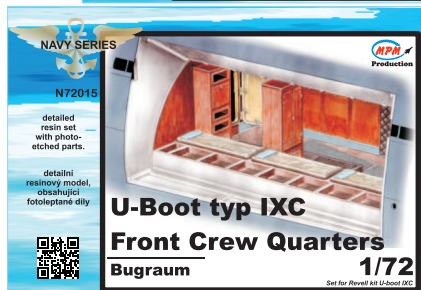
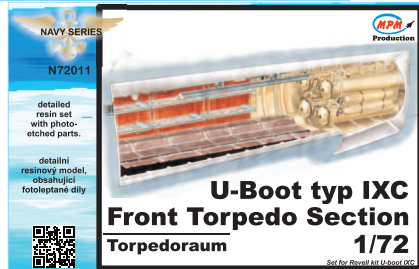
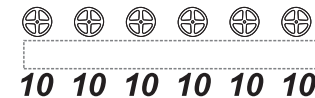

CMK Micro Saw
Mikrosäge

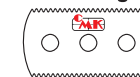

Wires and plastic profiles
are not included in the set
Draht und Plastikprofile sind
nicht Bestandteil dieses
Upgrade-Sets
Dráty a plastikové profily
nejso součástí stavebnice

Special Hobby s.r.o.
Mezilesí 718, Praha 9, 193 00 CZECH REPUBLIC
www.cmkkits.com / www.specialhobby.eu
e-mail: office@specialhobby.eu

Step 1

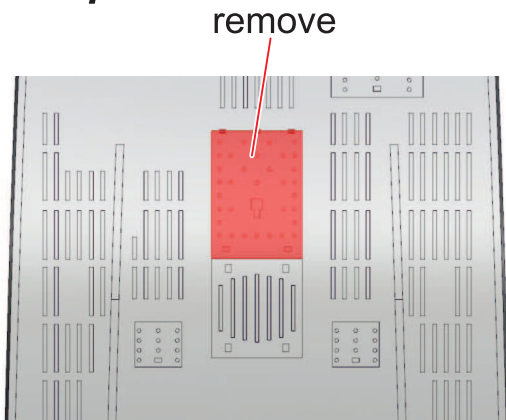

Step 2

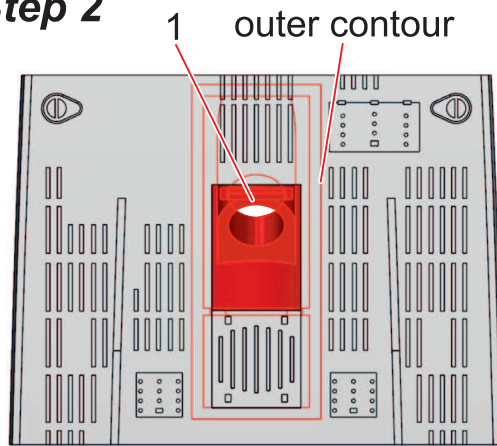

Step 7

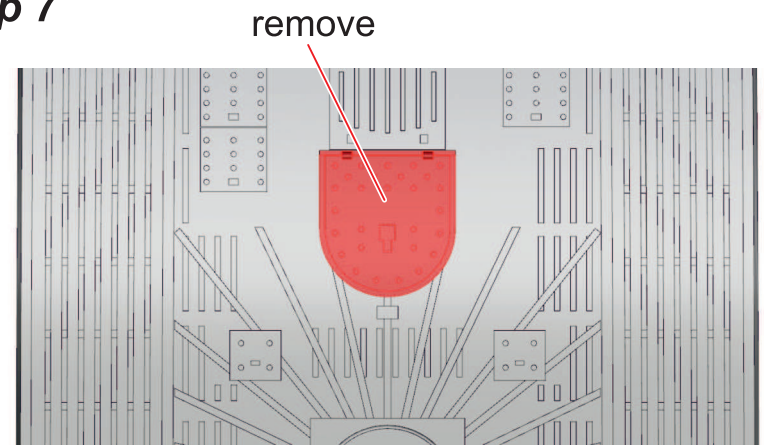

Step 3
3x

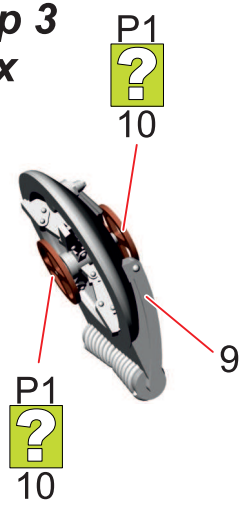

Step 4

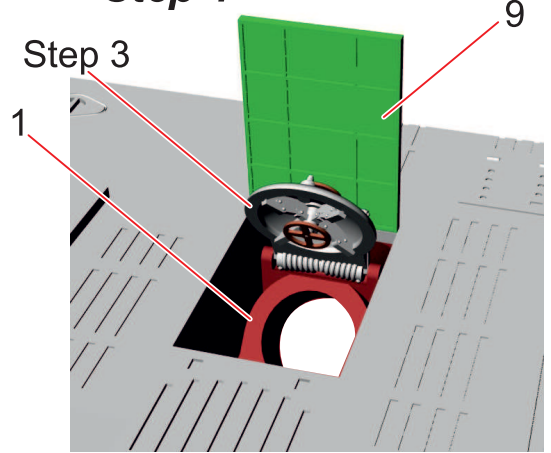

Step 8

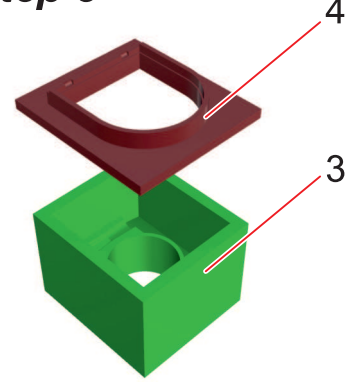

Step 9

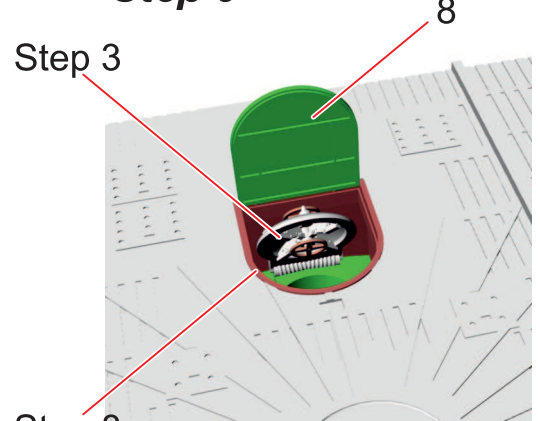

Step 5

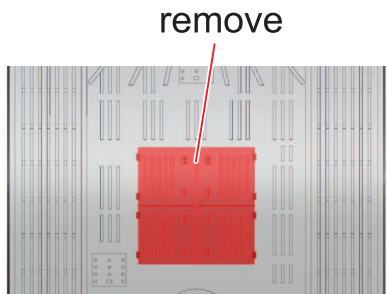

Step 6

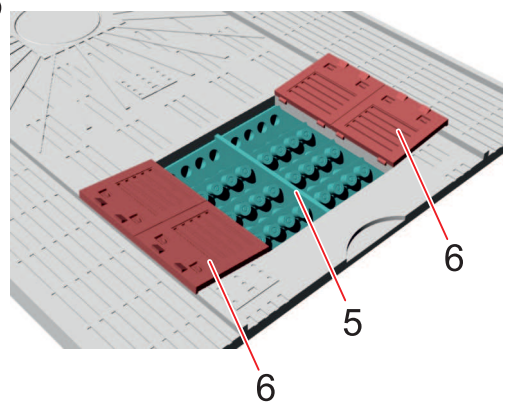

Step 10

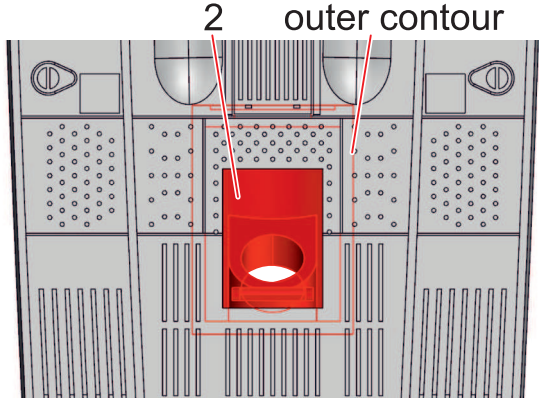

Step 11

