

1/35 MILITARY MINIATURE VEHICLE UPGRADE SERIES PE35193

WWII German Sd.Kfz.232 8ROD early version

二战德军Sd.Kfz.232 8轮重型装甲车早期型改造件

[For DRAGON 6464]

■ 推荐使用工具 RECOMMENDED TOOLS

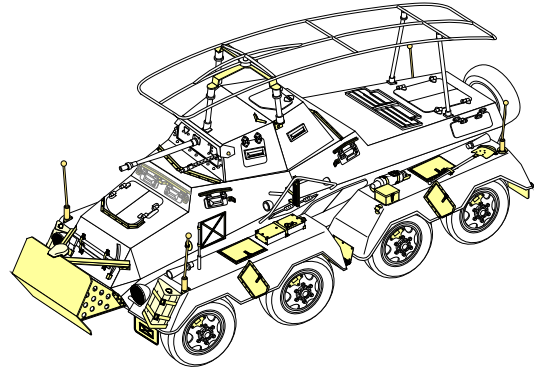
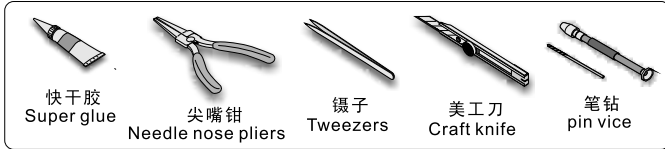

- 安装
install
- 折叠
bend
- A1**
改造件零件编号
PE/resin part number
- B12**
原零件编号
kit part number
- C22**
被替换的原零件编号
replaced kit part number
- 切除
remove
- 打磨
grind off
- 弧度卷曲
radial bending
- x2**
制作若干组
multiple assembly
- 另一侧相同制作
repeat on opposite side
- 选择安装
alternative
- 注意
caution
- 扩孔
ream
- 钻孔
drill
- 填补
fill

用尖端在凹槽处冲压
use penpoint to press on the dent

圆珠笔
Ballpen

蚀刻片零件内侧面向上
PE part inboard side turn up

用笔尖在凹槽处划
Use penpoint scratch on the flute

金属件
Metal part

C x8

1/35 MILITARY MINIATURE VEHICLE UPGRADE SERIES PE35193

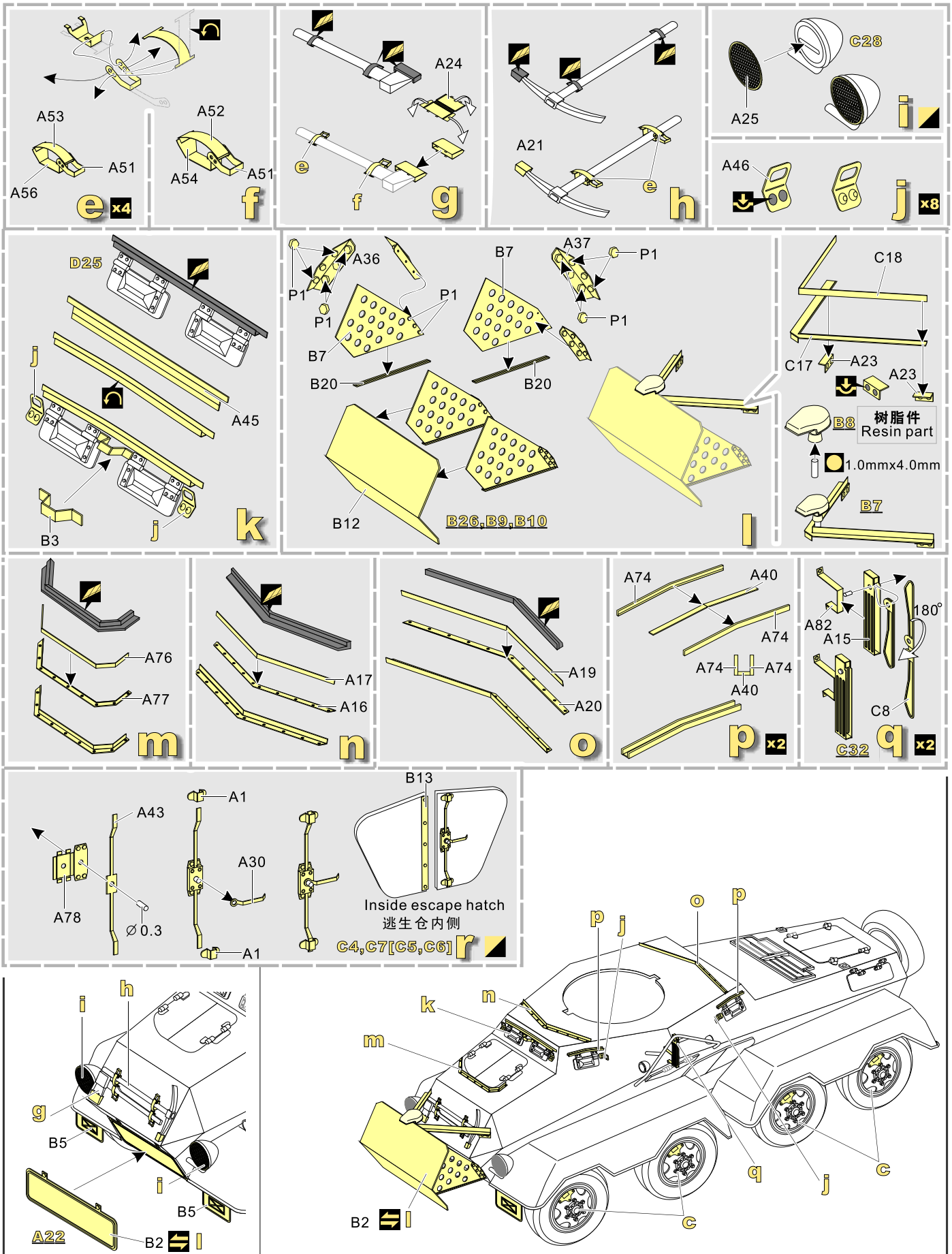

1/35 MILITARY MINIATURE VEHICLE UPGRADE SERIES PE35193

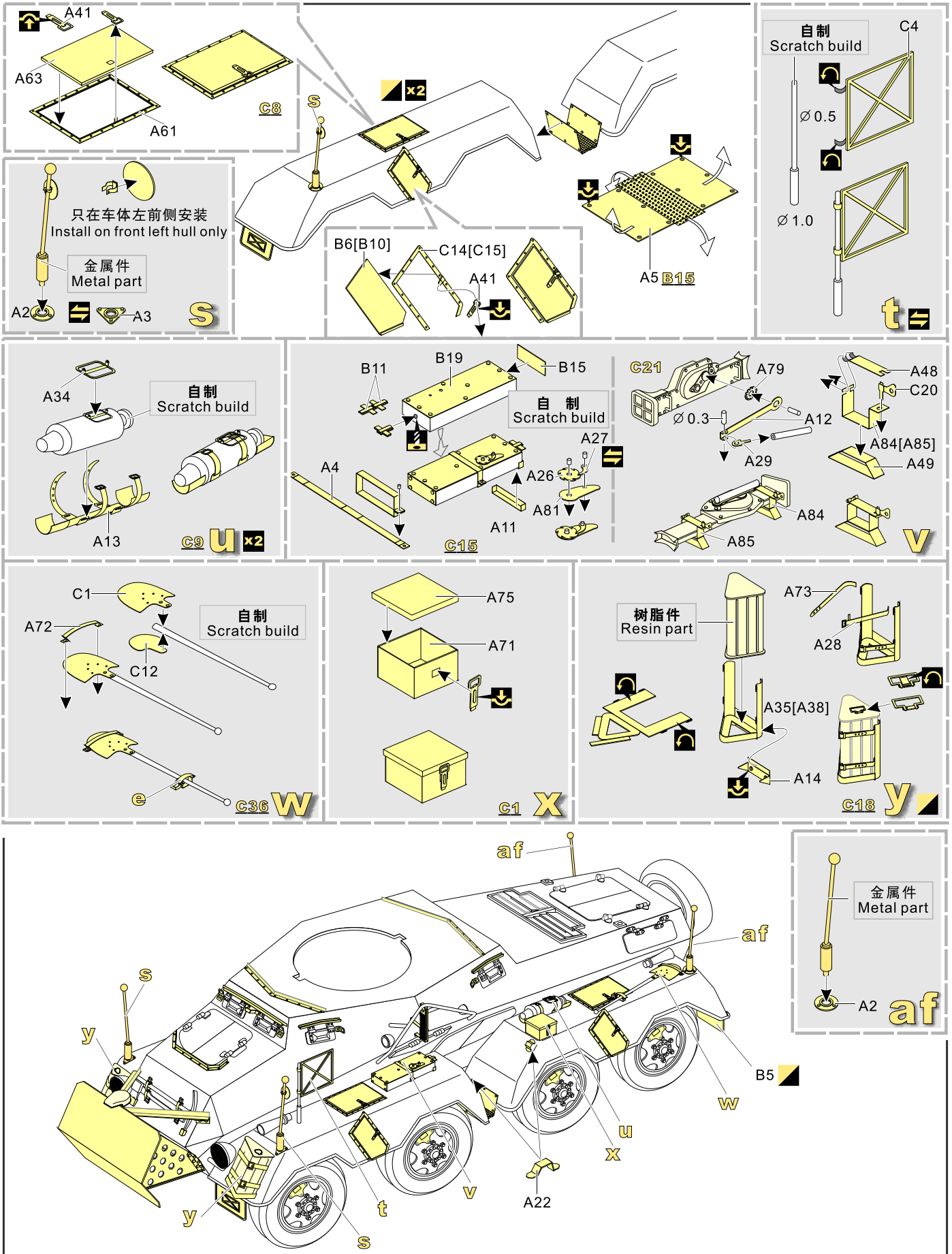

1/35 MILITARY MINIATURE VEHICLE UPGRADE SERIES PE35193

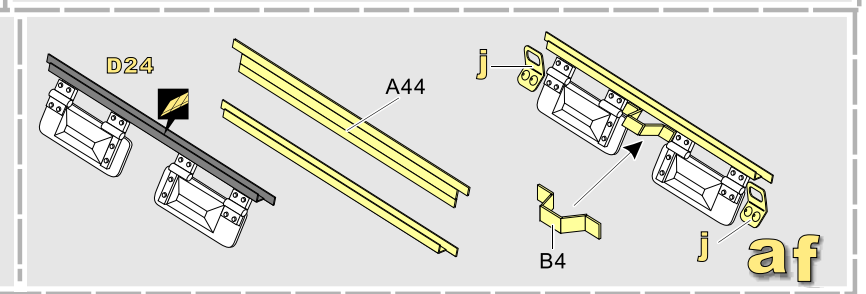
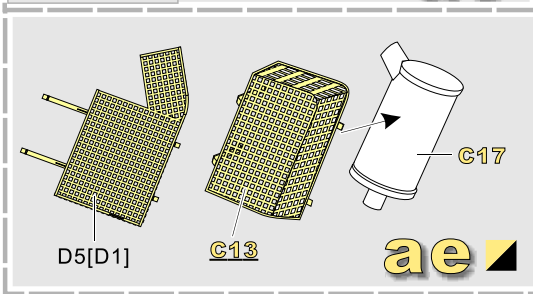
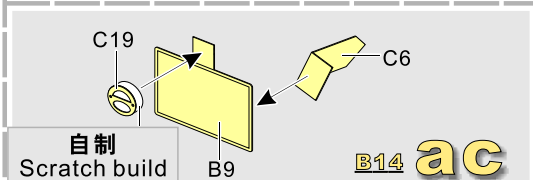
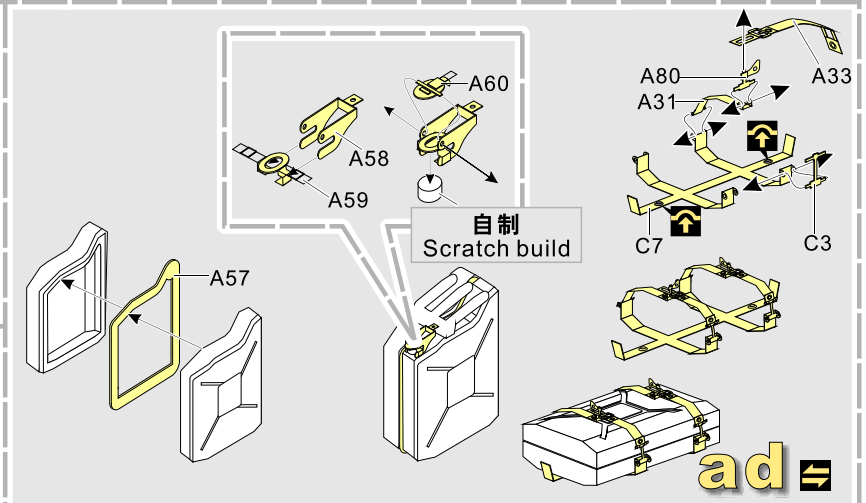
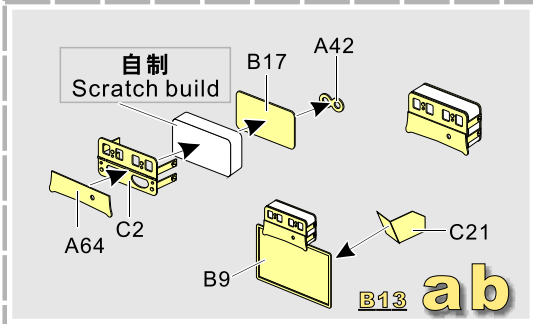
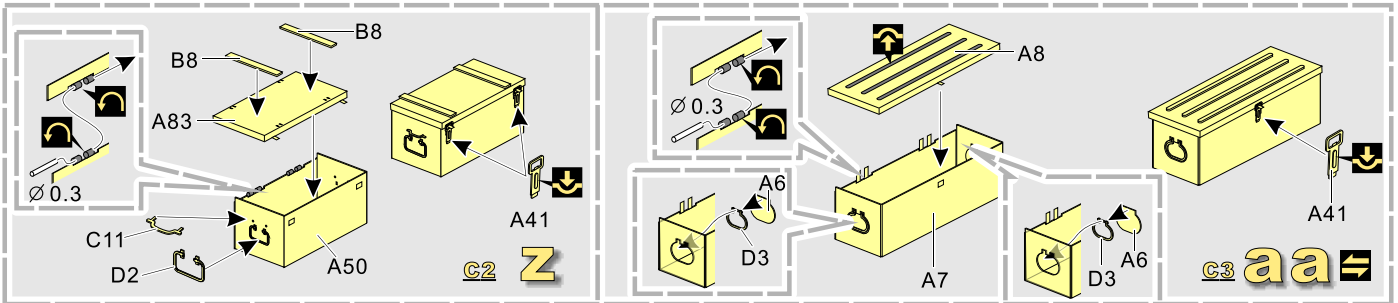

VOYAGERMODEL® 无微不至 极致享受
The Best Upgrade Solution

Recommended item	
Pe35065	WWII German Sd.kfz 232 6 Rad
Pe35204	WWII German Sd.Kfz 222 4Rad
Pe35216	WWII German Sd.Kfz.223
Ap 066	Magazines & Ammo Boxes for KwK 30/38

