

**2 sets**

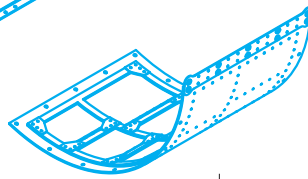

**2 sets**

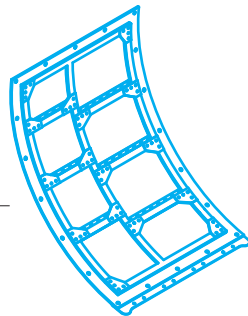
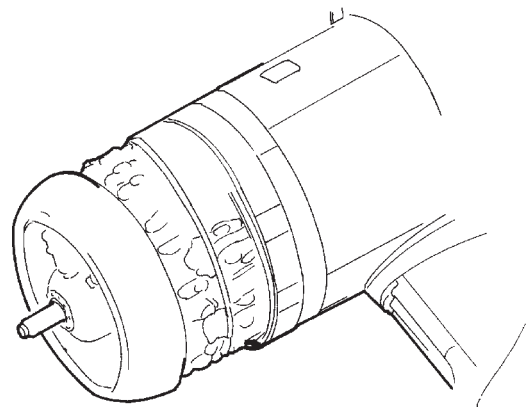
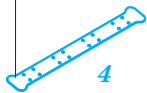
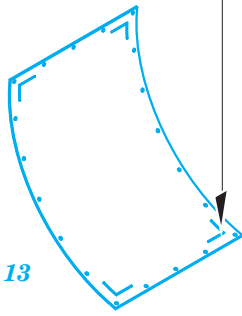
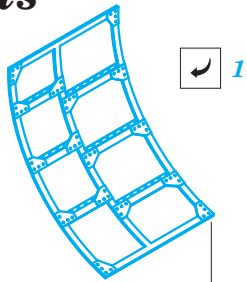
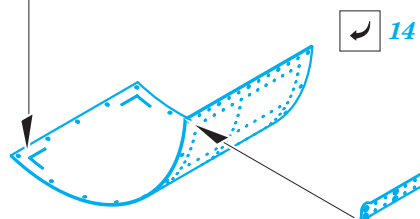

For further detail sets look for **eduard** 32 781 F4U-1 Birdcage interior  
(not included in this set)

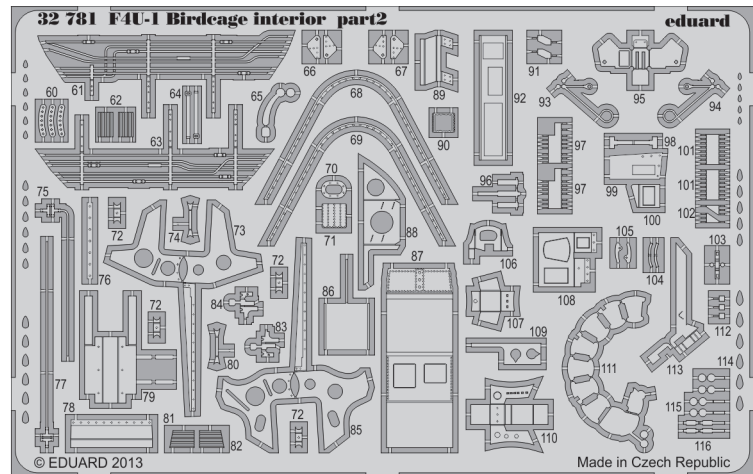
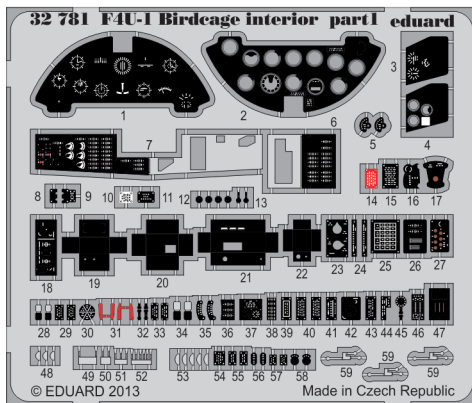

For further detail sets look for **eduard** 32 344 F4U-1 Birdcage exterior  
(not included in this set)

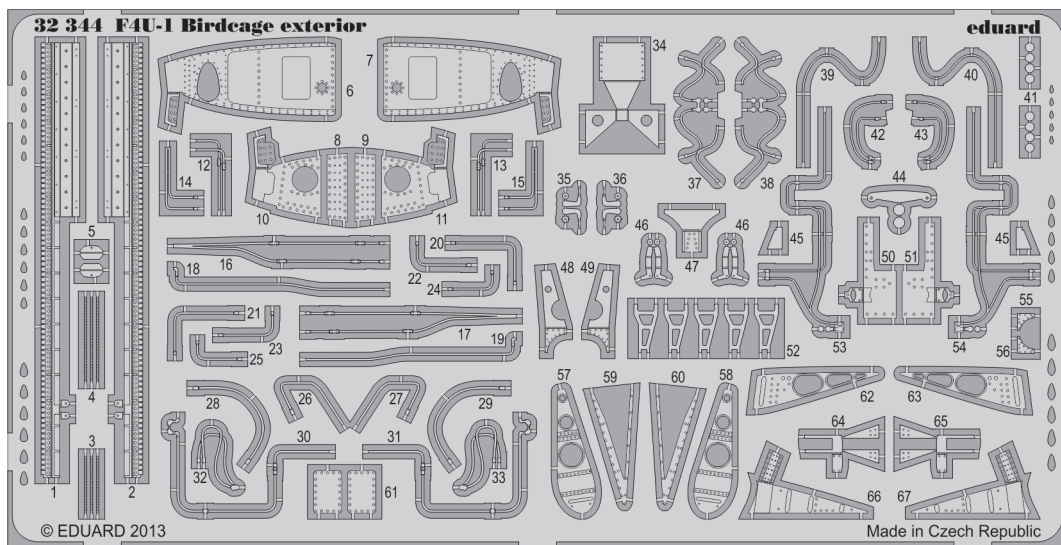

For further detail sets look for **eduard** 32 795 F4U-1 placards  
(not included in this set)

