

# MiG-23BN TFace

**EX 670**

for kit **EDUARD/TRUMPETER**

scale **1/48**

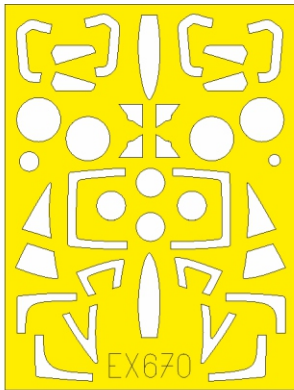

C31 (C36)

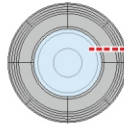

C26 (C41)



C30 (C35)

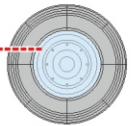

C27 (C42)

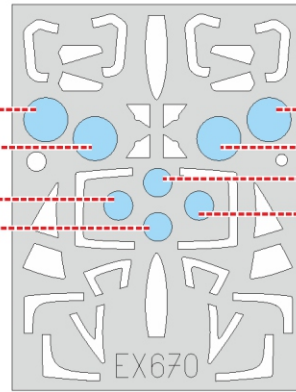

B3, N8

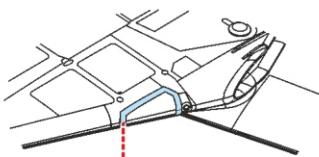

B3, N8

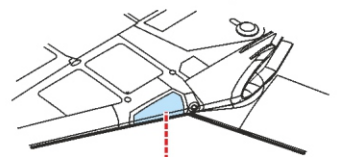

F1

F2

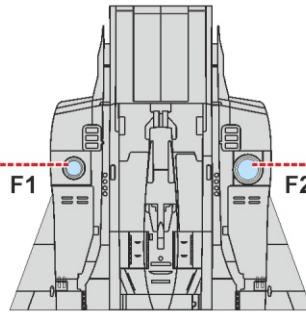

Q2

outside

Q1

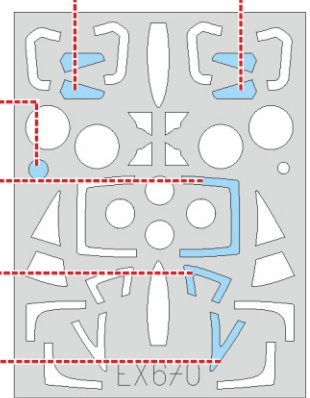
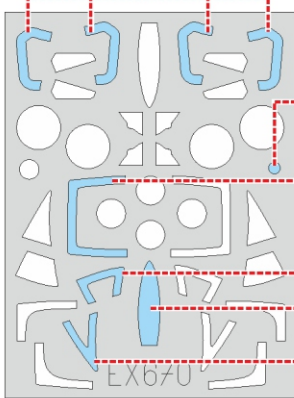

LIQUID MASK ■

M4

M2

inside

Q1

Q2

