

672 136 Spitfire Mk.IX legs BRONZE

w/5 spoke wheels, pattern

For Eduard kit - pro stavebnici Eduard



1/72 scale

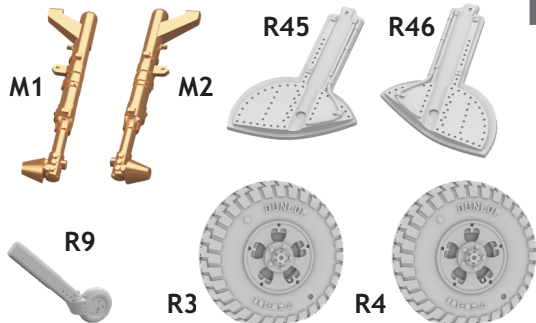

COLOURS

GSI Creos (GUNZE)			Mr. COLOR SUPER METALLIC	
AQUEOUS	Mr.COLOR		SM 06	SUPER CHROME
H 8	C 8	SILVER		
H 77	C137	TIRE BLACK		

This product contains metal and resin detail parts for upgrading scale plastic models. When selecting this set make sure that it is for the kit mentioned in product name as these sets are made specifically for that kit. When upgrading the model some cutting or corrections may be necessary for parts to fit accurately. **WARNING!** This set contains small and sharp parts. Work carefully in a ventilated and well-lit room. Safety glasses are recommended. This product is not suitable for children below 14 years of age.

Tento výrobek obsahuje leptané a odlévané detaily pro úpravu a vylepšení plastického modelu. Při výběru sady kovových detailů zkontrolujte, zda je určena pro model, který chcete upravit. Model, pro který je sada určena, je uveden u názvu výrobku. Pro přesnou aplikaci kovových a odlévaných dílů může být zapotřebí upravit díly upravovaného modelu. **POZOR!** Sada obsahuje malé ostré díly. Pracujte ve větrané a dobře osvětlené místnosti. Doporučujeme použití ochranných brýlí. Tento výrobek není vhodný pro děti mladší 14 let.

eduard

435 21 Obrnice 170
Czech Republic

www.eduard.com



672 136 Spitfire Mk.IX legs BRONZE w/5 spoke wheels, pattern

For Eduard kit - pro stavebnici Eduard

1/72

BRASSIN

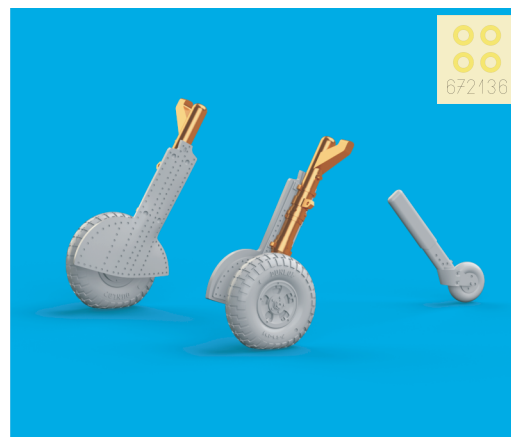

BRASSIN

eduard



BEST BRASS RESIN AROUND!

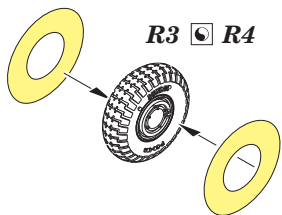

R3 R4

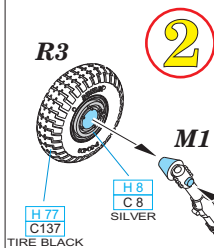

R3

2

M1

H 77
C137
TIRE BLACK

H 8
C 8
SILVER

CORRECT POSITION



FRONT

R3

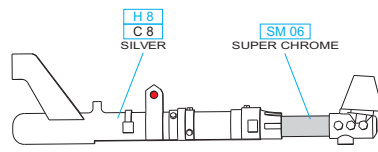

H 8
C 8
SILVER

SM 06
SUPER CHROME

=
ø - 0,3mm

M1 M2

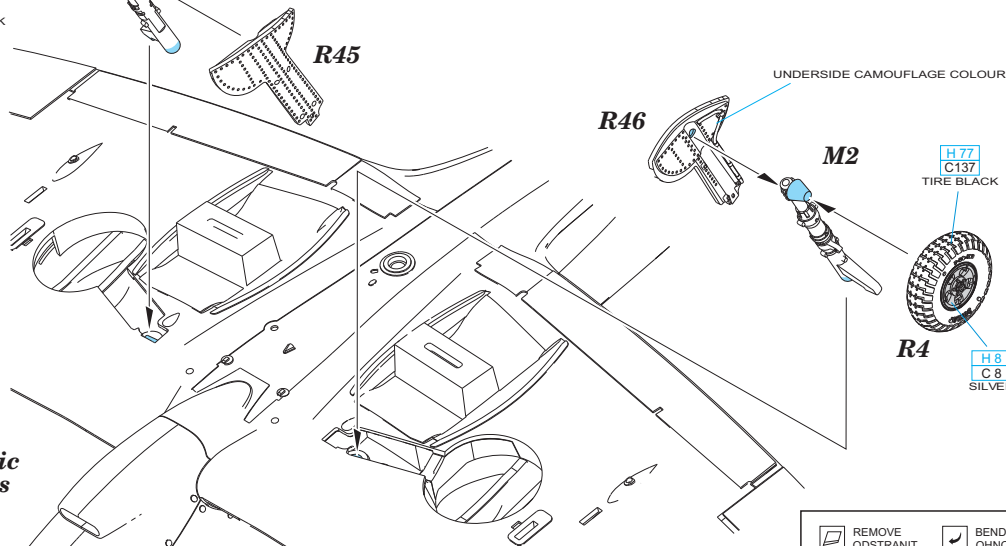

R45

R46

UNDERSIDE CAMOUFLAGE COLOUR

M2

H 77
C137
TIRE BLACK

R4

H 8
C 8
SILVER

plastic parts

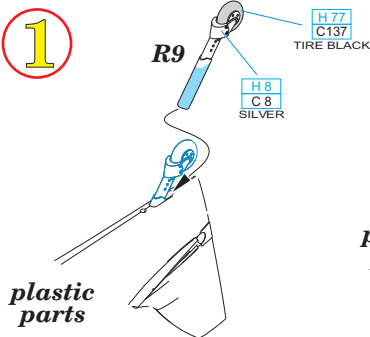

1

R9

H 77
C137
TIRE BLACK

H 8
C 8
SILVER

plastic parts

FRONT VIEW

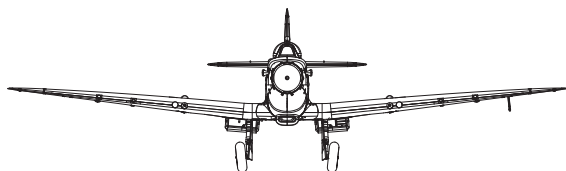

LEFT SIDE VIEW

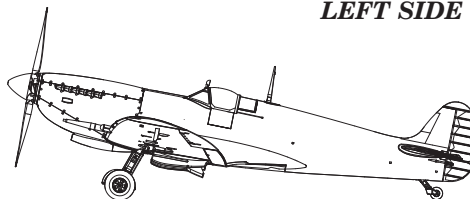

- REMOVE
ODSTRANIT
- BEND
OHNOUT
- GRIND
OBROUSIT
- OPTION
VOLBA
- DRILL HOLE
VRTAT OTVOR
- REPLACE
NAHRADIT
- SYMMETRICAL ASSEMBLY
SYMETRICKÁ MONTÁŽ
- SCRIBE THE PANEL AND HOLES
RYTI
- REVERSE SIDE
OTOČIT