



P-40C landing flaps

eduard

detail set for 1/48 BRONCO FB4006 kit • sada detailů pro stavebnici 1/48 BRONCO FB4006

48 911

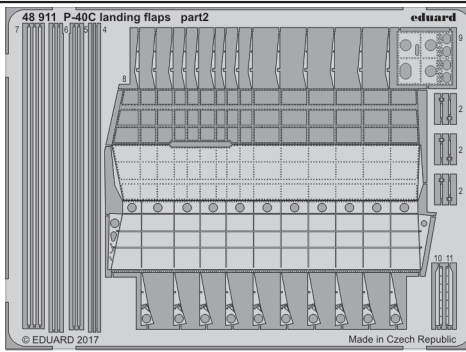
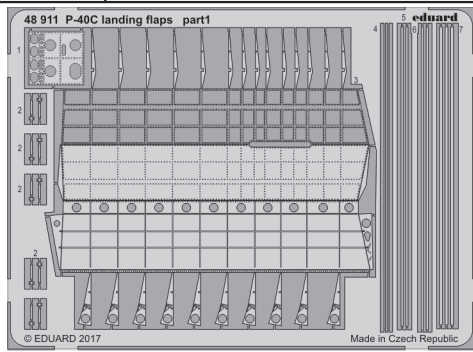

- APPLY EXPRESS MASK AND PAINT BEFORE GLUING
POUŽIT EXPRESS MASK NABARVIT PŘED SLEPENÍM
 - SYMMETRICAL ASSEMBLY
SYMETRICKÁ MONTÁŽ
 - REMOVE
ODSTRANIT
 - GRIND
OBROUSIT
 - DRILL HOLE
VRTAT OTVOR
 - COLORED ETCHED PARTS
LEPTANÉ BAREVNÉ DÍLY
 - ETCHED PARTS
LEPTANÉ NEBAREVNÉ DÍLY
 - ORIGINAL KIT PARTS
PŮVODNÍ DÍLY STAVEBNICE
- BEND
OHNOUT
 - OPTION
VOLBA
 - REPLACE
NAHRADIT

ORIGINAL KIT PARTS
PŮVODNÍ DÍLY STAVEBNICE

PHOTO-ETCHED PARTS
LEPTANÉ DÍLY

PARTS TO BE REMOVED
DÍLY K ODSTRANĚNÍ

FILL
TMELIT

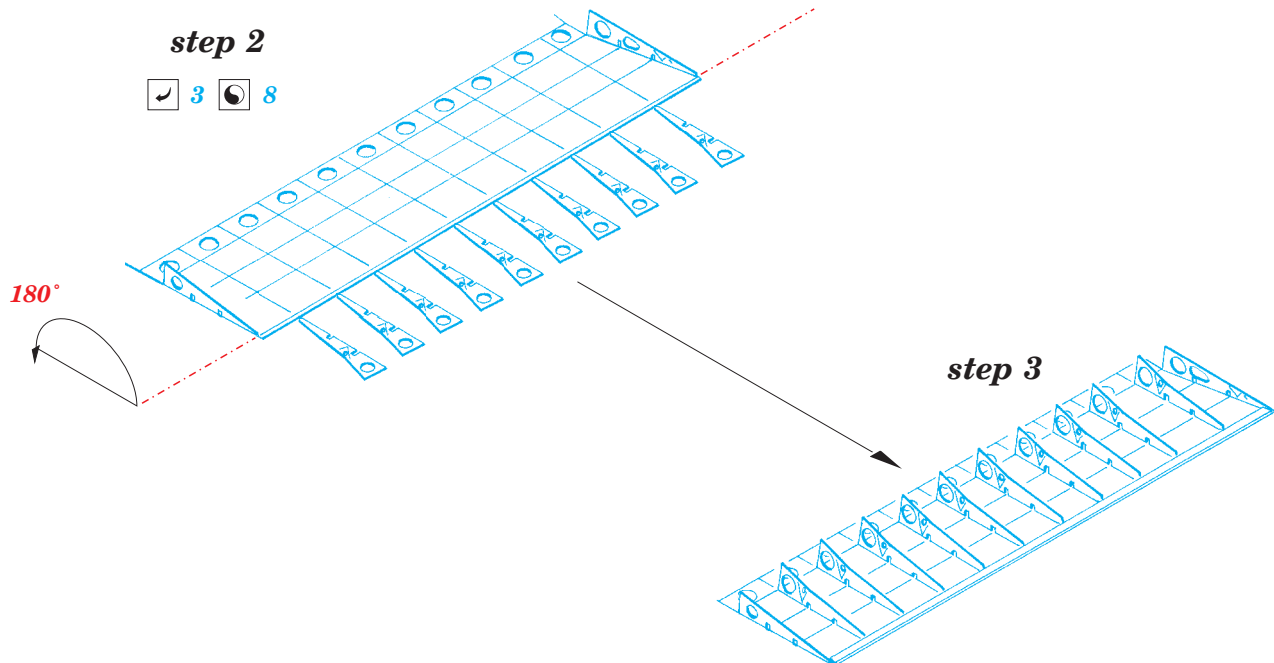
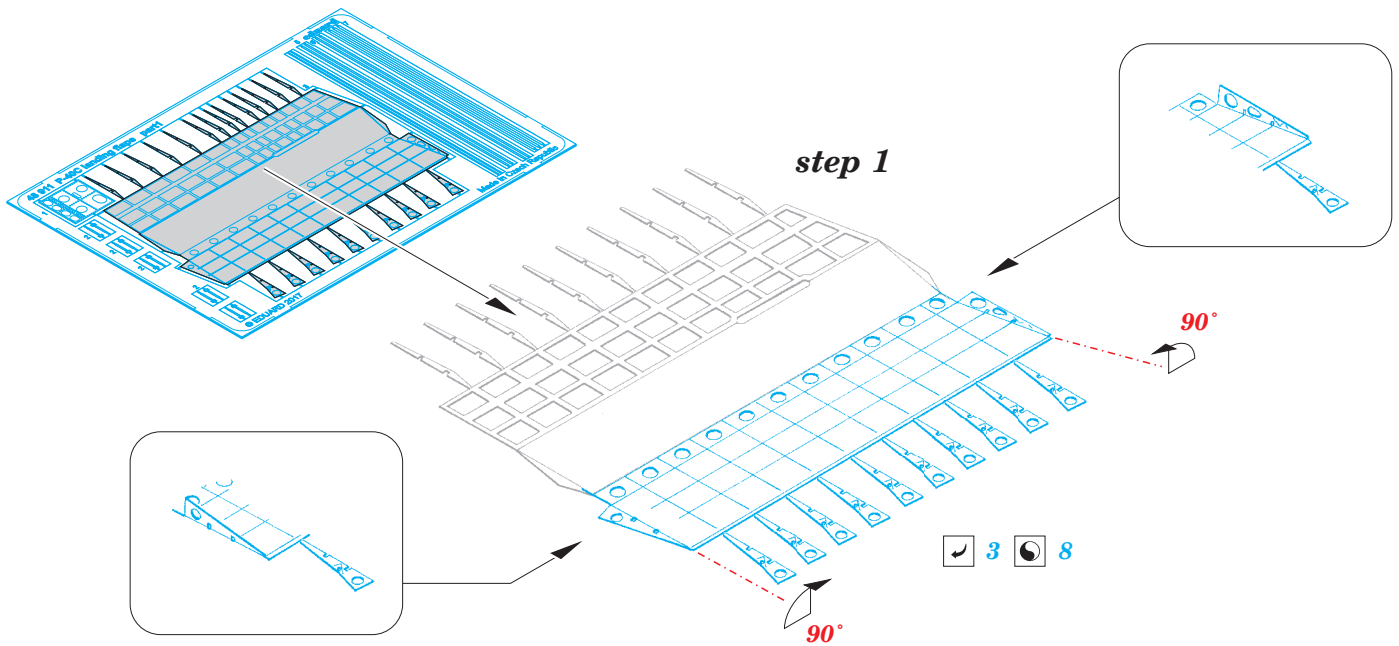

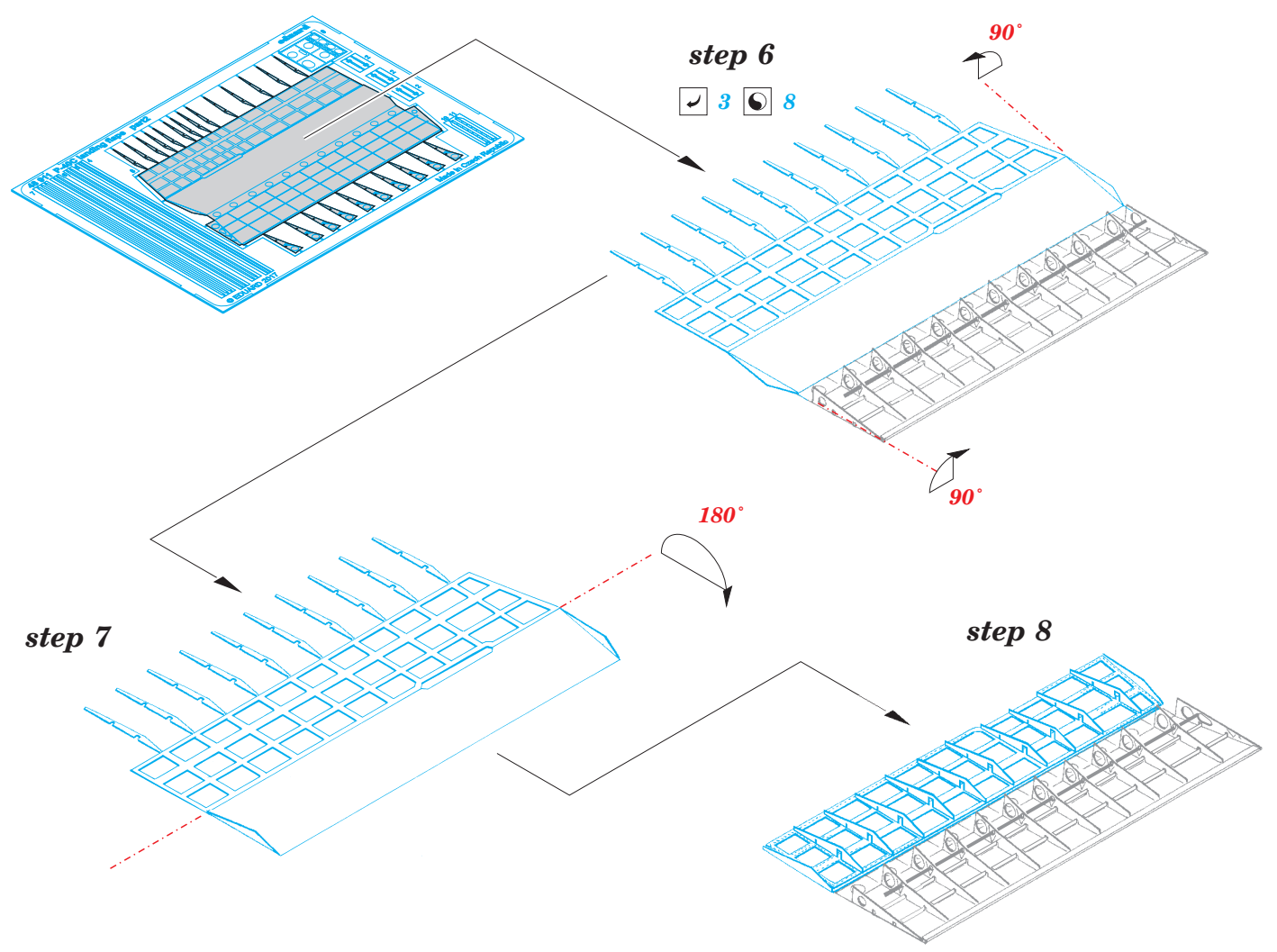
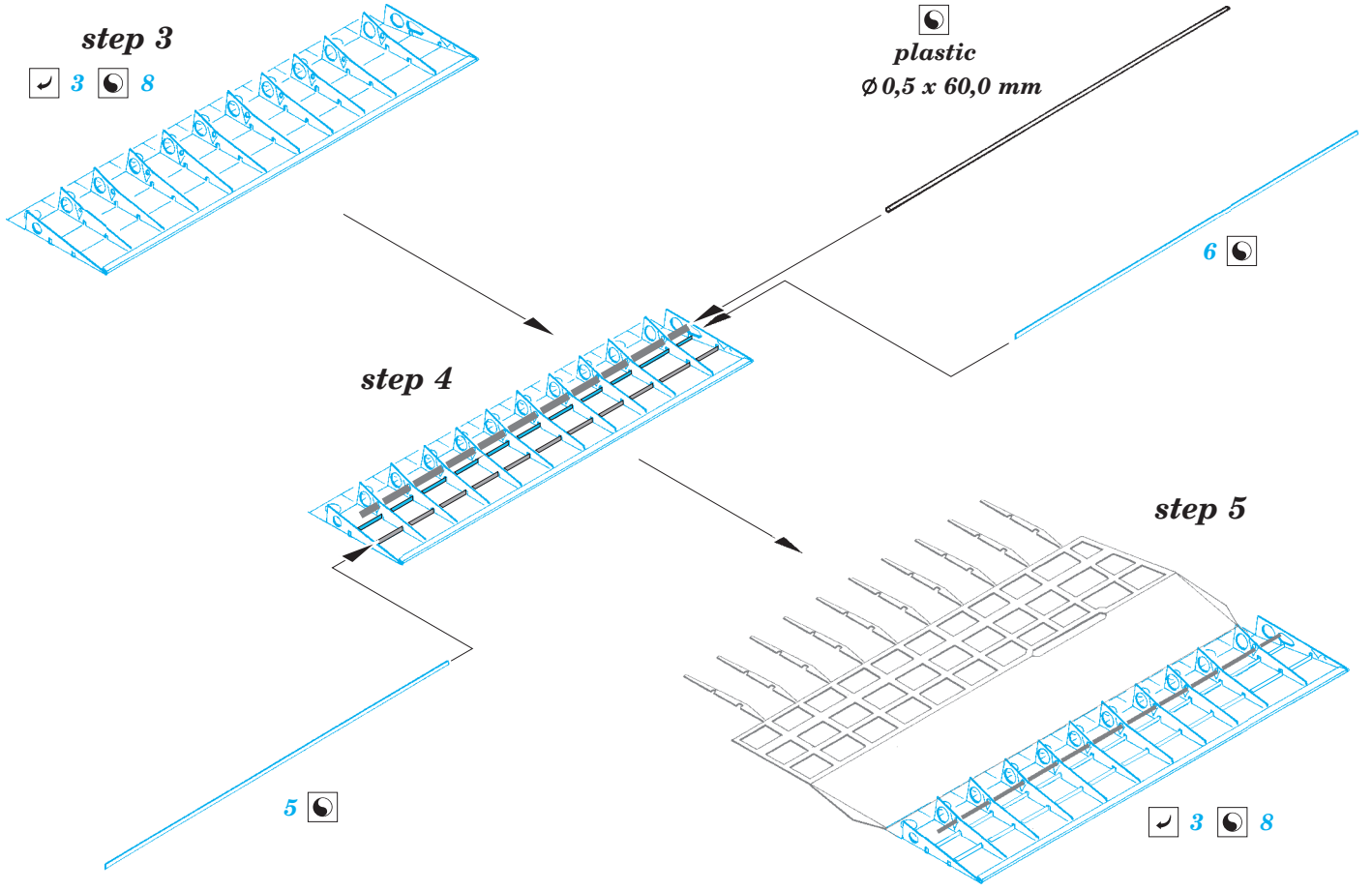

step 8

3 8

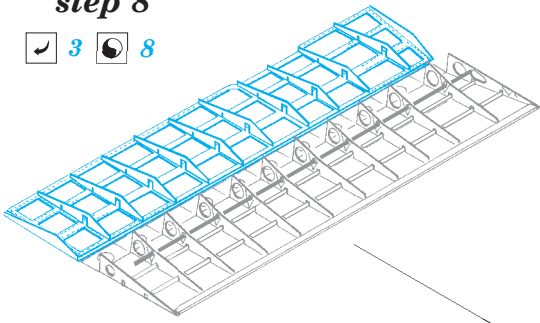

step 9

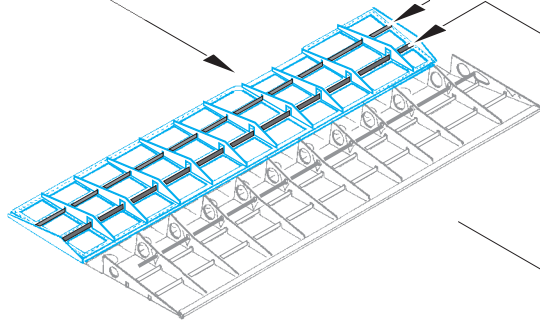

4

7

7

7

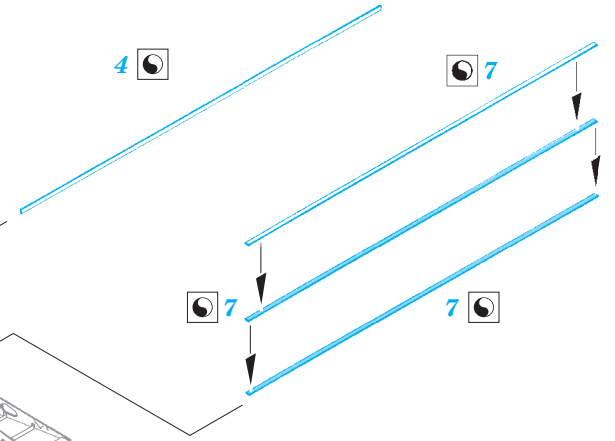

step 10

3 8

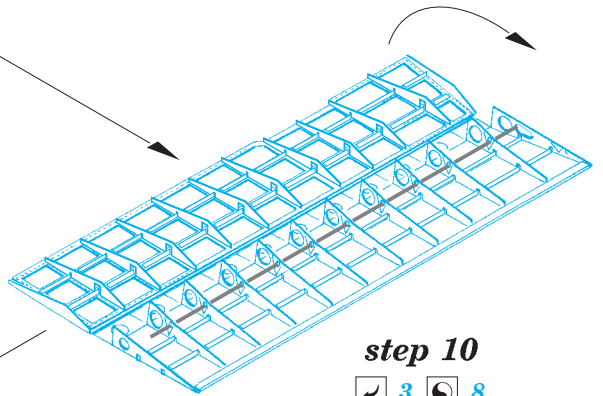

D50 3



D34 8

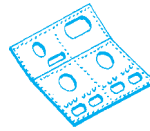
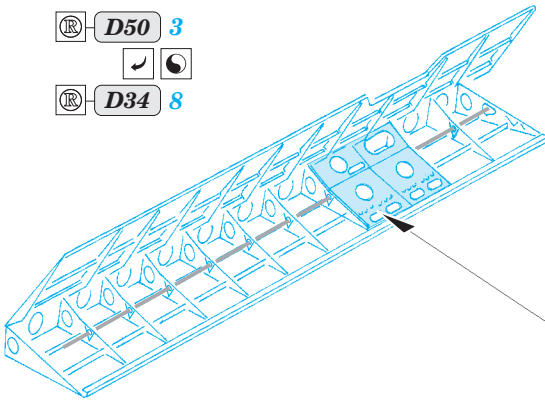

1 D35



9 D36

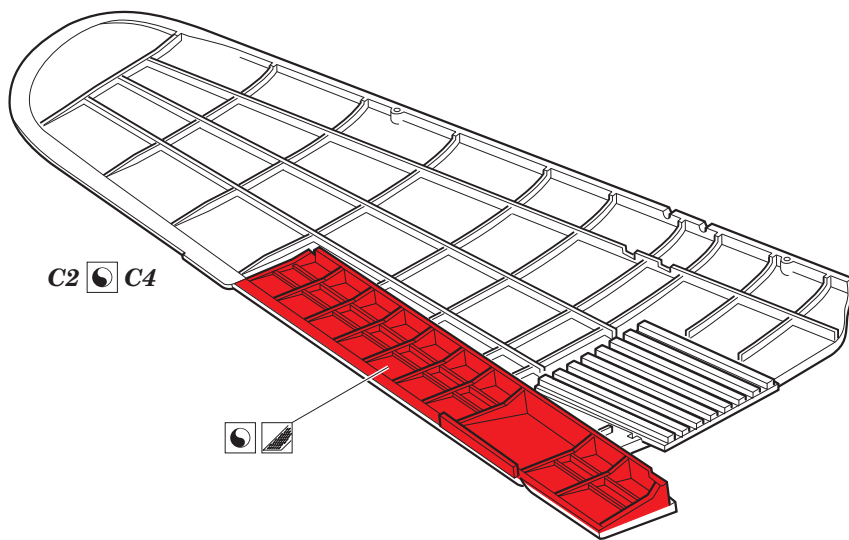

C2 C4



3, 1, 4, 5, 6, 7



8, 9, 4, 5, 6, 7

