

# B-25 Mitchell

The die-cut mask for accurate canopy frame painting of the  
*Acurate Miniatures 1/48 KIT*

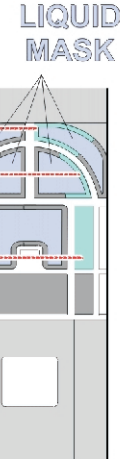

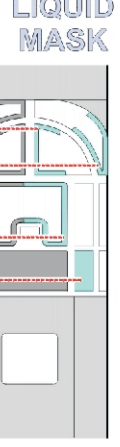
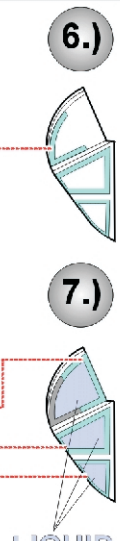
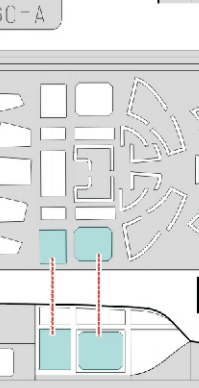
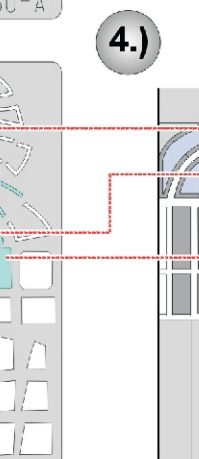
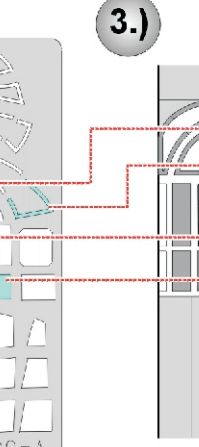
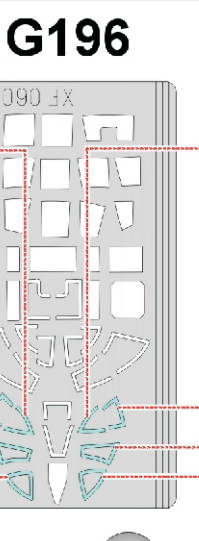
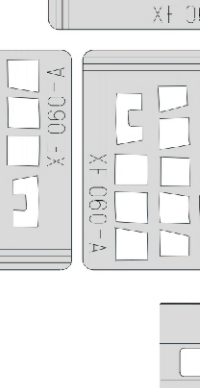
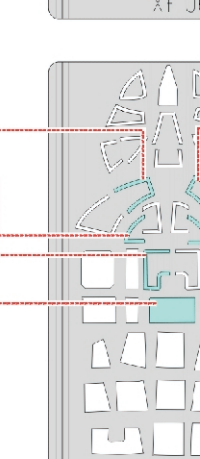
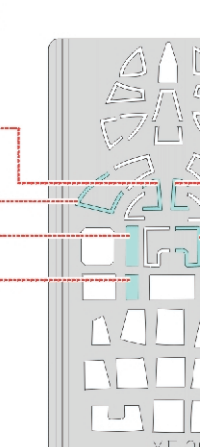
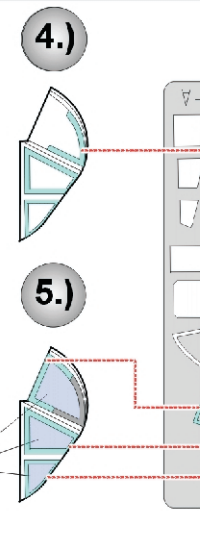
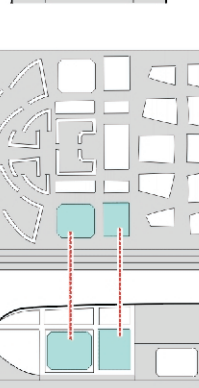
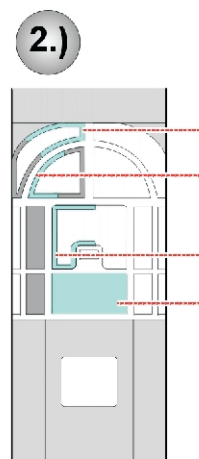
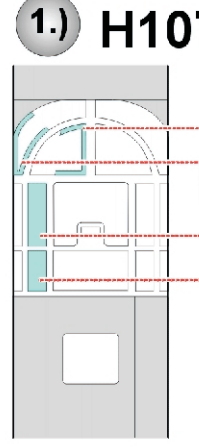
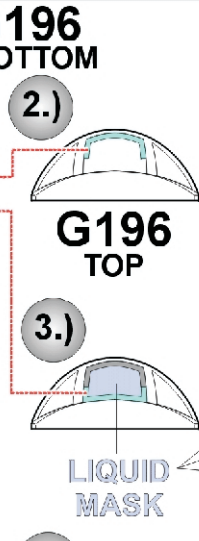
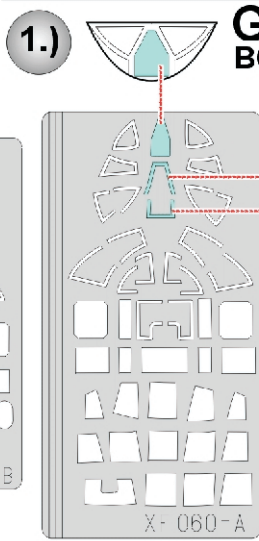
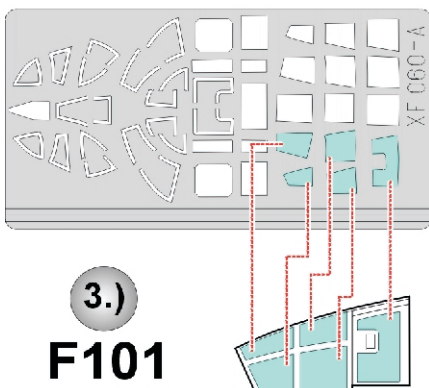
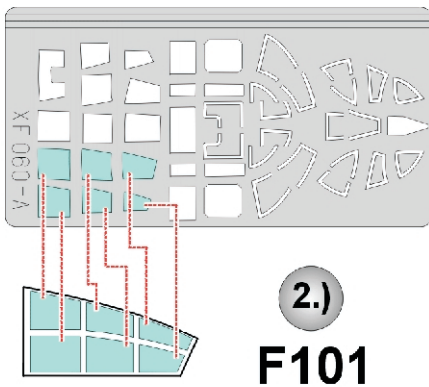
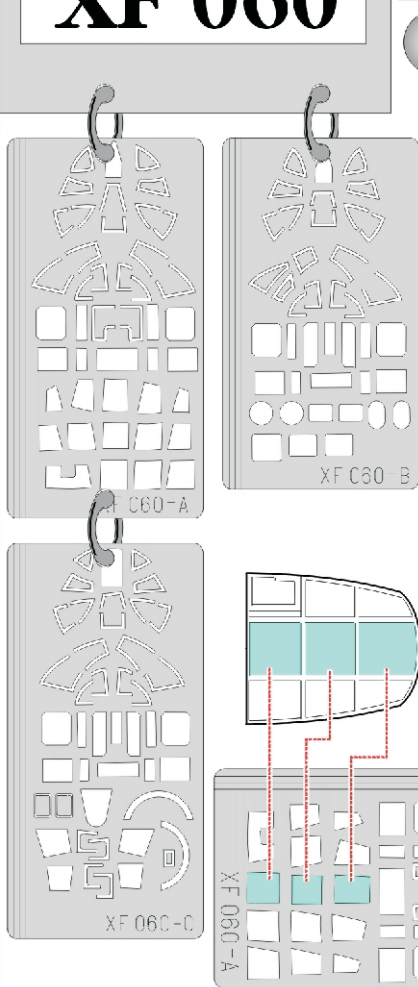
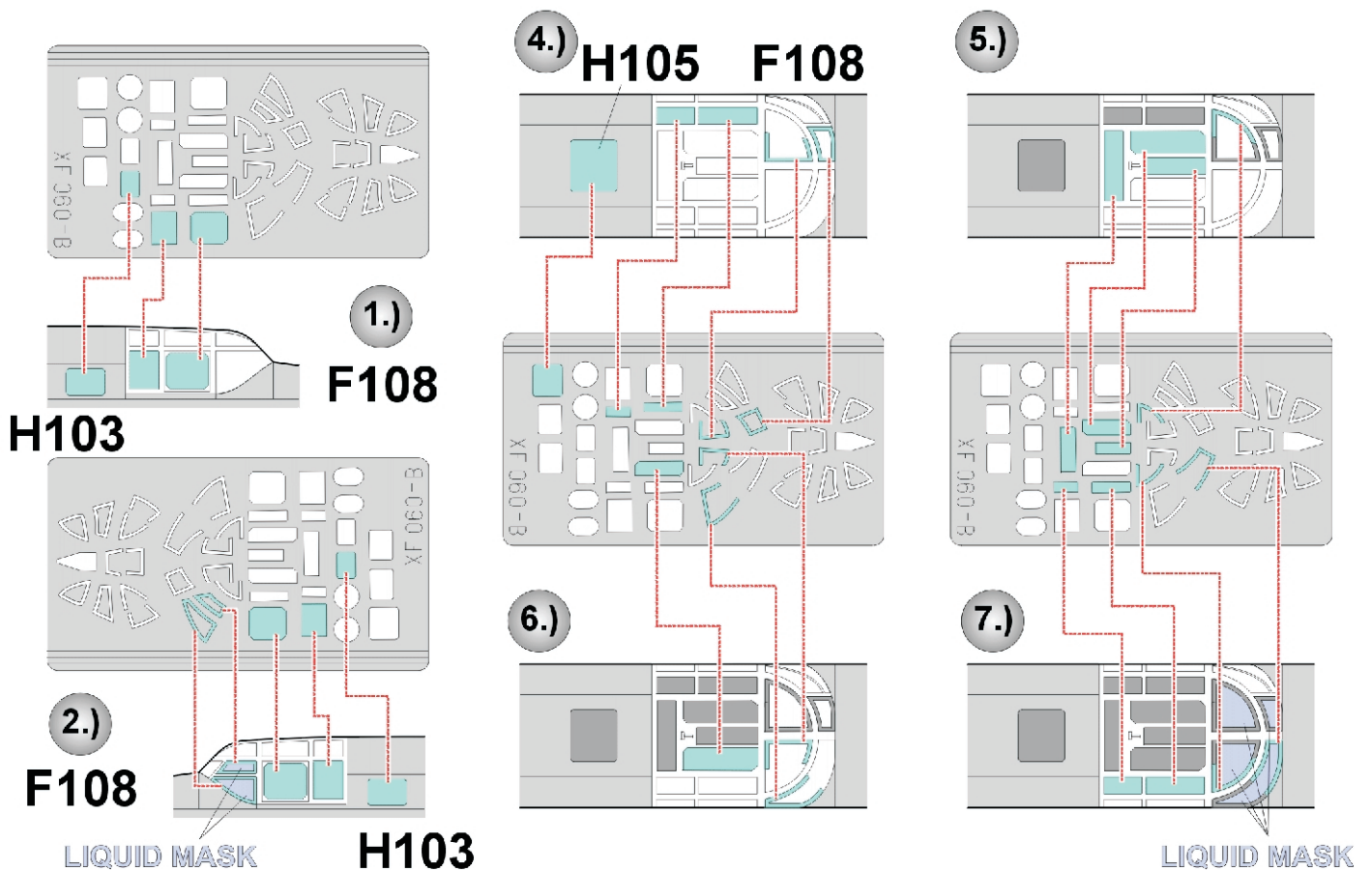
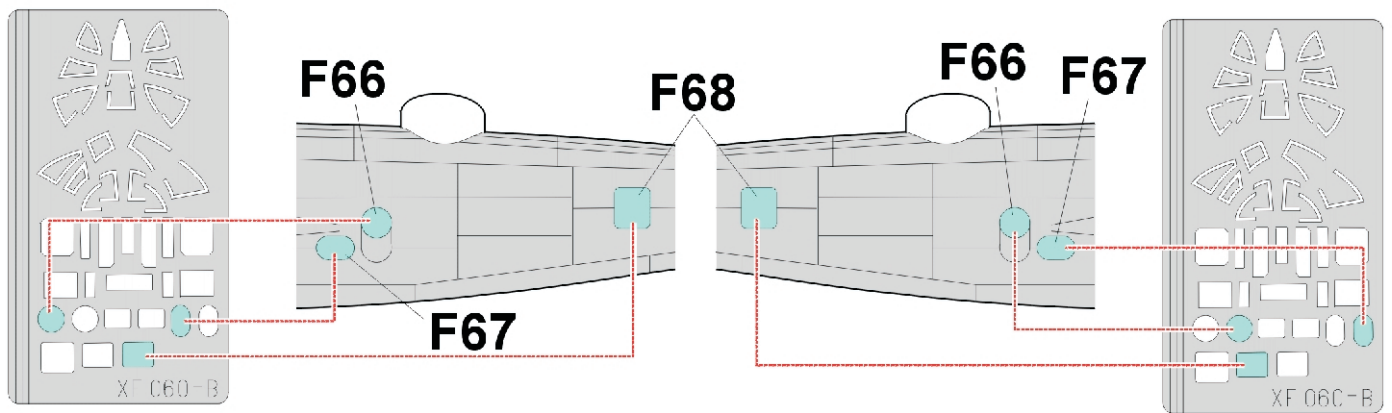
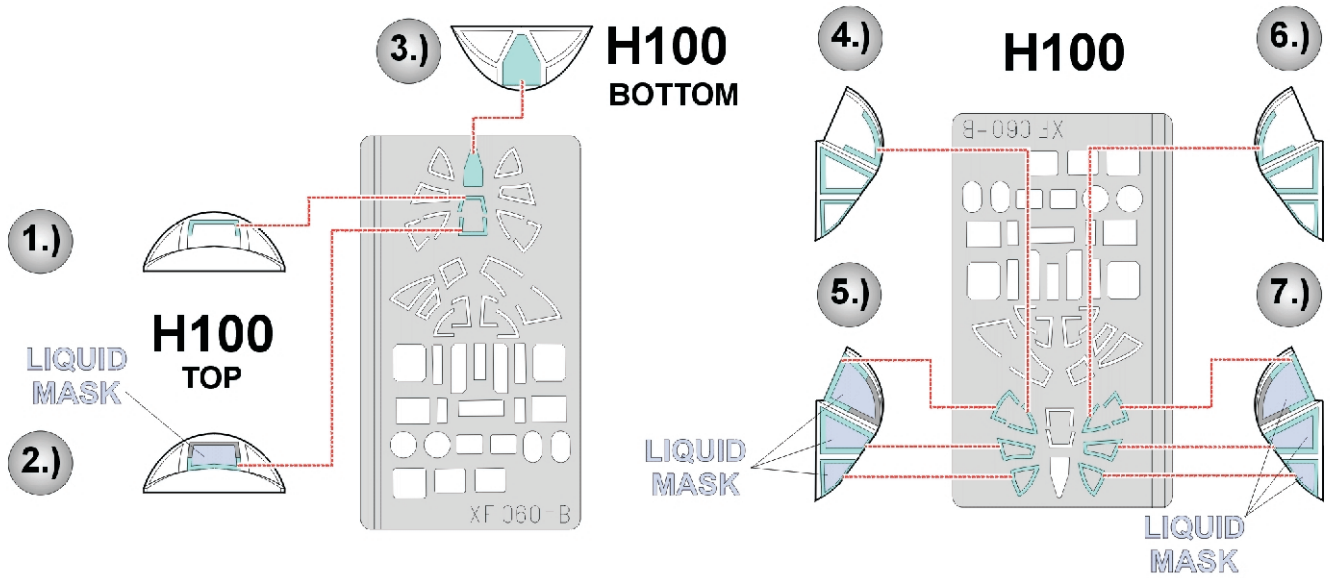

BOTTOM

1.)

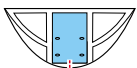

G110

2.)



TOP

3.)

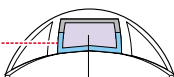

LIQUID MASK

G110

4.)



5.)

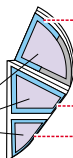

LIQUID MASK

6.)



7.)

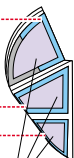

F102

2x  
G129

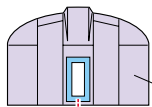

LIQUID MASK

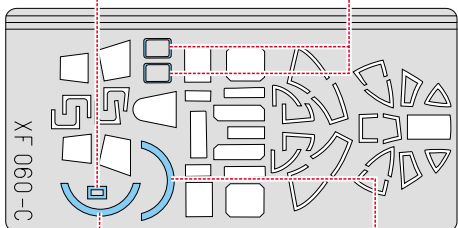
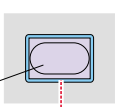

1.)

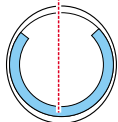

G71

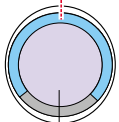

LIQUID MASK

2.)

1.)

G109

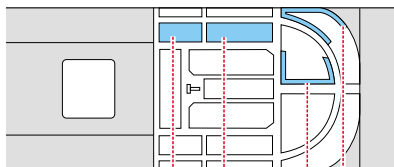

2.)

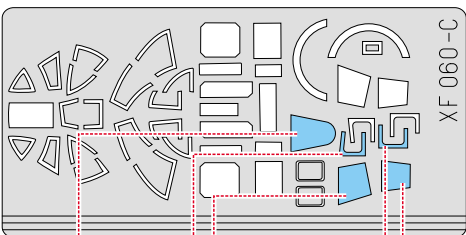
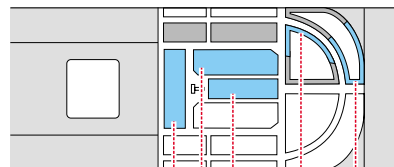

1.)

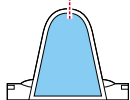

G161

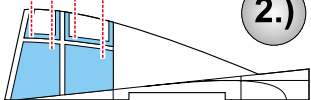

2.)

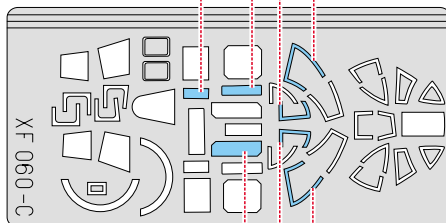

3.)

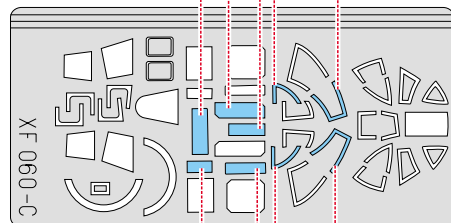
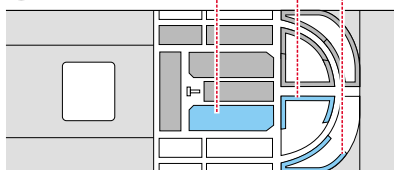

4.)

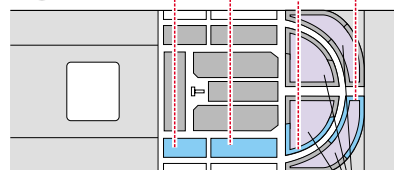

LIQUID MASK

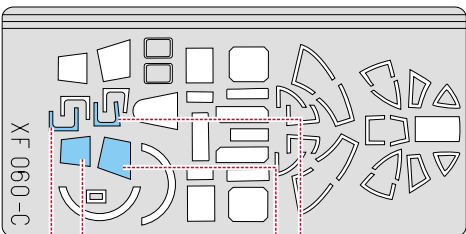

3.)



LIQUID MASK

5.)

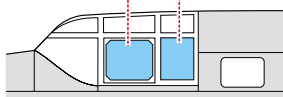

G109

6.)

