

1/35 MILITARY MINIATURE VEHICLE UPGRADE SERIES PE35814

Modern Russian T-14 Armata MBT basic

现代俄罗斯T-14型主战坦克改造基本件

[For TAKOM2029]

推荐使用工具 RECOMMENDED TOOLS

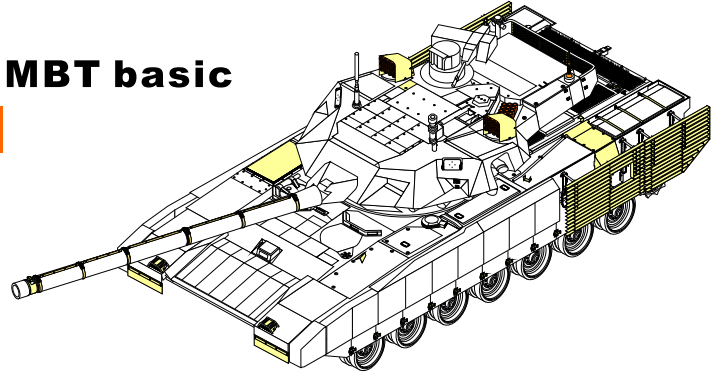
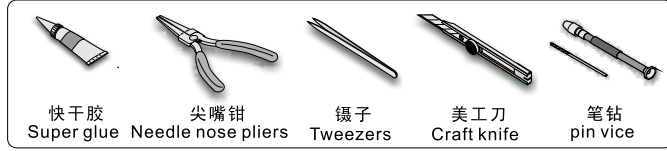

| | | | | | |
|------------------------|---|--|--|---|---------------|
| 安装 install | 折叠 bend | A1 改造件零件编号 PE/resin part number | B12 原零件编号 kit part number | C22 被替换的原零件编号 replaced kit part number | 切除 remove |
| 弧度卷曲 radial bending | x2 制作若干组 multiple assembly | 另一侧相同制作 repeat on opposite side | 选择安装 alternative | 钻孔 drill | 注意 caution |

用尖端在凹槽处冲压
use penpoint to press on the dent

圆珠笔 Ballpen

蚀刻片零件内侧面向上
PE part inboard side turn up

用笔尖在凹槽处刮
Use penpoint scratch on the flute

Ø 0.3

金属材料 Metal part

Front

VOYAGERMODEL

1/35 MILITARY MINIATURE VEHICLE UPGRADE SERIES PE35814

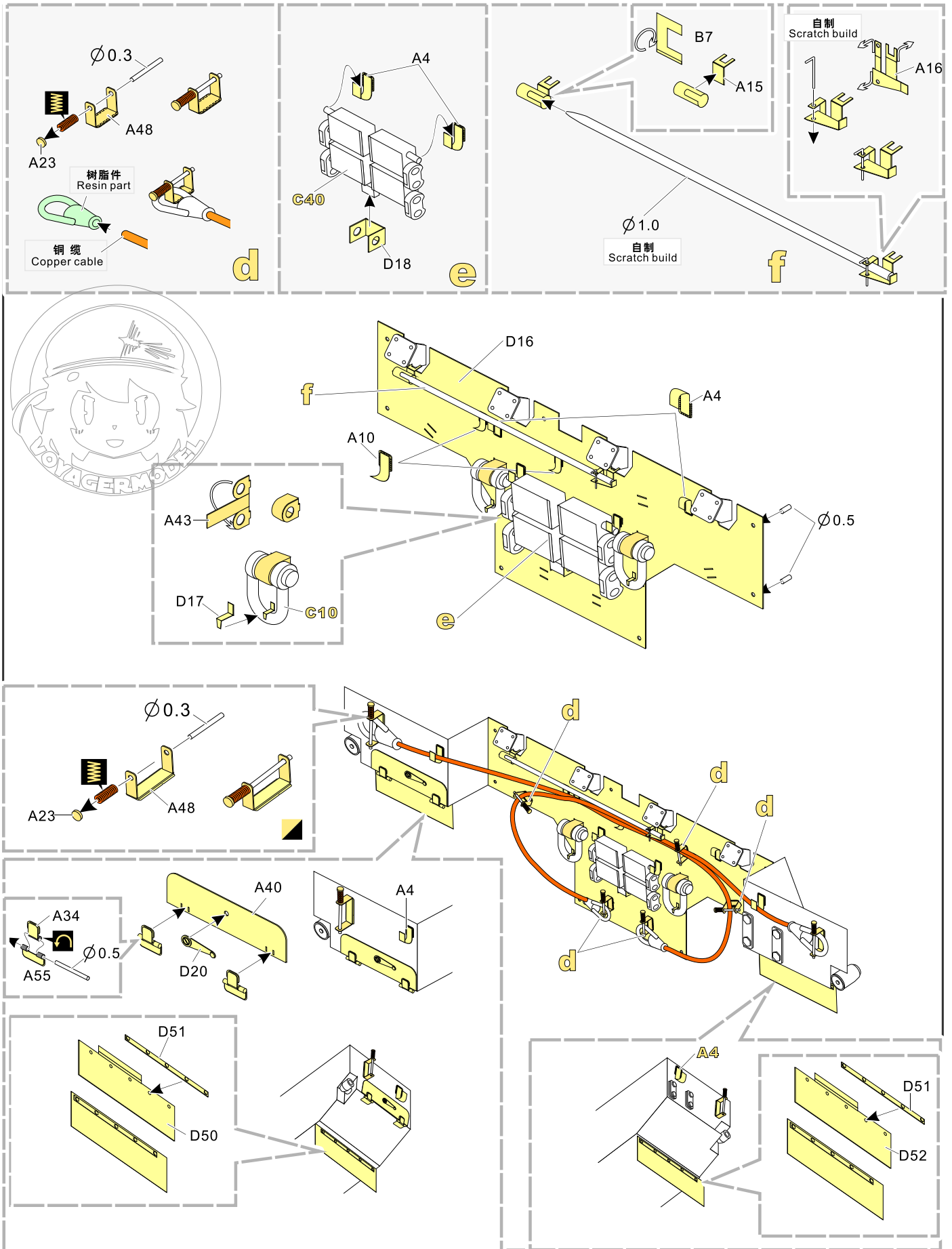

1/35 MILITARY MINIATURE VEHICLE UPGRADE SERIES PE35814

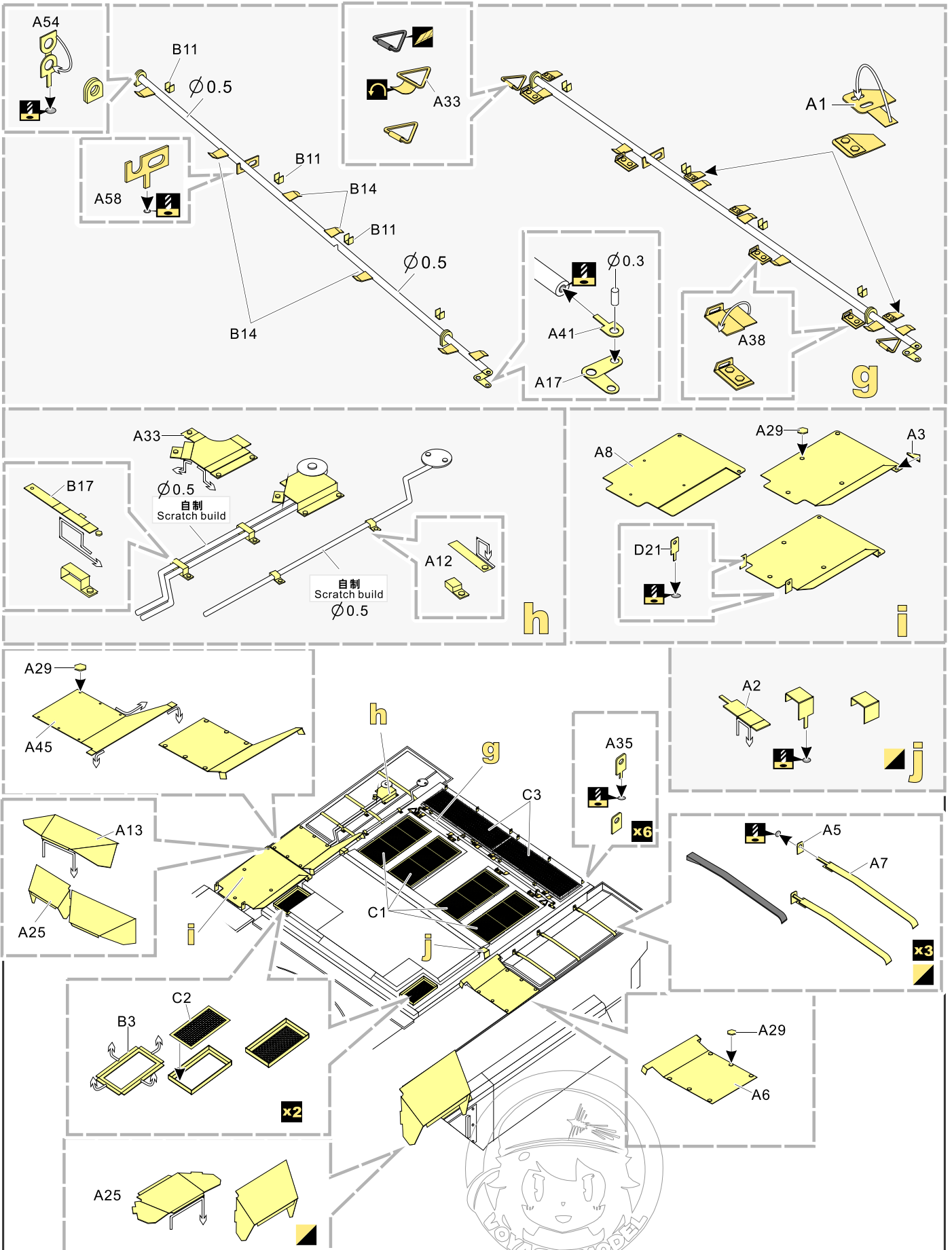

1/35 MILITARY MINIATURE VEHICLE UPGRADE SERIES PE35814

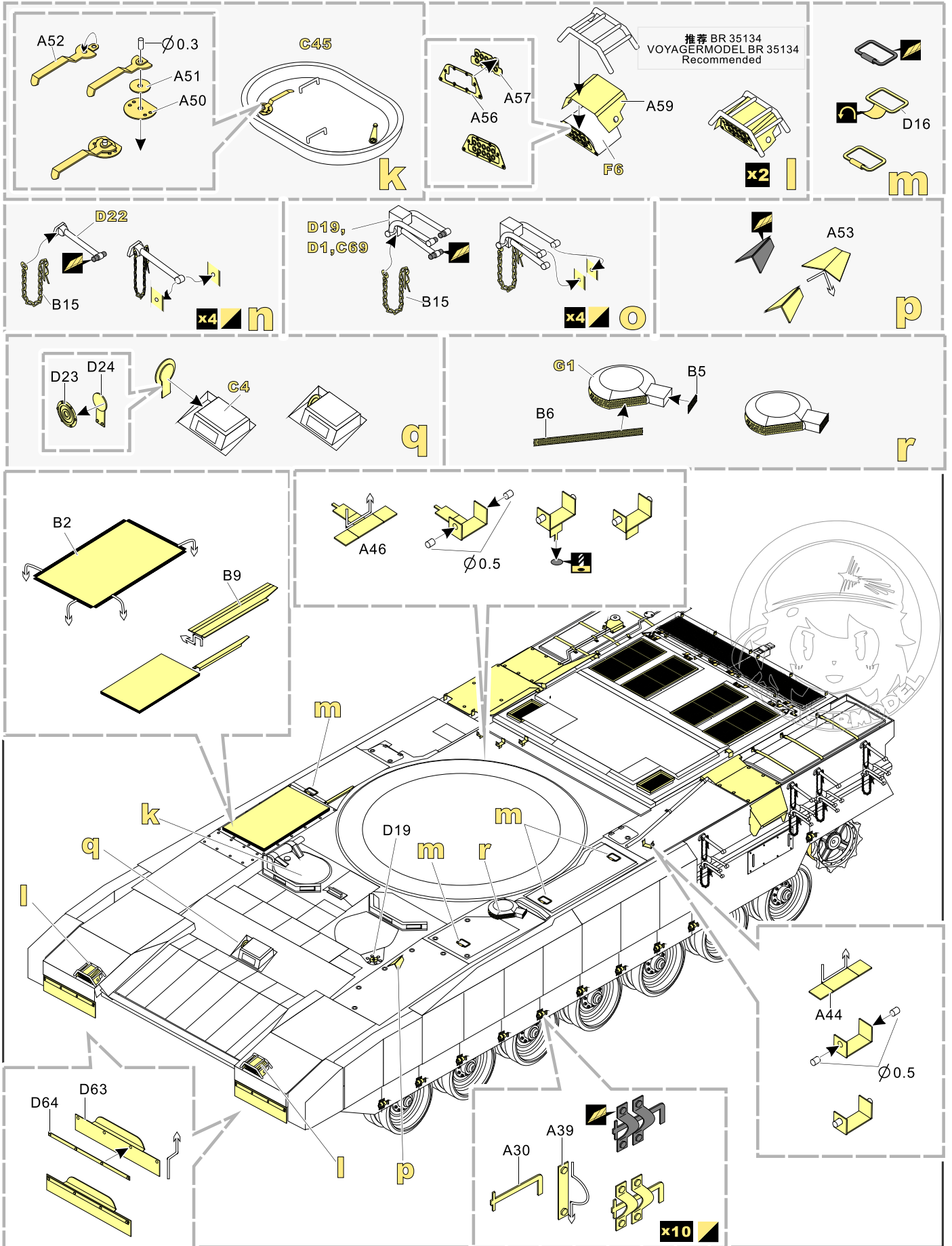

1/35 MILITARY MINIATURE VEHICLE UPGRADE SERIES PE35814

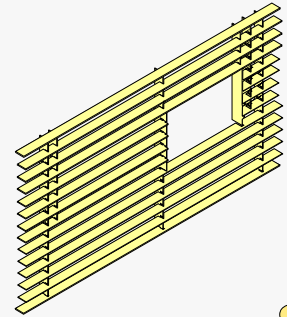
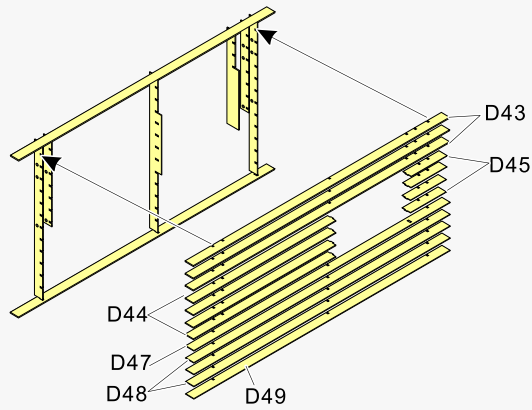
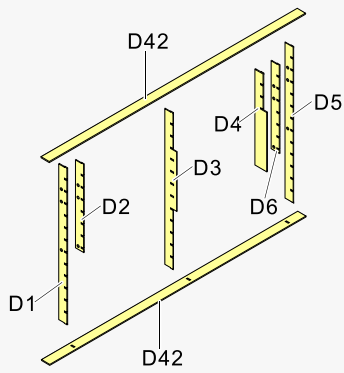

S

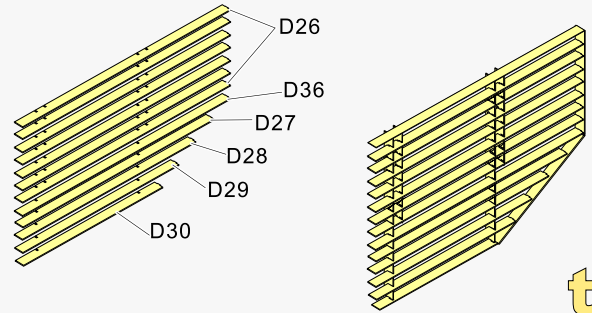
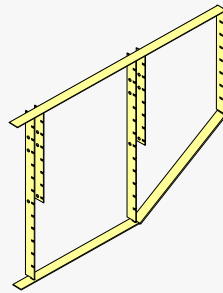
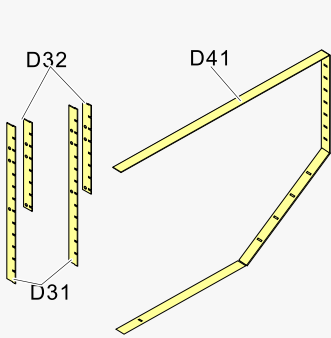

t

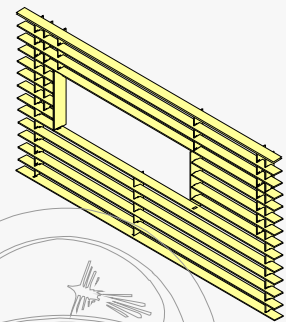
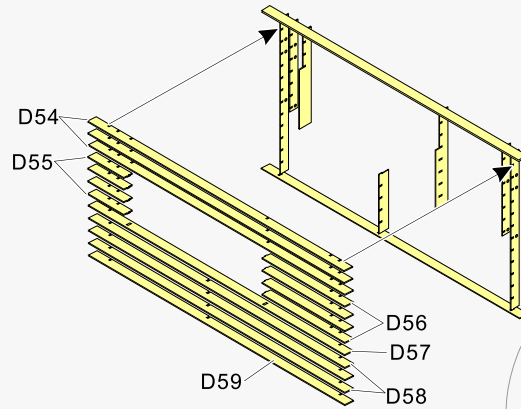
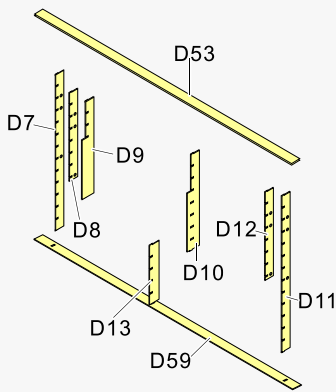

u

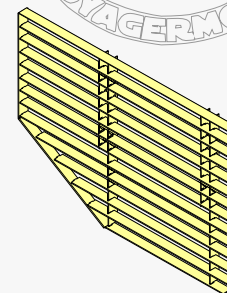
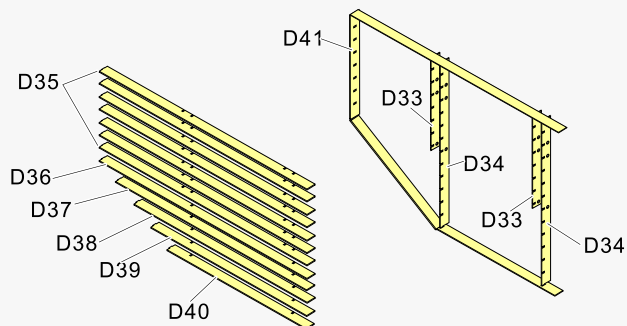

v

1/35 MILITARY MINIATURE VEHICLE UPGRADE SERIES PE35814

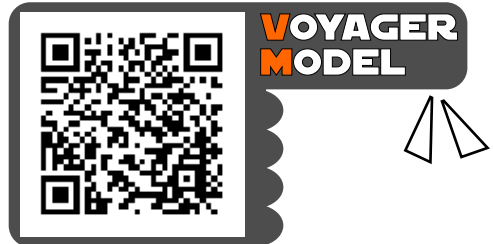
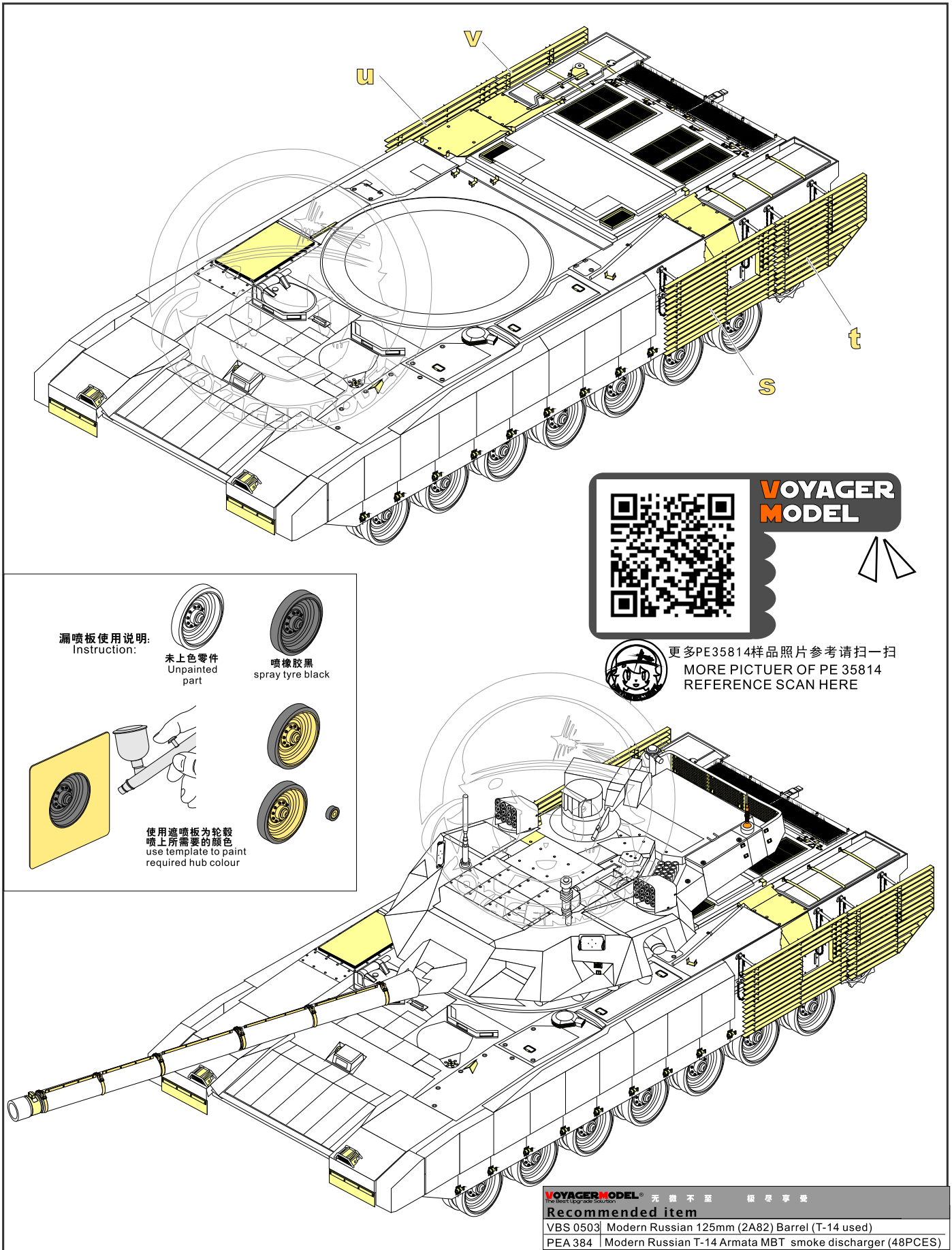

**VOYAGER
MODEL**



漏喷板使用说明:
Instruction:

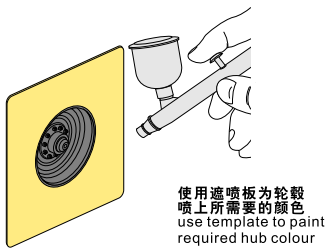

更多PE35814样品照片参考请扫一扫
MORE PICTUER OF PE 35814
REFERENCE SCAN HERE

VOYAGERMODEL[®] 无缝不至 极尽享受

Recommended item

VBS 0503 Modern Russian 125mm (2A82) Barrel (T-14 used)

PEA 384 Modern Russian T-14 Armata MBT smoke discharger (48PCES)