



Marder II

eduard

35 917

1/35 scale detail set for DRAGON kit 6262 • sada detailů pro model 1/35 DRAGON 6262

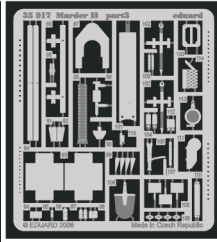
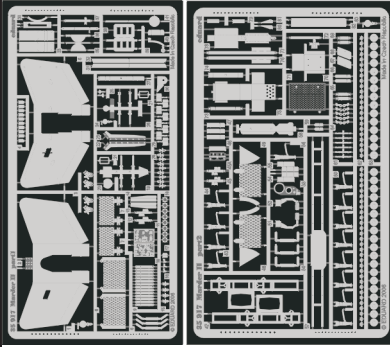

print

35 917
Marder II

- APPLY EXPRESS MASK AND PAINT BEFORE GLUING
POUÍŤ EXPRESNÍ MASKU NABARVIT PŘED SLEPENÍM
- SYMMETRICAL ASSEMBLY
SYMETRICKÁ MONTÁŽ
- REMOVE
ODSTRANIT
- GRIND
OBROUSIT
- DRILL HOLE
VRTAT OTVOR
- BEND
OHNOUT
- OPTION
VOLBA
- REPLACE
NAHRADIT

ORIGINAL KIT PARTS
PŮVODNÍ DÍLY STAVEBNICE

PHOTO-ETCHED PARTS
LEPTANÉ DÍLY

PARTS TO BE REMOVED
DÍLY K ODSTRANĚNÍ

FILL
TMELIT

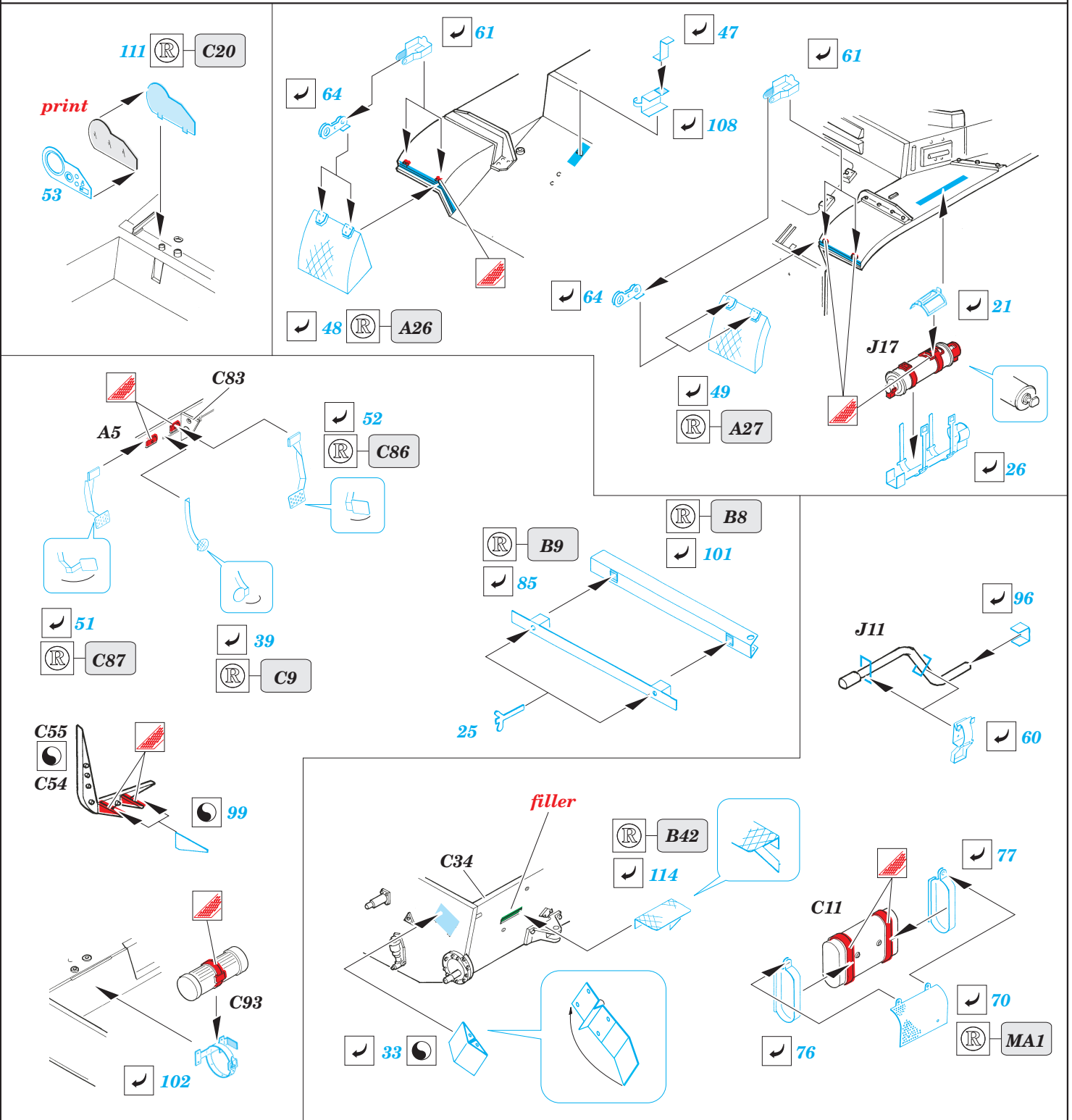

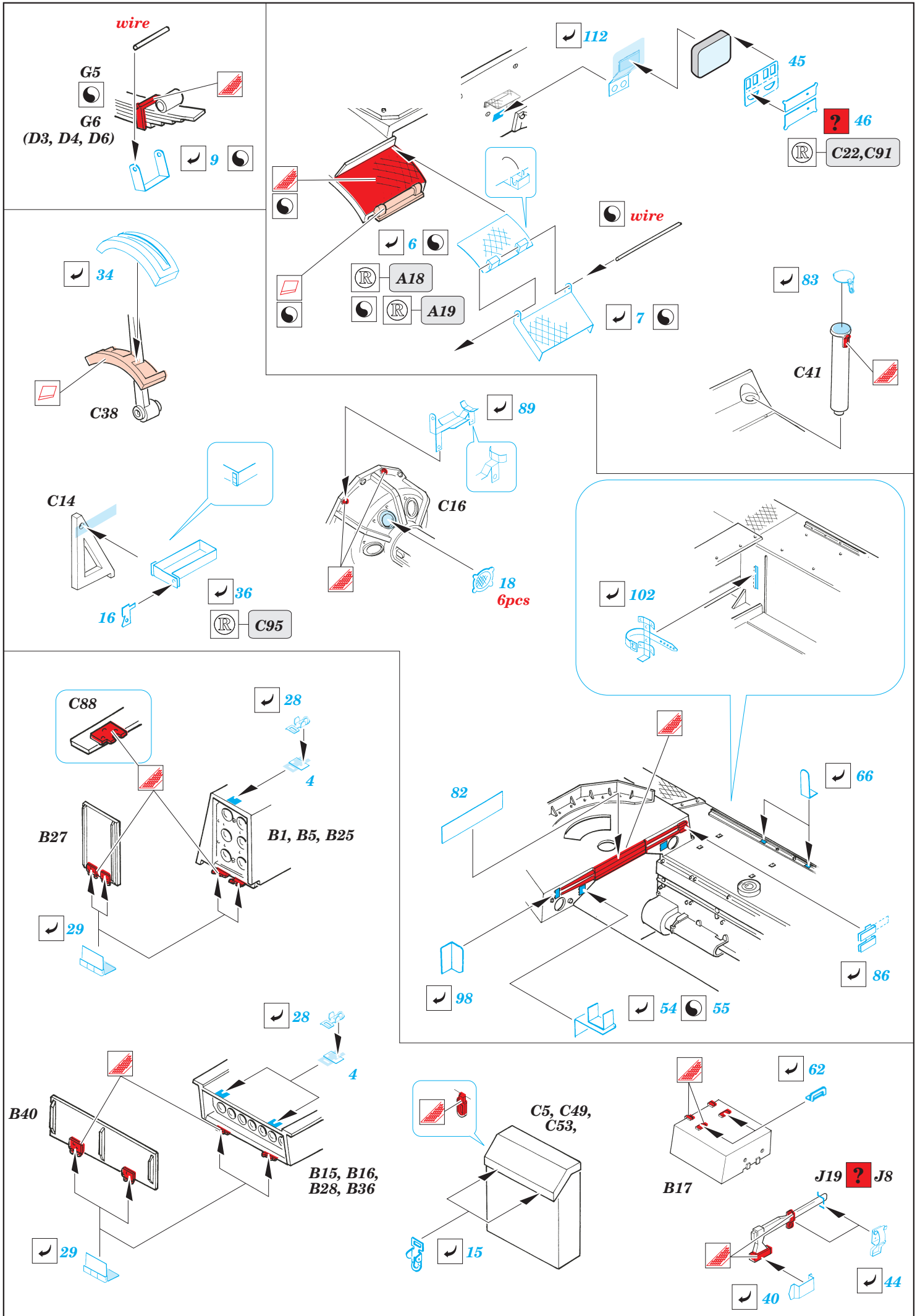

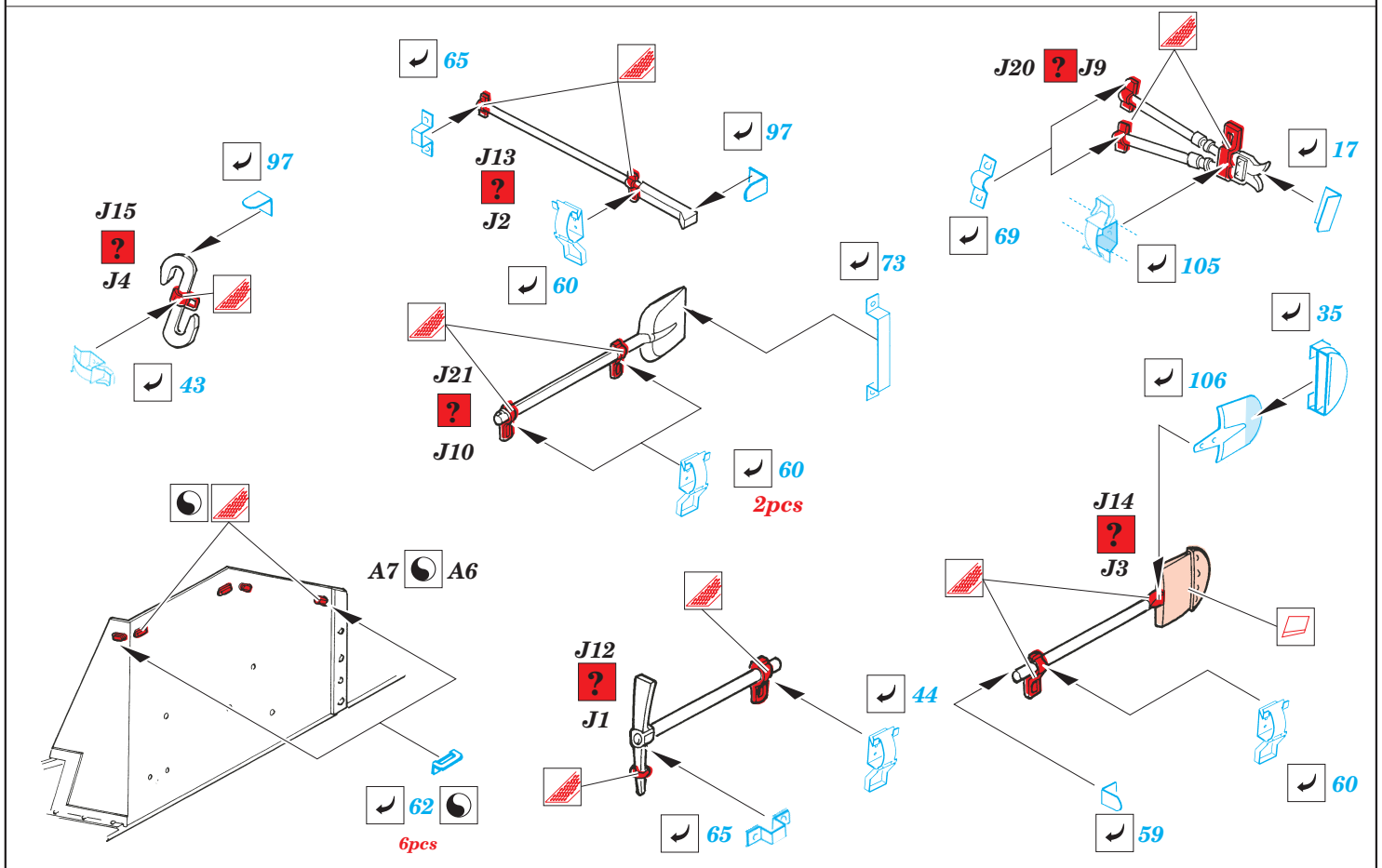
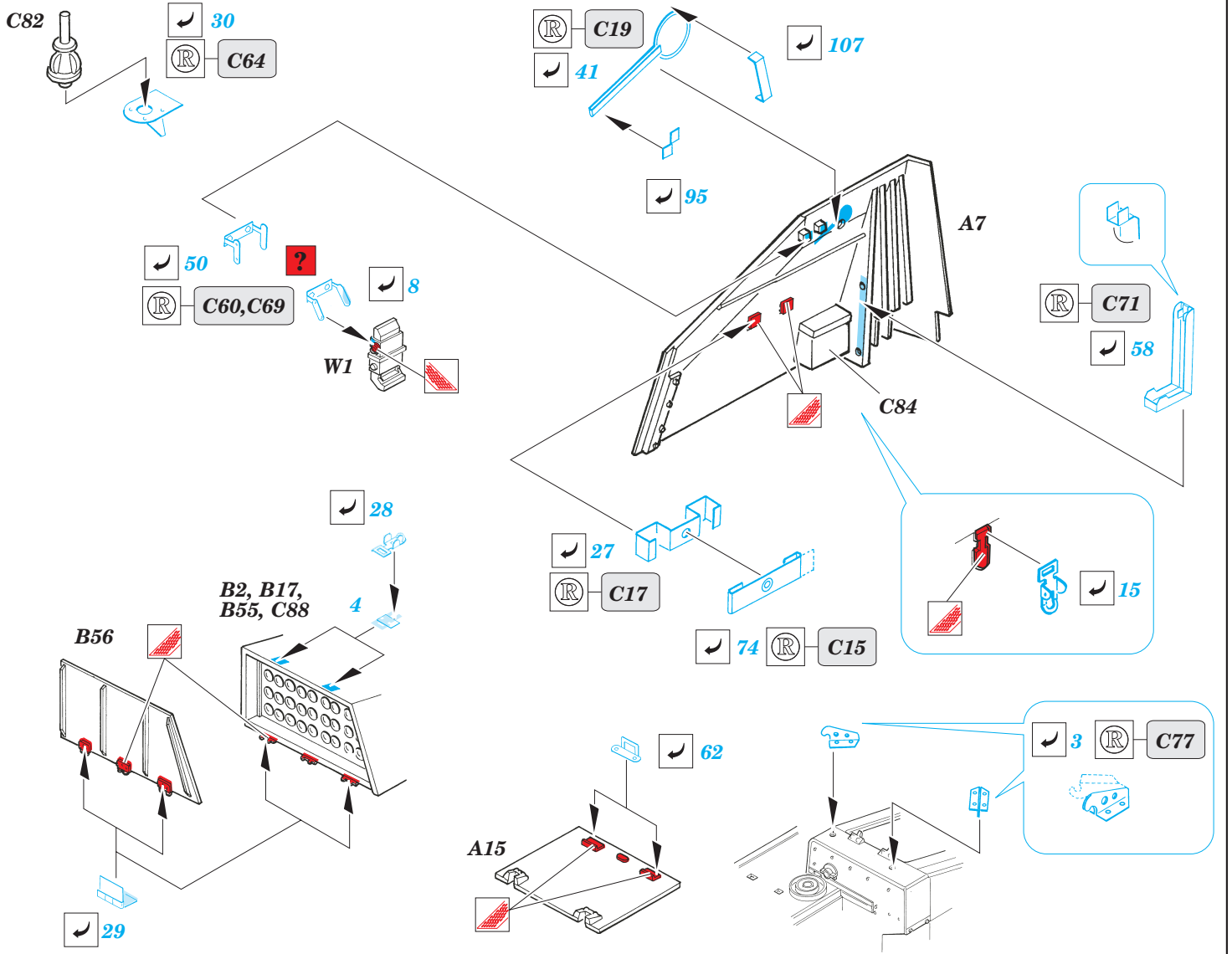

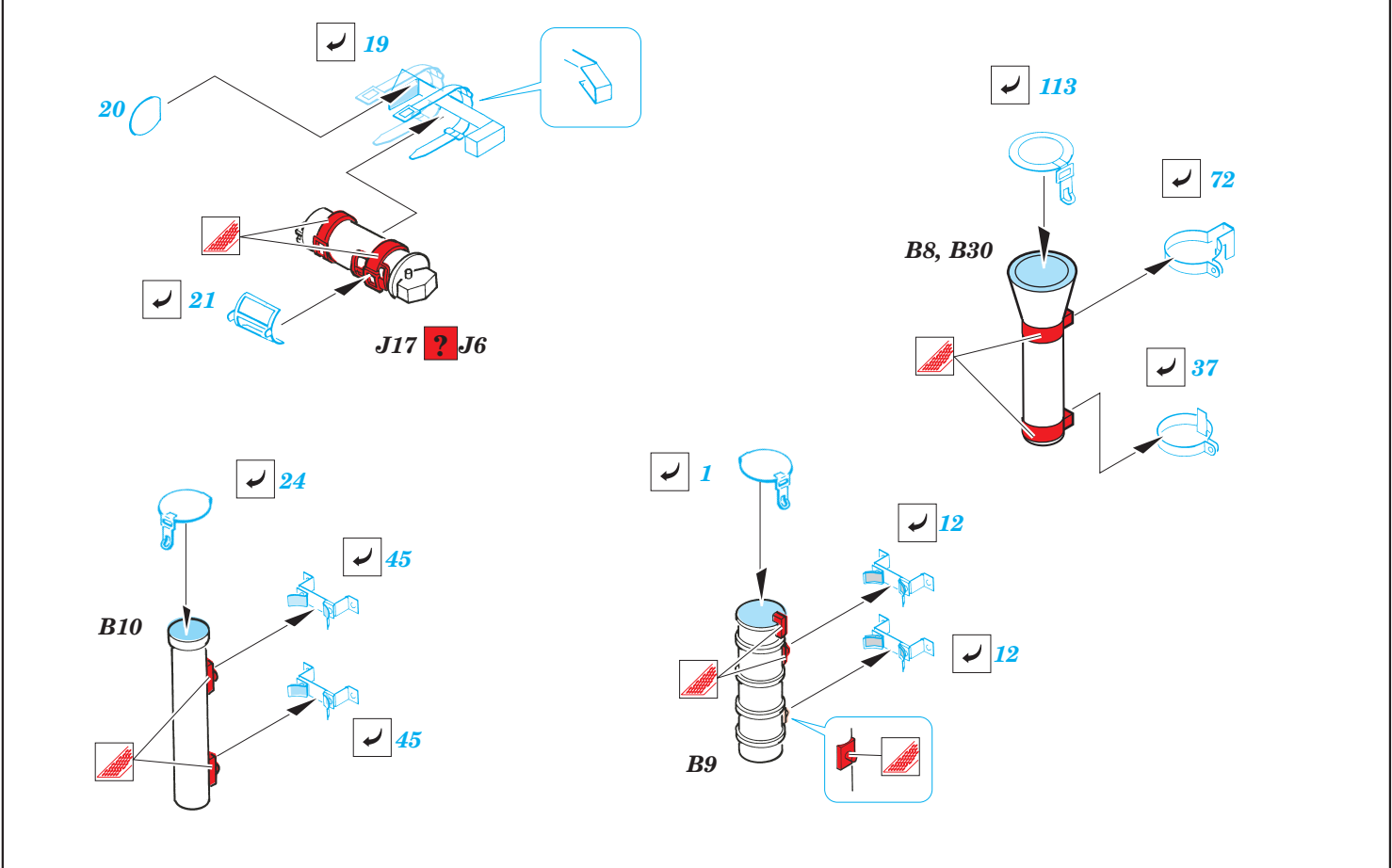
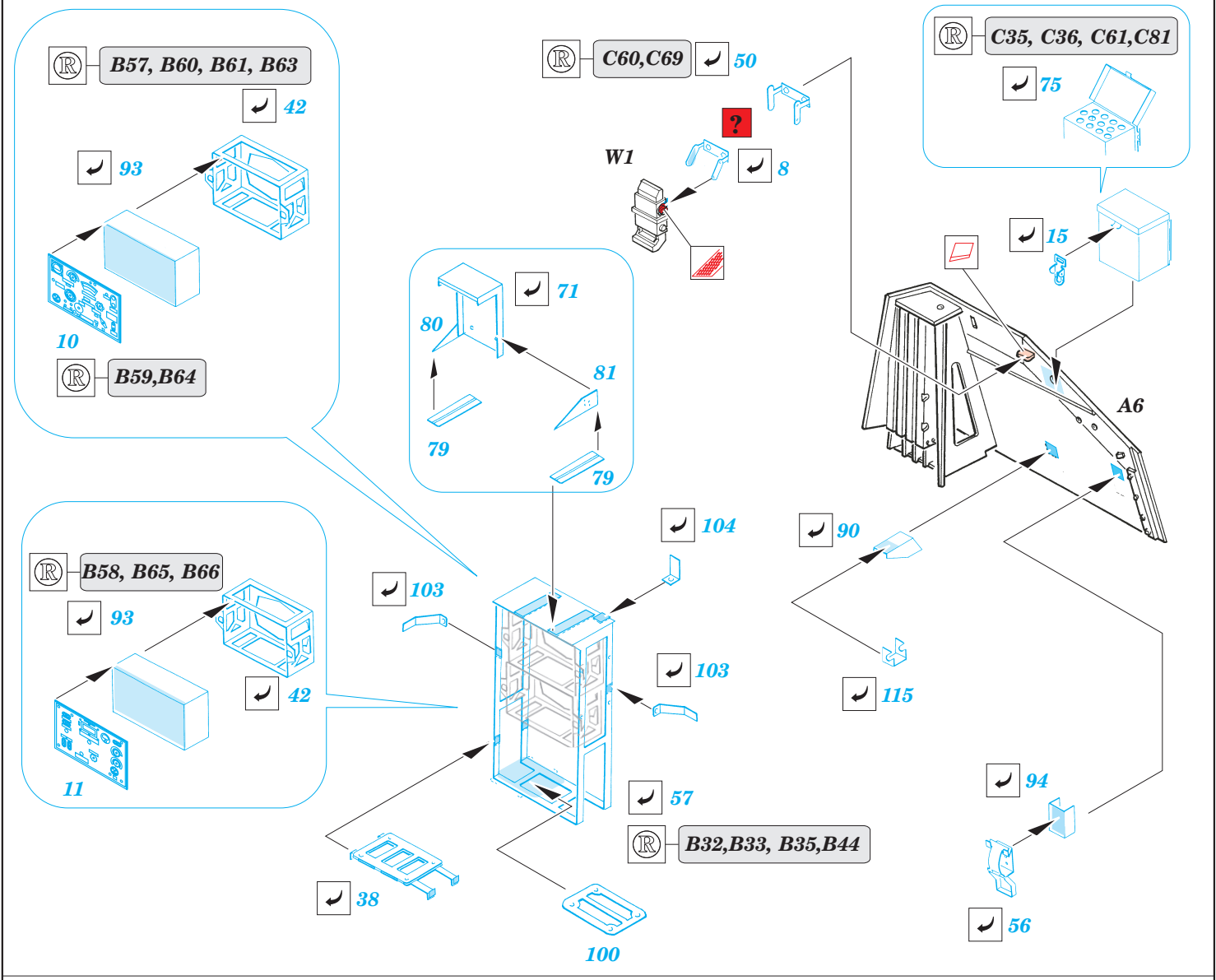

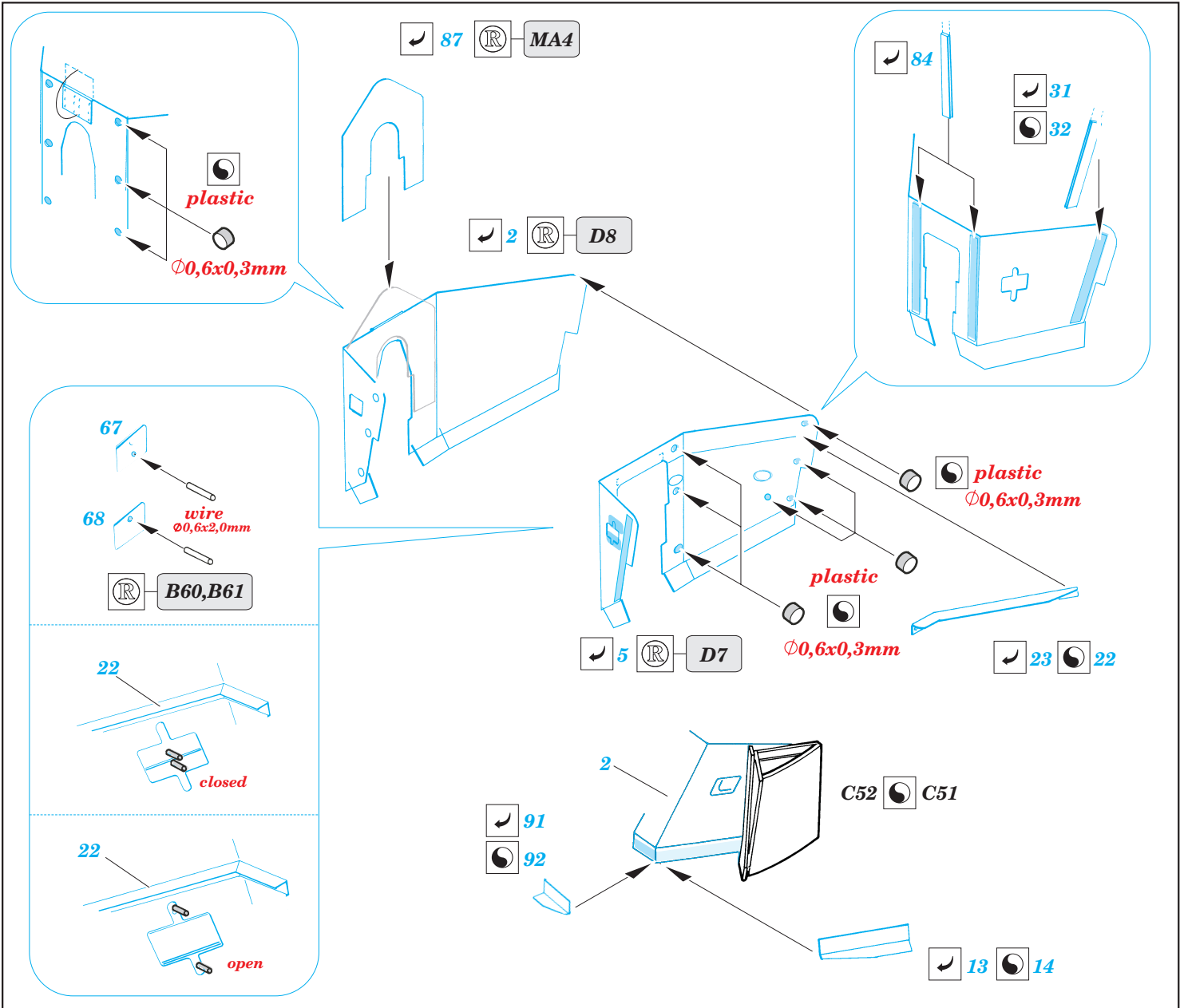

REFERENCES:

GROUND POWER #2/2000

