



WHITE ENSIGN MODELS

King George V Class Battleships

Photo Etched Metal Parts to fit the TAMIYA 1/700 scale
POW & KGV kits as the following ships:-

HMS King George V, HMS Prince of Wales, HMS Duke of York,
HMS Anson and HMS Howe

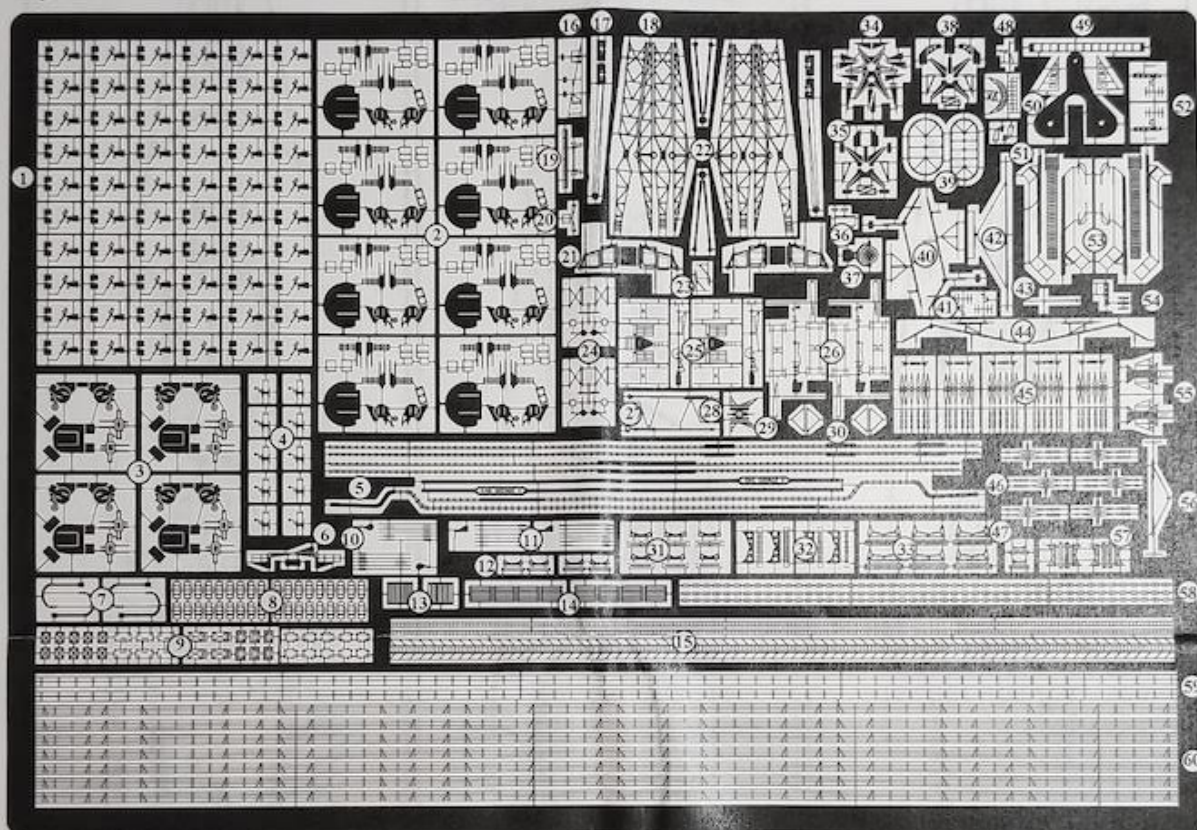



Parts List

- | | | | | | |
|-----|------------------------------|-----|--------------------------------|-----|------------------------------------|
| 1. | 20mm Single Oerlikon | 21. | Crane cab | 41. | Foremast IFF aerals |
| 2. | 8 Barrelled pom-pom | 22. | Crane jib 'A' frame | 42. | Foremast yards |
| 3. | 4 Barrelled pom-pom | 23. | ESM Aerials (late fit) | 43. | Top 86 TBS aerial |
| 4. | 20mm Twin barrels for MkV | 24. | Walrus fittings | 44. | Headache aerals (KG5/DOY) |
| 5. | KG5 Degaussing cable | 25. | 279 Radar & platform | 45. | Type 285 Yagi aerals |
| 6. | Foremast top (late fit) | 26. | 281 Radar aerals | 46. | Type 282 Yagi aerals |
| 7. | 32' Cutter davits | 27. | Jackstaff | 47. | 16' Motor dinghy cradles |
| 8. | Waffle pattern Doors | 28. | Ensign staff | 48. | IFF Interrogator aerial |
| 9. | Assorted hatches | 29. | Catapult cradle | 49. | Modified aft funnel platform (DOY) |
| 10. | 27' Whaler oars & rudder | 30. | FH3 HF/DF Aerial | 50. | Fwd funnel siren platform |
| 11. | 32' Cutter oars & rudder | 31. | 25' Motor boat cradles | 51. | Sirens |
| 12. | 27' Whaler cradles | 32. | 45' Motor launch cradles | 52. | IFF Aerals (Anson/Howe) |
| 13. | Forward ER vent grilles | 33. | 45' Motor boat cradles | 53. | Accommodation ladders |
| 14. | Aft ER vent grilles | 34. | Foremast starfish | 54. | Mainmast IFF aerial (Anson/Howe) |
| 15. | Vertical & inclined ladders | 35. | Mainmast starfish (post refit) | 55. | Main HACs tower platforms |
| 16. | Mainmast aerals (Anson/Howe) | 36. | 91 TBS aerial | 56. | 85/86 TBS aerals |
| 17. | Crane top cables | 37. | 277 Surface radar | 57. | 32' Cutter cradles |
| 18. | Crane jib | 38. | Mainmast starfish (early) | 58. | Anchor cable |
| 19. | 284 Gunnery radar | 39. | Funnel cap grilles | 59. | 2 Bar rails |
| 20. | Bridge front DF aerial | 40. | Headache aerals (Anson/Howe) | 60. | 3 Bar rails |

© WHITE ENSIGN MODELS 2000



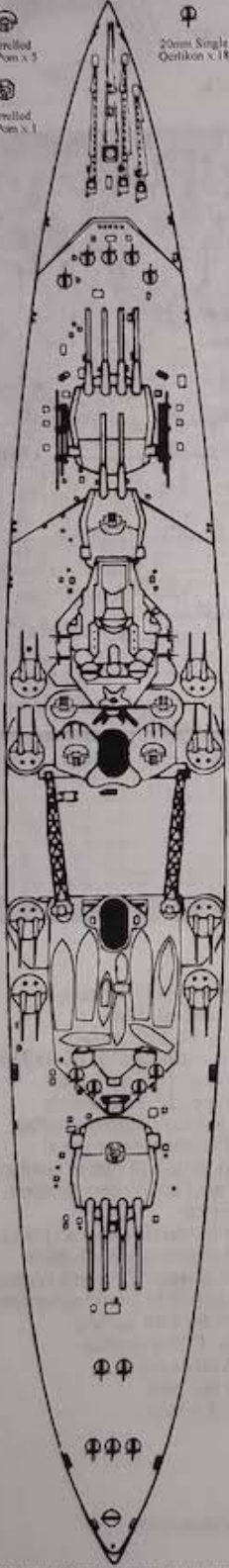

8532 Lamar drive, Huntington Beach, CA 92647 USA
Email: whitensignmodels@aol.com website: <https://www.whiteensignmodels.com>

HMS King George V Late 1941
AA Armament Plan

-  4 Barrelled Pom Pom x 5
-  20mm Single Oerlikon x 18
-  4 Barrelled Pom Pom x 1



HMS Prince of Wales Late 1941
AA Armament Plan

-  4 Barrelled Pom Pom x 4
-  20mm Single Oerlikon x 7
-  4 Barrelled Pom Pom x 2
-  Single Barrelled 40mm Bofors x 1

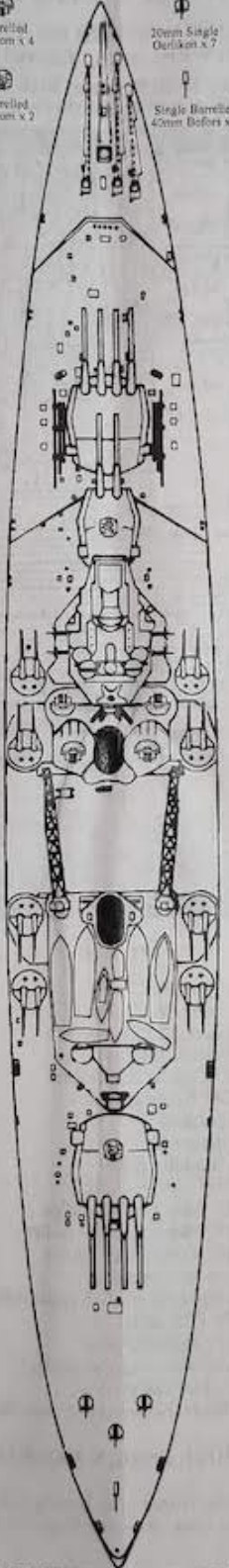



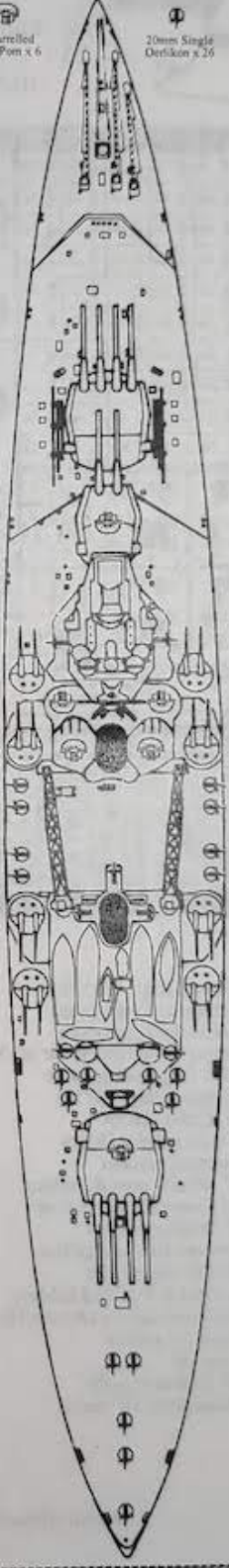

HMS Duke of York Mid 1943
AA Armament Plan

-  4 Barrelled Pom Pom x 6
-  20mm Single Oerlikon x 29







HMS Duke of York Mid 1945
AA Armament Plan

-  8 Barrelled Pom Pom x 8
-  4 Barrelled 40mm Bofors x 2
-  Twin 20mm Mk V Mounting x 8
-  4 Barrelled Pom Pom x 4
-  20mm Single Oerlikon x 36





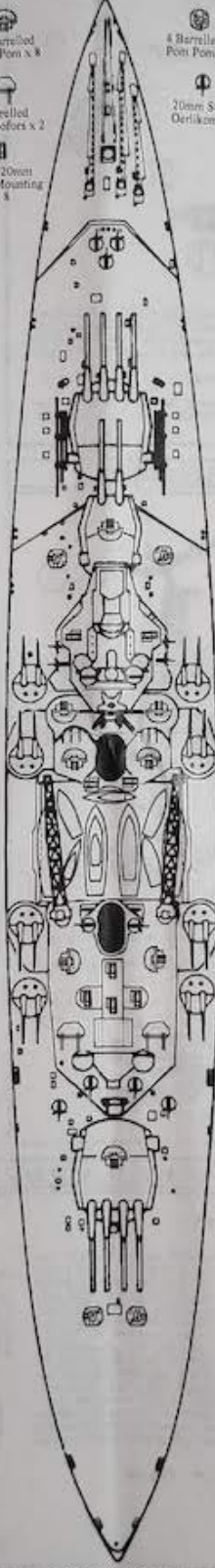

HMS Anson March 1945
AA Armament Plan

-  8 Barrelled Pom Pom x 8
-  4 Barrelled 40mm Bofors x 2
-  Twin 20mm Mk V Mounting x 8
-  4 Barrelled Pom Pom x 4
-  20mm Single Oerlikon x 24



HMS Howe Mid 1944
AA Armament Plan

-  8 Barrelled Pom Pom x 8
-  4 Barrelled 40mm Bofors x 2
-  20mm Single Oerlikon x 74
-  4 Barrelled 40mm Bofors x 2
-  Twin 20mm Mk V Mounting x 4



DEGAUSSING CABLE ROUTING & ACCOMMODATION LADDER LOCATION

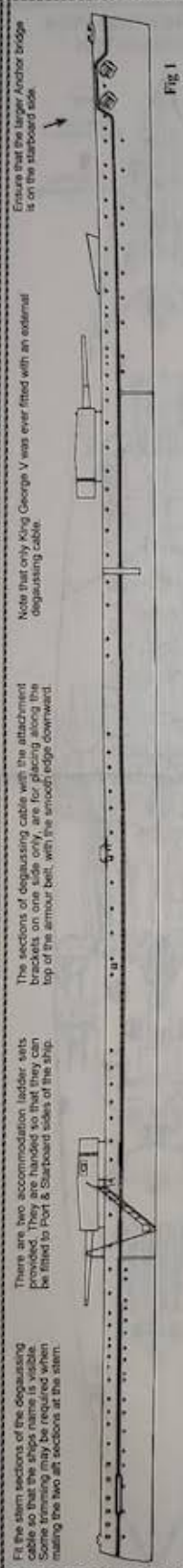

Ensure that the larger anchor bridge is on the starboard side.

Note that only King George V was ever fitted with an external degaussing cable.

The sections of degaussing cable with the attachment brackets on one side only, are for placing along the top of the armour belt, with the smooth edge downward.

There are two accommodation ladder sets provided and are handed so that they can be fitted to Port & Starboard sides of the ship.

Fit the same sections of the degaussing cable to both sides of the ship. Some trimming may be required when making the two left sections at the stern.

8 BARRELLED POM POM

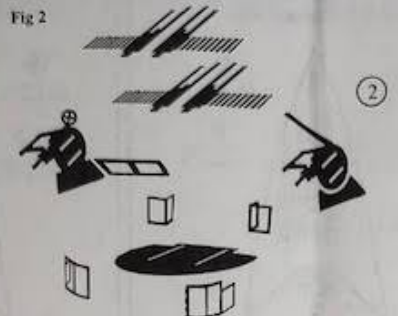

The option is given to replace the kit assemblies A25/C14 with the photo etched parts 2, provided. Assemble by sliding the ammunition boxes through the slots in the training mechanism. These parts are then joined by folding the gate round across the front and the spacer bar across the top. Fit the assembly to the slots etched into the base, then fit the railing into the positions shown. Alternatively, for the less adventurous, the railing only may be fitted to the kit assemblies A26/C35 after removing the moulded on fence.

4 BARRELLED POM POM



In some cases the ships of this class were fitted with 4 barrelled Pom Poms where it was not practical to fit, or where there was a shortage of, the larger 8 barrelled versions. Assembly is of a similar method to that of the 8 barrelled mounting in the way that the ammunition boxes slide through the slots in the training mechanism. Fold the front and back splinter shields on the base up, so that they are at 90°, and curve the back ones round to the profile of the rear of the base. In late 1941, HMS Prince of Wales had these fitted to the tops of 'B' & 'Y' turrets, with King George V, just having one fitted to 'Y' turret.

20mm SINGLE OERLIKON



Assemble photo etched 20mm Oerlikons as shown above, and use to replace kit parts C1 in the KGV kit. If you wish to model other ships of the class, please refer to the AA Armament diagrams for the correct locations of these and other weapons.

20mm TWIN OERLIKON Mk5



In later years, the ships of the KGV class were fitted with a number of these weapons. The mounting itself will have to be scratch built from waste space to the shape shown, but the barrels are provided as photo etched parts 4 on the fret. Refer to the AA Armament diagrams for date and location of these items.

MAINMAST STARFISH ASSEMBLIES

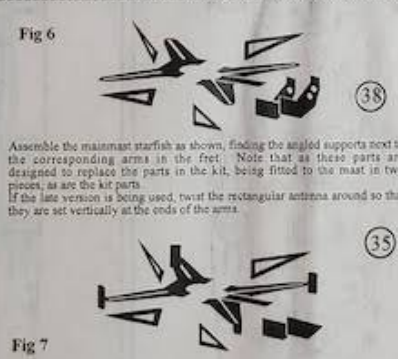

Assemble the mainmast starfish as shown, fitting the angled supports next to the corresponding arms in the fret. Note that as these parts are designed to replace the parts in the kit, being fitted to the mast in two pieces, as are the kit parts. If the late version is being used, twist the rectangular antenna round so that they are set vertically at the ends of the arms.

FOREMAST STARFISH ASSEMBLY

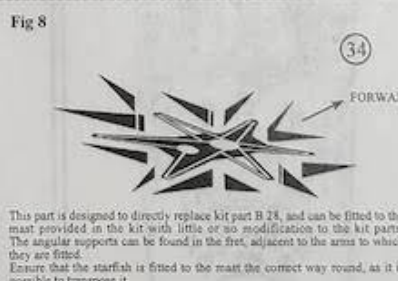

This part is designed to directly replace kit part B 24, and can be fitted to the mast provided in the kit with little or no modification to the kit parts. The angular supports can be found in the fret, adjacent to the arms to which they are fitted. Ensure that the starfish is fitted to the mast the correct way round, as it is possible to transpose it.

279 & 281 RADAR AERIAL ASSEMBLY

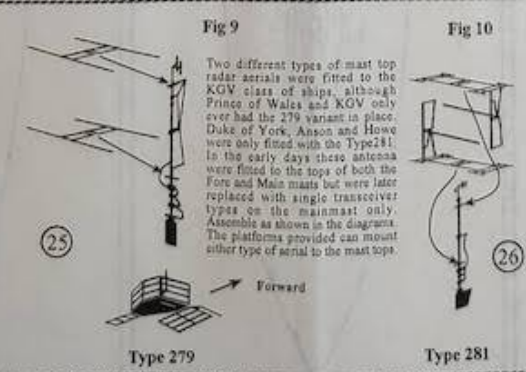

Two different types of mast top radar aerials were fitted to the KGV class of ships, although Prince of Wales and KGV only ever had the 279 variant in place. Duke of York, Anson and Howe were only fitted with the Type 281. In the early days these antenna were fitted to the tops of both the Fore and Main masts but were later replaced with single transceiver types on the mainmast only. Assemble as shown in the diagram. The platforms provided can mount either type of aerial to the mast tops.

FUNNEL SIREN PLATFORM

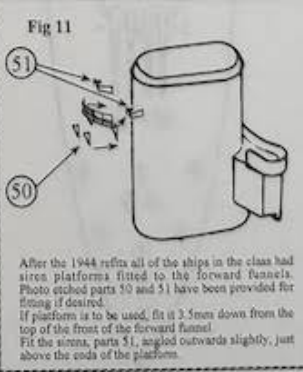

After the 1944 refits all of the ships in the class had siren platforms fitted to the forward funnels. Photo etched parts 50 and 51 have been provided for fitting if desired. If platform is to be used, fit it 3.5mm down from the top of the front of the forward funnel. Fit the sirens, parts 51, angled outwards slightly, just above the ends of the platform.

FUNNEL CAP GRILLES

Fig 12

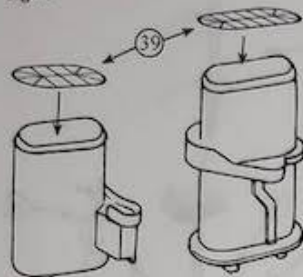

Fit funnel cap grilles as shown above, with the longer narrower grill to fit on the aft funnel.
Once fitted in place and securely glued, the centre of the grilles may be carefully lifted with tweezers to form a dome shape.

AA ARMAMENT DIRECTOR AERIALS

Fig 14

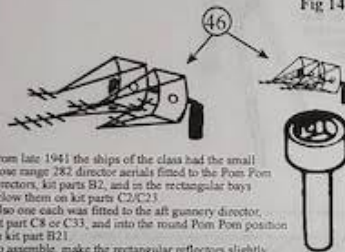

From late 1941 the ships of the class had the small close range 282 director aerials fitted to the Pom Pom directors, kit parts B2, and in the rectangular bays below them on kit parts C2/C3.

Also one each was fitted to the aft gunnery director, kit part C8 or C33, and into the round Pom Pom position on kit part B21.
To assemble, make the rectangular reflectors slightly concave, then fold the long central aerial back so that the end fits into the hole in the reflector. Pinch the 'V' shaped sections together and glue into place, folding the short aerial section to point outward.
The mounting brackets on each side can be folded directly downwards to fit into the director position.

Fig 15



285 Long Range AA Radar

Assemble by fitting the central aerial array into the holes in the reflector, after first imparting a curve to the reflector dishes. Keep the central aerials linked together by the joiner tab, for easier assembly.
Fold the 'V' shaped sections round and pinch them together onto the central aerials. Glue into place.
Fit the mounting hooks onto the top bar on the main HACs directors, kit parts B3/B4, and fit the main assembly into the hooks.

As the ships of the class were completed and entered service they already had these items fitted, with the exception of the King George V, which had them fitted in mid 1942.

SUPERMARINE WALRUS AMPHIBIAN

Fig 13

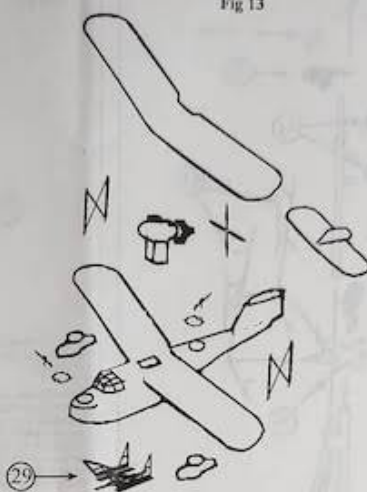

The Supermarine Walrus amphibian that is provided in the Prince of Wales kit is basically sound and needs only the addition of photo-etch to finish off, with the following exceptions:

1. Drill out the gunner's cockpits with a .65mm drill and fit the Scarff rings and machine guns as shown.
2. A launching cradle has been provided in the first as etched part 29.
Fold into the shape shown below.
3. Assemble the wings as shown in the kits instructions, but include the struts and cross braces as shown.

The paint scheme for the Walrus at the time period depicted by the kit is as follows:
Dark Slate Grey / Extra Dark Sea Grey Camouflage Pattern.
Upper surfaces of fuselage, tailplane and Upper wing only.

Slate Grey / Dark Sea Grey Camouflage Pattern.
Upper surface of Lower wing only.

Mat Sky Type S.
All undersurfaces.

Mat Black.
Prop Blades, Wheels, Machine guns.

Decals can be found on the White Ensign 1/350 / 1/700 scale aircraft decal sheet, that are suitable for use on this aircraft in the form of red/blue roundels for the upper wing surfaces.

284 GUNNERY RADAR

Fig 16



Assemble photo etched part as shown and fit to the top of kit part C1 or C22, after first removing the moulded on item.

FOREMAST TOP PLATFORM

Fig 18



If the post 1944 refit versions are being modelled then the foremast will require the modified top platform that is provided by photo etched part 6.
Assemble as shown above and fit to foremast as shown in Fig 24.

HACs TOWER PLATFORMS

Fig 17

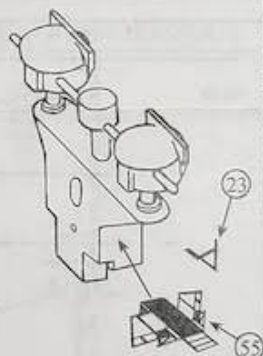

It appears that these platforms were fitted to all ships of the class in the 1944/45 period, prior to service in the Pacific fleet. Assemble by folding up the railings as shown, on the sides and end. The triangular brackets at the inner end of the platform are folded downwards to provide a mounting support. The ESM aerials are fitted to the ends of the HACs tower, kit part B5, above the platform.
Repeat the fitting procedure on the opposite side of the tower.

MAIN CRANE & CAB ASSEMBLY

Fig 19

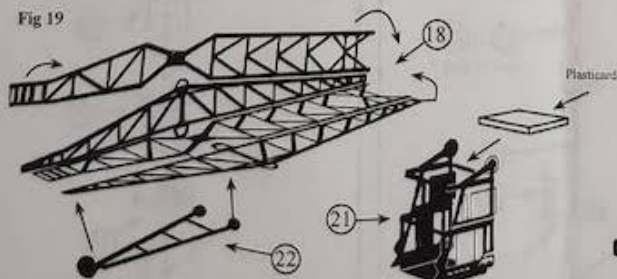

Assemble the photo etched parts 17, 18, 21 and 22 as shown above, to replace the main ship's cranes provided in the kit as parts B14, B16, B17 and B18. Remove the lower part of B18 for use as a mounting for the new cab assembly.
Make a roof plate for the cab out of a square of 20 thou (.5mm) Plasticard, to mount the cable pulley housing onto. Note. The cable pulley housing is etched so that it can be folded back on itself to provide roof etching on both sides.
Repeat procedure for second crane.

Fig 20

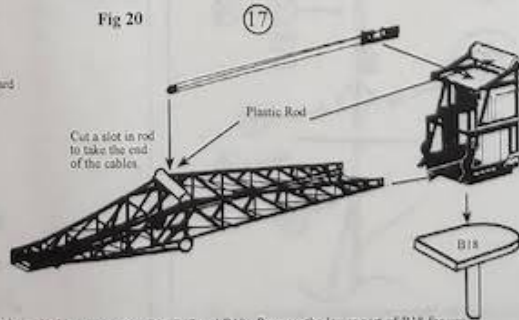

Cut a slot in rod to take the end of the cables.

Plastic Rod

Plasticard

Note. The cable pulley housing is etched so that it can be folded back on itself to provide roof etching on both sides.

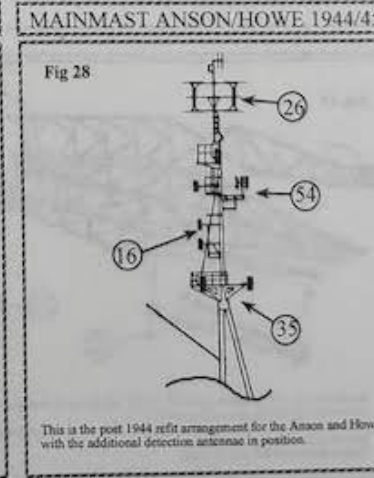
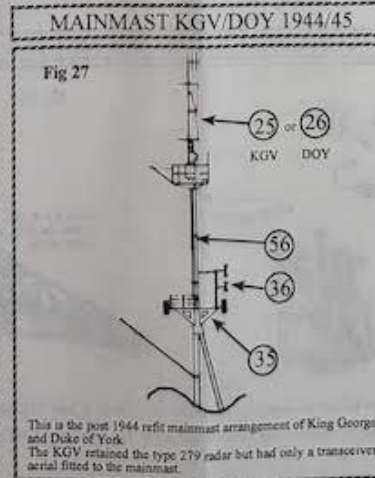
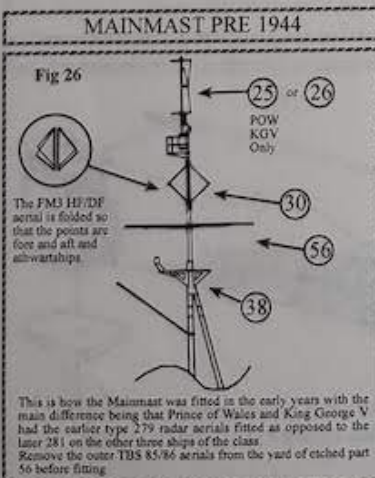
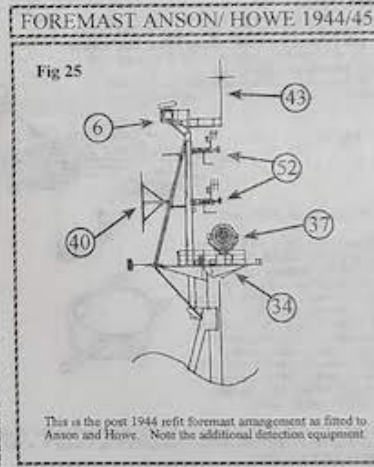
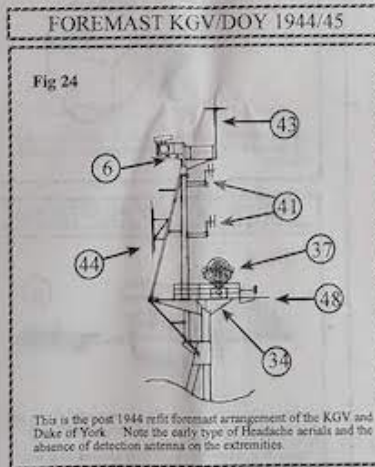
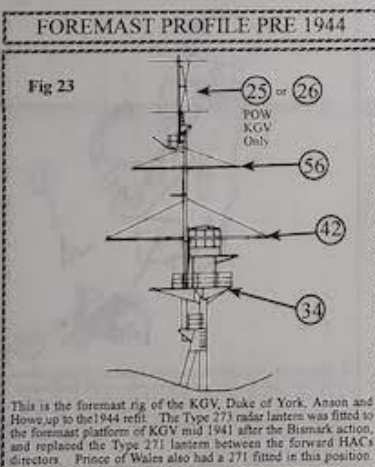
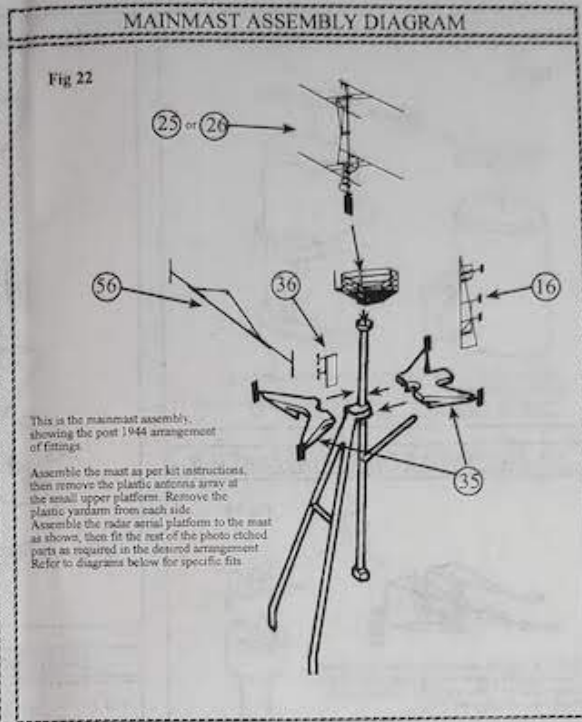
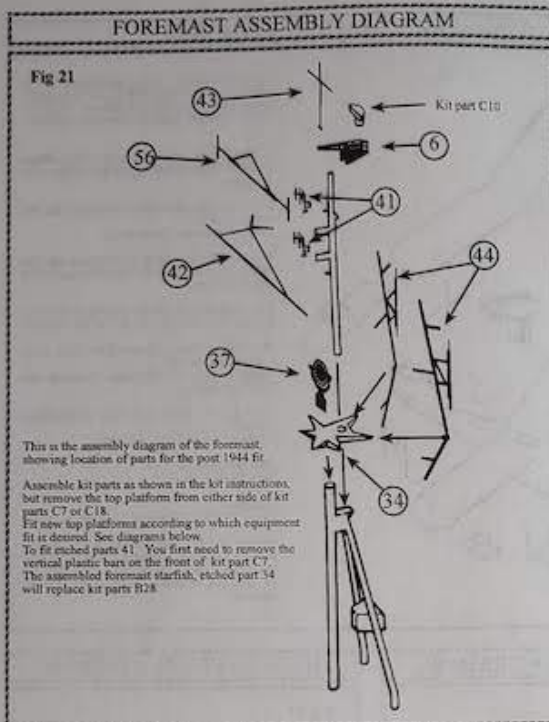

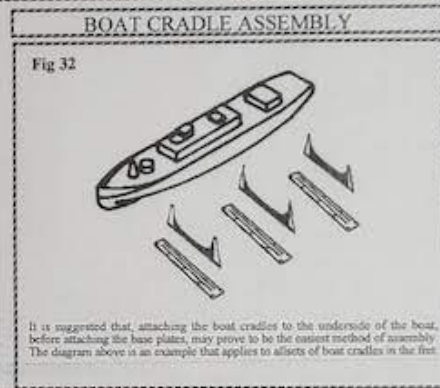
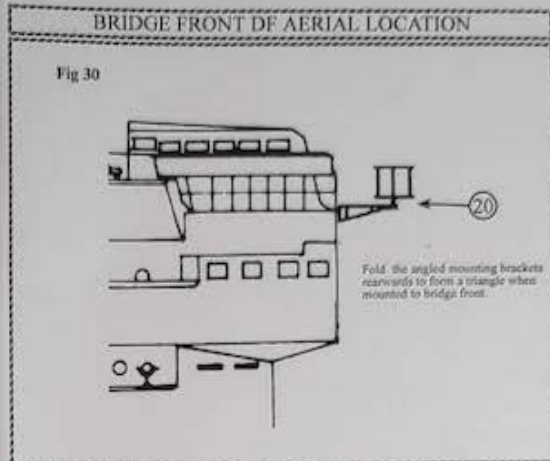
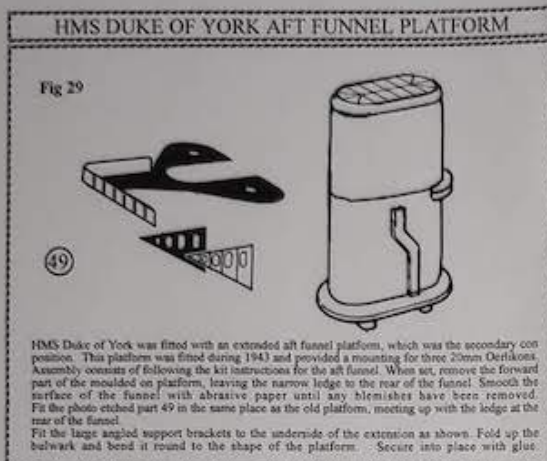

Notes

1. Whilst every effort has been made to provide as much information as possible in a simplified form, it is recommended that each subject modelled from this set is researched further and details that have been provided are confirmed.
2. References used for creating this product are as follows. British Battleships of World War 2 by Alan Raven and John Roberts. King George V Class Battleships by V.E. Tarrant and Ensign 1, King George V Class Battleships by Alan Raven. The latter reference also provides a good camouflage paint guide for every ship of the class.
3. A selection of water tight doors and hatches has been provided along with enough railings and ladders to furnish the ship accurately if it is desired to add these details. The aft Vent grills can simply be wrapped around the moulded boxes to which kit parts B11 are fitted.
4. Replacement davits for the 32' Cutters that are optionally fitted to the fore deck, (Kit parts A4) are provided as are oars and rudders for the ships boats should it be desired to fit them.

General Instructions

1. Do not remove the etched parts from the fret until you are ready to use them.
2. Before assembly, soak the etched parts in a suitable solvent, such as white spirit, to de-grease the surfaces for painting.
3. Cyanoacrylate adhesive (Super glue) or contact adhesive such as Elmers white glue may be used. These can be applied with a pin or piece of stretched sprue.
4. When removing parts from the fret, place the fret on a hard surface, such as a smooth ceramic tile, in order to prevent parts bending whilst cutting through the holding tabs. It is suggested that a #11 type of modelling knife blade is used for this purpose.
5. When shaping or bending a part, a straight edged blade such as a chisel blade #17 or #18 will give a good sharp corner, or alternatively a small pair of smooth jawed pliers may be used.
6. If a part is bent incorrectly, lay it on a hard flat surface and roll it flat with a cylindrical object such as a modelling knife handle.
7. It is suggested that rails are pre-measured, where practical, using a pair of compass dividers and then tacked to the deck edge every third or fourth stanchion with a small drop of glue. When a section is complete, run a thin line of glue along the inside edge to attach it firmly to the deck.

We hope that you will find this set to your satisfaction and that you enjoy assembling the fittings to the kits.

**HAPPY MODELLING
FROM ALL AT
WHITE ENSIGN MODELS**