

AZ model
Plastic kits

LET L-410 UVP & UVP-E "TURBOLET"

Plastic model

scale : 1/72

History note

Development of the L-410 was started in the 1960s by the Czechoslovak aircraft manufacturer Let Kunovice. The Soviet airline Aeroflot was looking for a turbine-powered replacement for the Antonov An-2 aircraft, initiating the design development by Let. After preliminary studies of an aircraft called the L-400, a new version was introduced called the L-410 Turbolet. The first prototype, designated XL-410, flew on April 16, 1969. Because of delays in the development of a suitable Czech engine (Walter M601), the prototype and first production version were powered by Pratt & Whitney Canada PT6A-27 engines.

After M601 development was completed, the PT6 engine was replaced by M601 engines coupled with Avia V508 three-blade propellers and the next variant was introduced, the L-410M.

A further version for Aeroflot was the L-410 UVP. This has improved performance in take-off and landing due to increased wing and tail area + STOL. However, due to an increased empty weight and a shift in the center of gravity, the aircraft had a decreased seating capacity: 15 passengers.

The L-410UVP-E (the most common variant of the L-410) has increased maximum take-off weight to 6400 kg, M601E engines with increased power, new five-blade propellers designated V 510 and the provision for wing tip tanks to increase fuel quantity. First flight was made in 1984, and production started in 1986.

The L-410UVP-E9 and UVP-E20 are versions which vary from each other only by minor changes arising from various certification regulations. The last L-410 family member is the L-420 which uses the new Walter engine variant, the M801F.

The L-410 UVP-E is an unpresurized all-metal high-wing commuter aircraft, with Avia V 510 five-blade propellers. It is equipped with a retractable undercarriage. The aircraft uses two hydraulic circuits: main and emergency. The main electrical system operates with 28V DC. The de-icing system is leading edge pneumatic deicers and electrical heating of propellers, cockpit windshields and pitot-static system heads. Maximum take-off weight of the L-410 UVP-E is 6400 kg with the possibility of an increase to 6800 kg for the E9 and E20 variants, seating capacity 17 to 19. Cruise speed is 170 KIAS, maximum range about 770 nautical miles (1,430 km). The airplane is certified for IFR operation, CAT I/LS approach, and flights in icing conditions.

Plastic parts

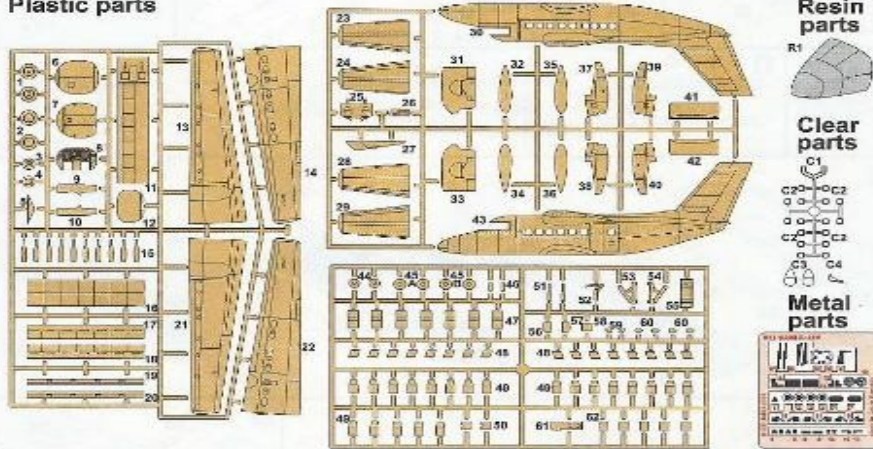

Resin parts



Clear parts



Metal parts



Symbols



	Colour name	Humbrol	Colour name	Humbrol
A	Black	H33	Aluminium	H56
B	White	H34	Silver	H11
C	Light Grey	H147	Gull Grey	H140
D	Gunmetal	H53	Red	H132
E	Blue	H14	Tyre	H85
F	Yellow	H24	Rust	H113

Assembly instructions

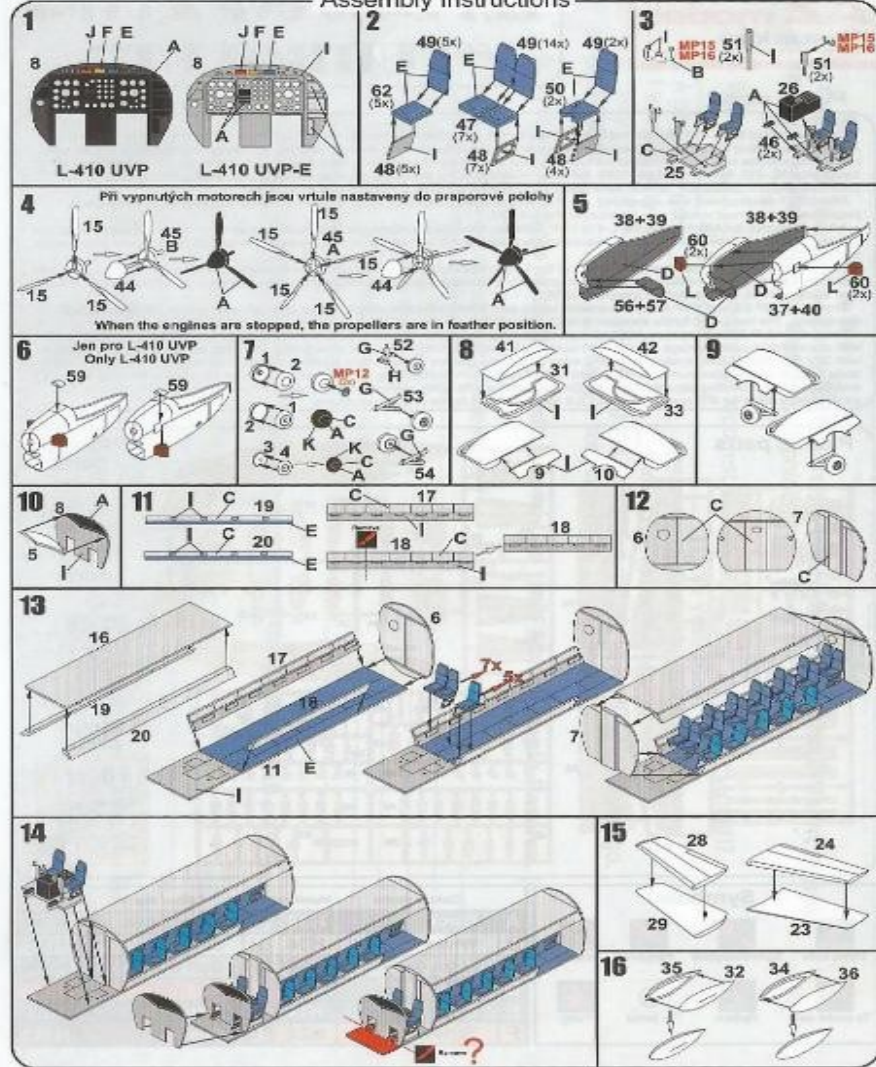

Assembly instructions

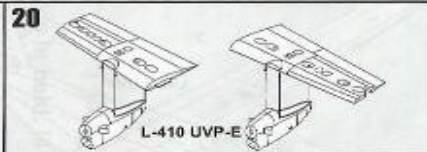
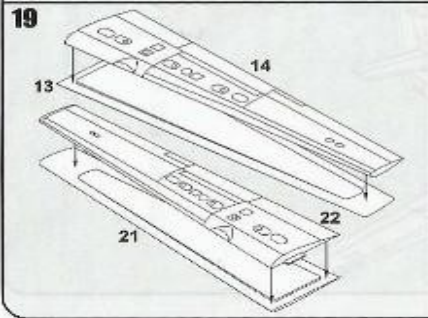
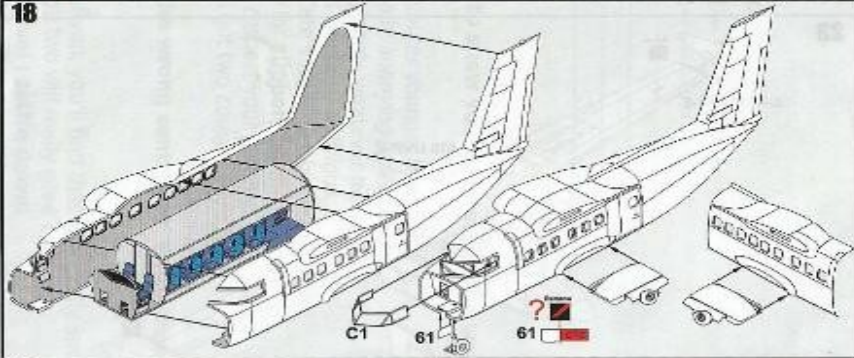
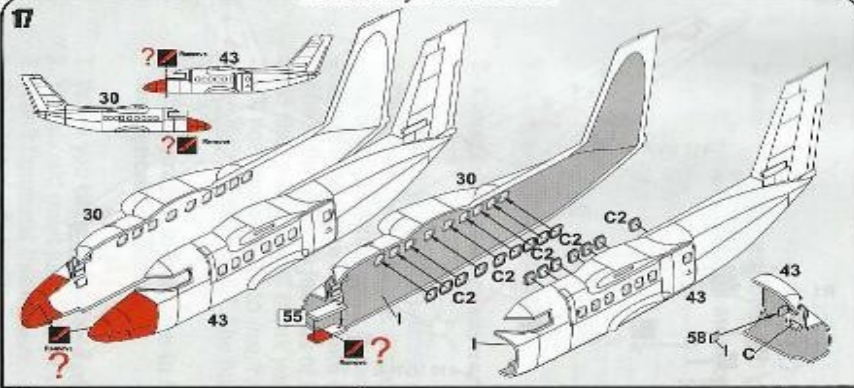

Assembly instructions

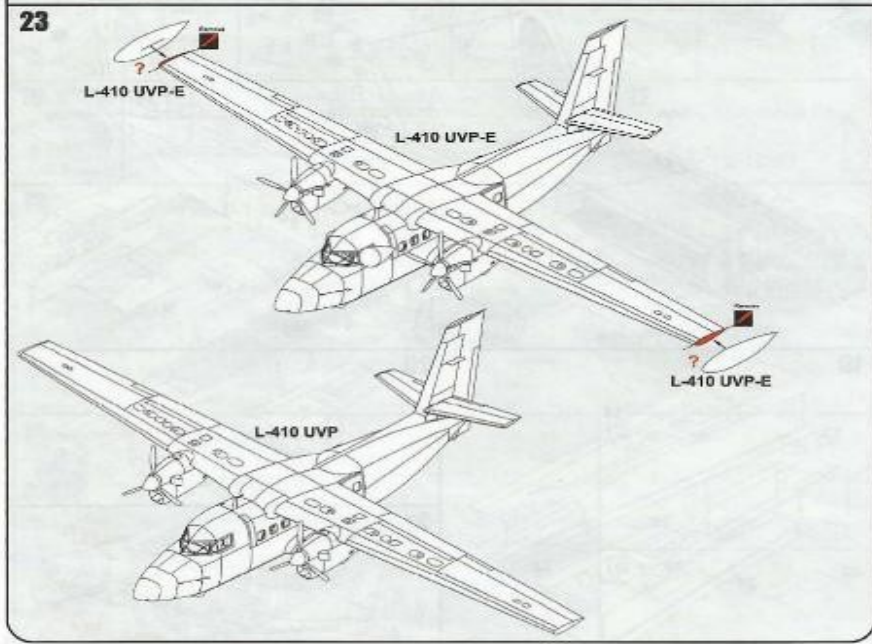
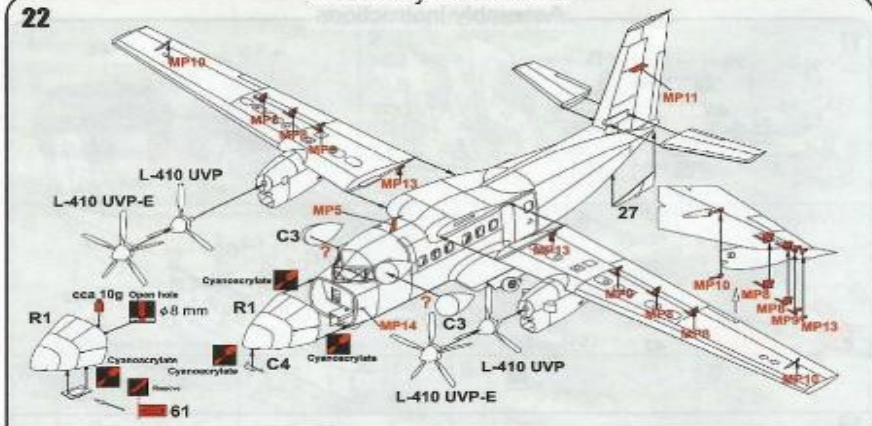

1. L-410 UVP-E, OK-TCA

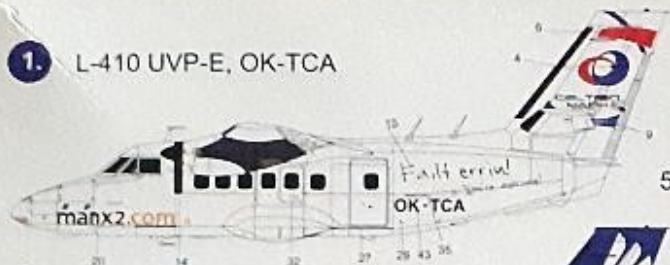

5 blade propeller

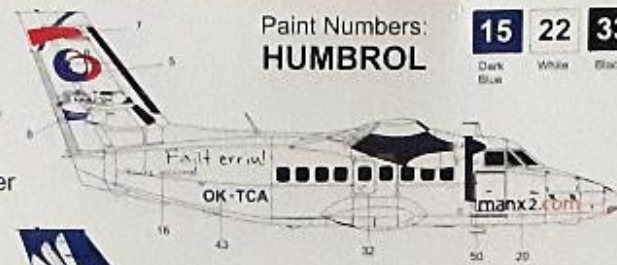

Paint Numbers:
HUMBROL

15	22	33	56
Dark Blue	White	Black	Aluminium



2. L-410 UVP-E, SP-FTN



5 blade propeller



3. L-410 UVP, OK-UBA



5 blade propeller

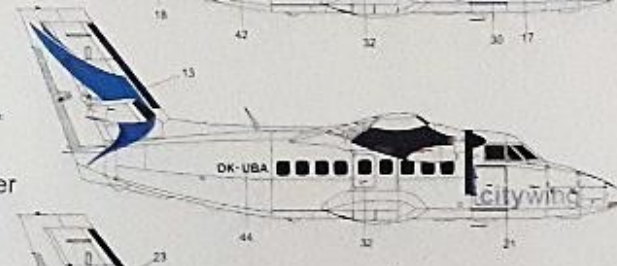

4. L-410 UVP-E, LZ-CCS



5 blade propeller

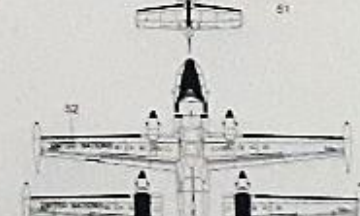
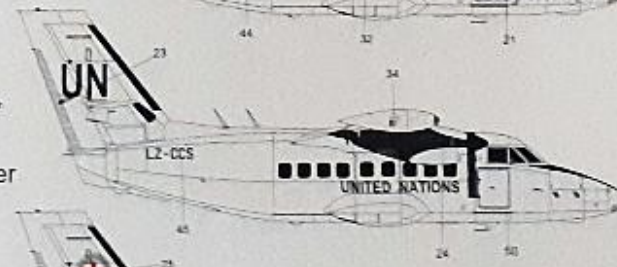

5. L-410 UVP-E, ZS-DIH

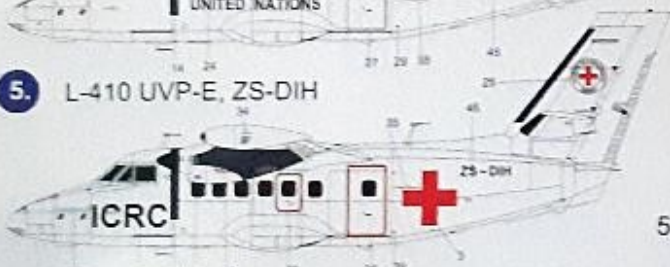

5 blade propeller



