

Cat. no: 72902

Scale: 1:72

MiG-29UB in Ukrainian Air Force

READ BEFORE ASSEMBLY:

- This kit is not recommended for inexperienced modelers or for children under 14 years of age
- Study and understand these instructions thoroughly before beginning assembly
- When needed, remove photo-etch parts carefully using a modeling knife or photo etch sprue cutter, being careful not to damage or lose small parts.
- Take extra care in handling photo etch parts in order to avoid injury
- Apply instant cement sparingly to photo etch parts where instructed

- Tools recommended(not included in kit):Plastic and instant cements,sprue cutters,long nose pliers,modeling knife, small files, tweezers, pin vise & scissors. Soft cloth and sandpaper will also assist in construction
- Glue and paint are not included in the kit. Use plastic cement and hobby paints only. Color guide for purchasing paint is included in the kit.
- Keep out of reach of children. They must not be allowed to ingest small parts or handle plastic bags in any way.

装配之前仔细阅读

- 小心用模型锉刀锉平所有零件表面的注射浇口。
- 小心用刀片切下蚀刻片零件，不要遗失小零件。
- 用强力快干胶水粘合蚀刻片零件和金属轴。过量的快干胶水使用可能导致可动零件会粘住，小心涂胶。
- 取蚀刻片时应特别注意安全，防止利边划伤手指。
- 某些零件表面需贴水贴纸，请选择在装配的同时进行。
- 推荐模型工具(自备)：胶水，水口剪刀，长咀钳，刀片，锉刀，镊子钳，钻，剪刀，瞬间快干胶。
- 软布同砂纸同时也应该是必备工具。
- 请使用塑料胶水和油漆，模型内不含。
- 谨防小孩吸吮塑料零件，或者将塑料袋套在头上，制作时应将套材远离小孩接触。
- 本产品不适合14岁以下没有经验的模型爱好者。

水贴纸的使用:

1. 从水贴纸上剪下印花;
2. 将印花放入温水中浸10秒, 然后放在干净布上。
3. 拿着印花纸板将印花移到模型上;
4. 手指蘸水将印花移到适当的位置;
5. 用软布轻压印花直至水干, 气泡消失。

DECAL APPLICATION:

1. Cut decals from sheet as needed
2. Dip the decal in warm water for about 10 seconds and then place on soft clean cloth.
3. Hold the decal backing sheet edge and gently slide the decal onto the model in its proper position.

4. While still wet,decal can be adjusted for better fit on model by dampening it gently with your finger.
5. When placed in the proper position,gently press decal down with a soft cloth until excess water and air bubbles are gone.
6. Allow decal to dry completely before handling model



部品图 Parts

《上机身》
Top fuselage

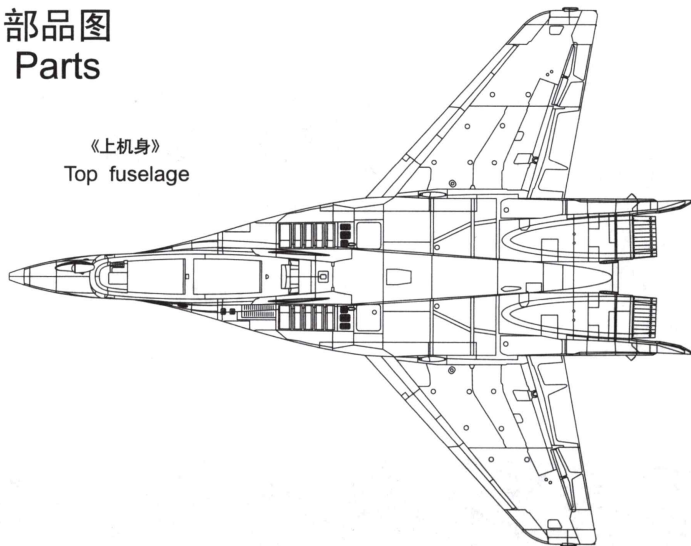

《下机身》
Lower fuselage

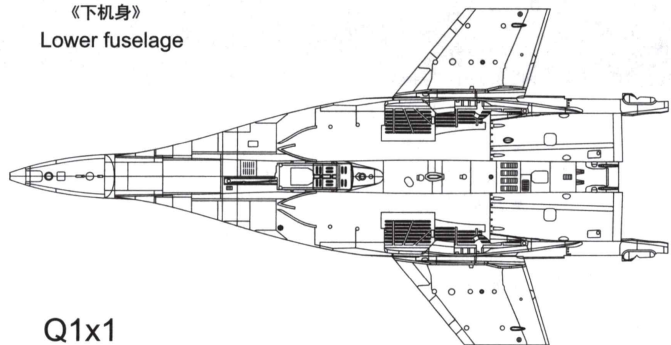

Q1x1

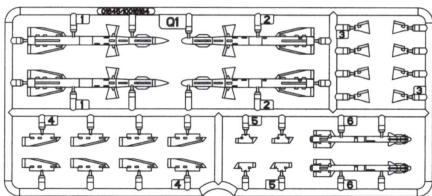

Mx1

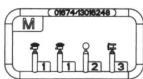

Vx1

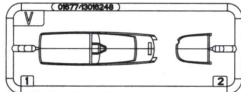

Gx1

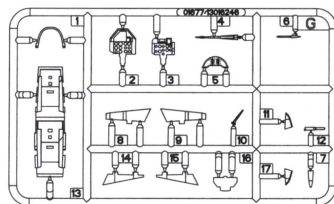

Hx1

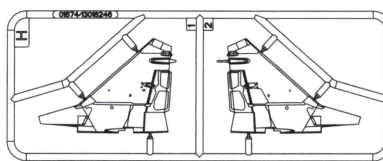

Dx1

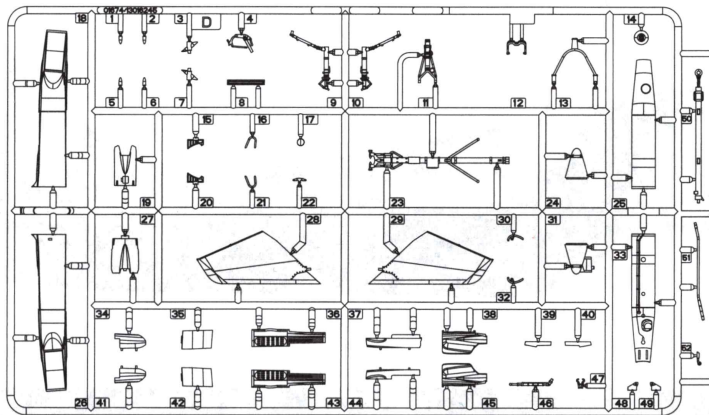

Jx2

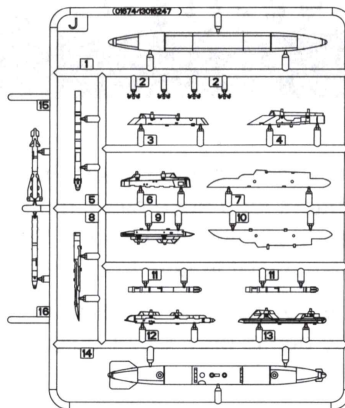

Kx2

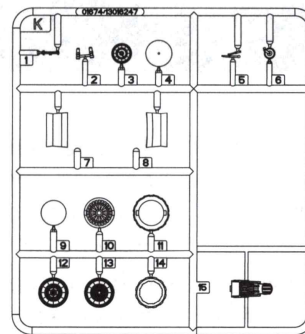

不用的部件: D14 D24 D25 D30 D31 D32 D33 D48 D49 J1 J2 J3 J4 J6 J7 J8
Unused parts J10 J14

Recommended Paints List

	VALLEJO	HATAKA	AK INTERACTIVE
Agate Grey	A 71.121	HTK-_048	RC220
Silver Grey	B 71.051	HTK-_334	RC261
Mouse Grey	C 71.259	HTK-_335	RC279
Traffic Blue	D 70.809	HTK-_220	RC010
Sky Blue	E 70.844	HTK-_320	RC291
Light Sky Blue	F 70.841	HTK-_321	RC239
Orange Yellow	G 77.078	HTK-_066	RC267
Light Blue	H 70.961	HTK-_229	RC239
Dusty Grey	I 71.047	HTK-_249	RC215
Window Grey	J 71.050	HTK-_334	RC050
Torquoise Green	K 71.347	HTK-_019	RC260
Leaf Green	L 70.968	HTK-_091	RC232
Black Red	M 70.859	HTK-_087	RC031
Beige Red	N 70.804	HTK-_306	RC227
Flat Grey Green	O 71.340	HTK-_709	RC311
Dark Gull Grey	P 71.277	HTK-_044	RC247
Black	R 71.057	HTK-_041	RC082
Jet Exhaust	Q 77.713	HTK-_078	RC020
Satin White	S 71.001	HTK-_101	RC004
Red	T 71.003	HTK-_276	RC005
Jet Black	U 70.861	HTK-_100	RC001
Light Blue (cockpit)	W 71.101	HTK-_314	RC280
Silver	X 71.067	HTK-_003	RC020

《水贴纸》A
Decal A

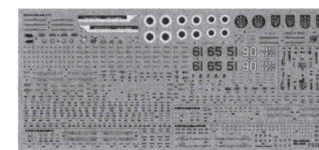

《水贴纸》B
Decal B



1

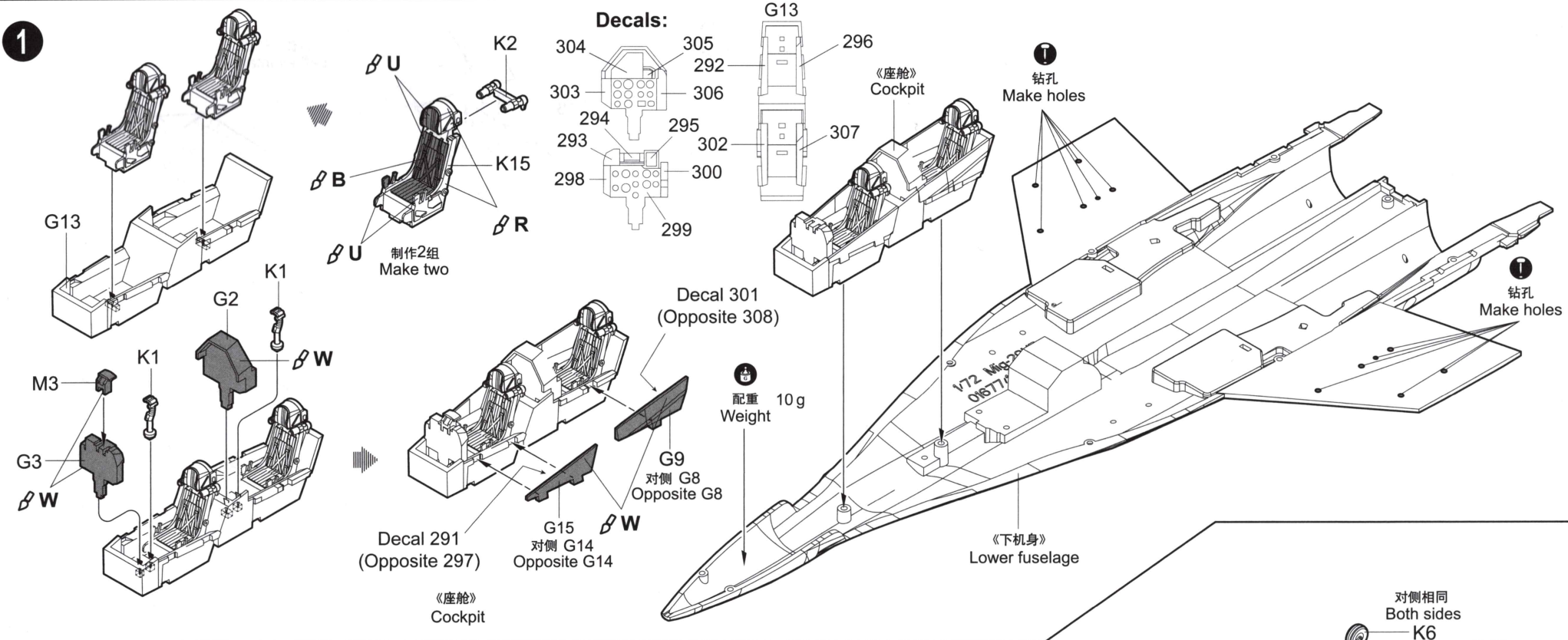

2

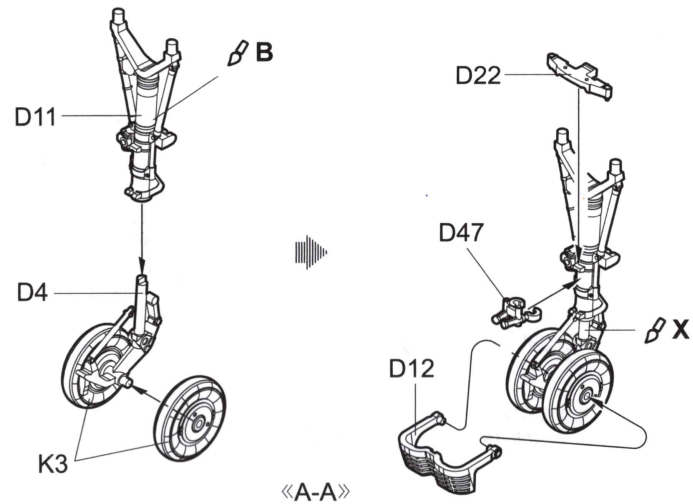

3

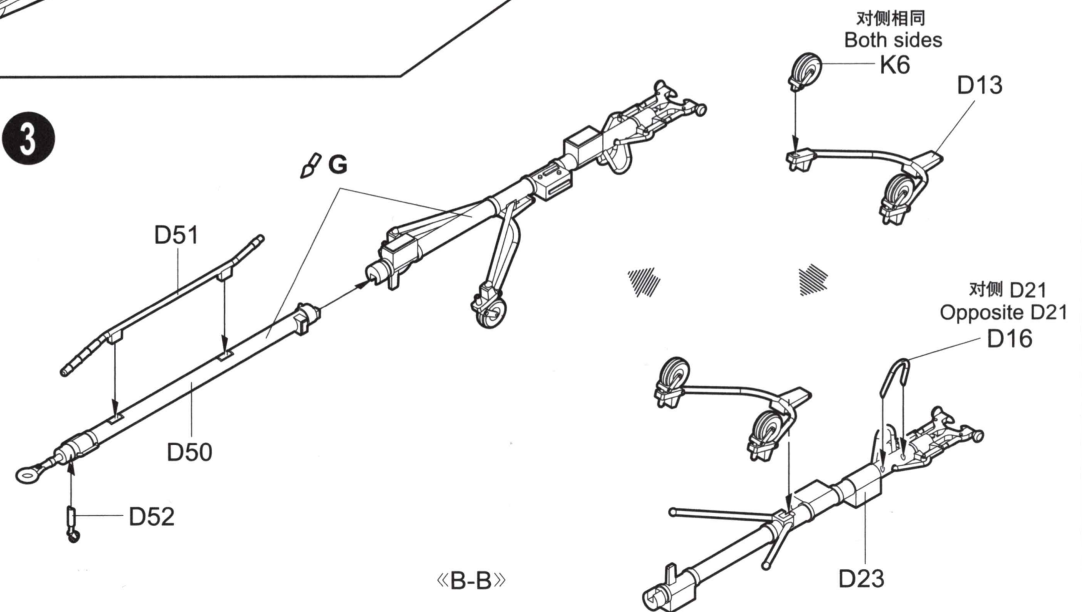

4

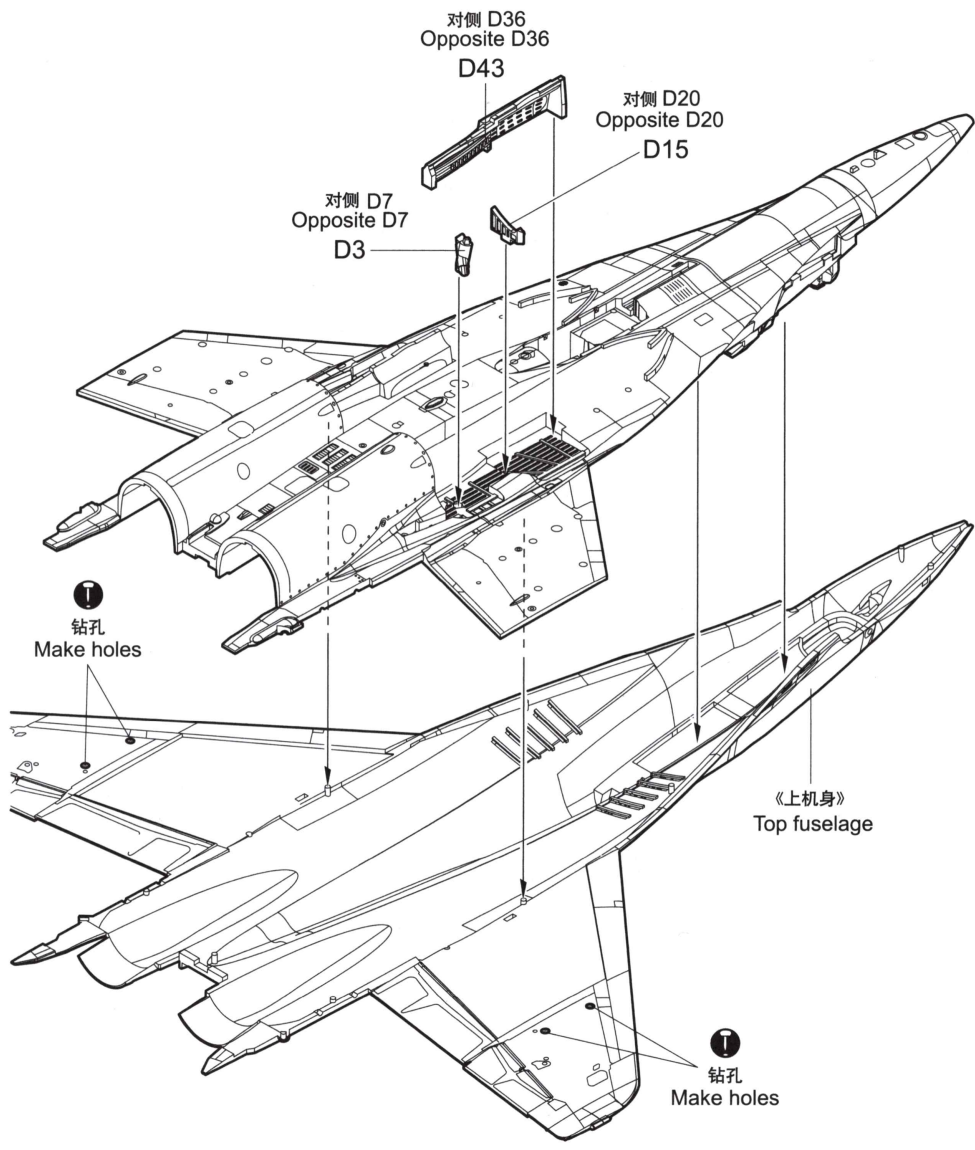

5

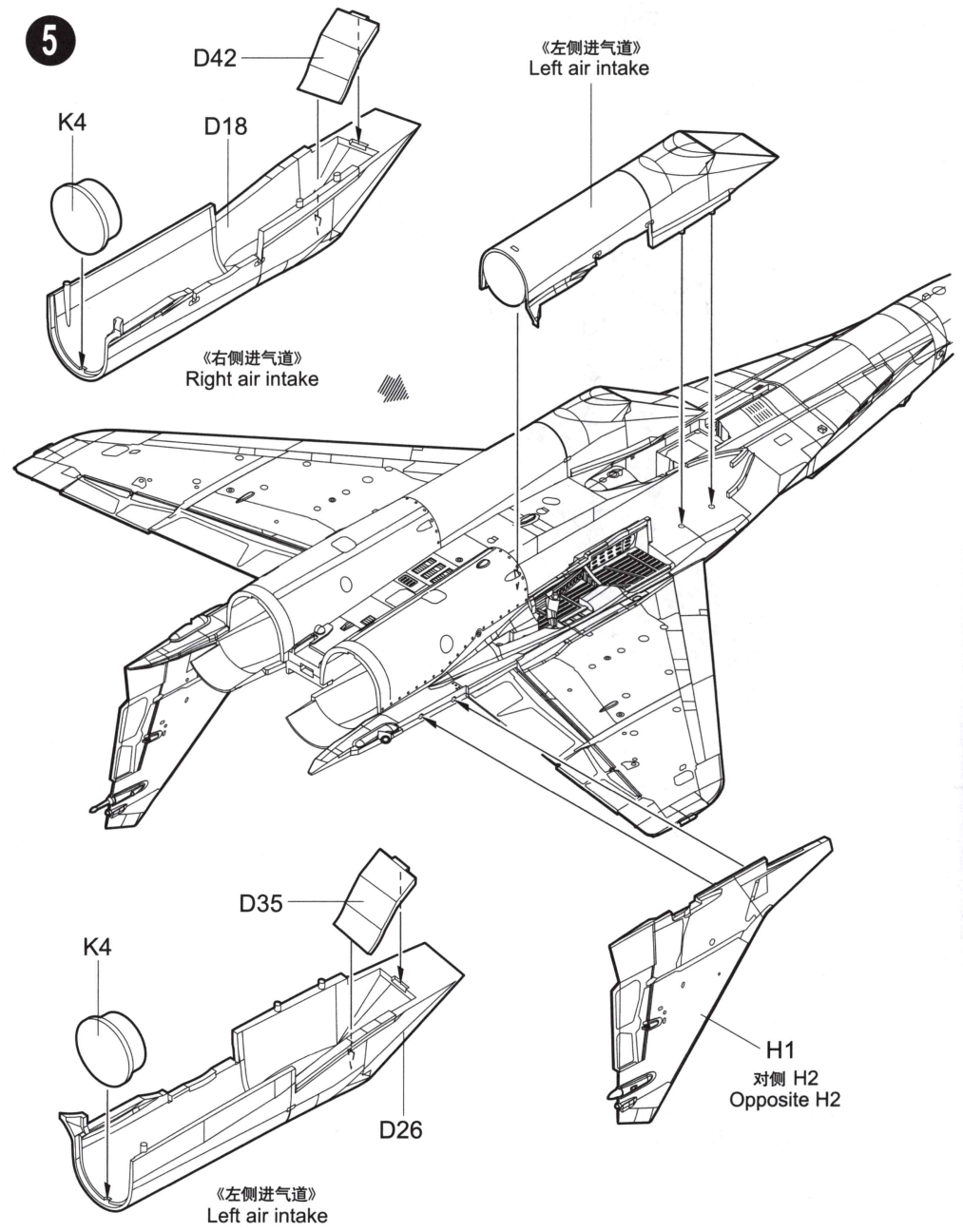

6

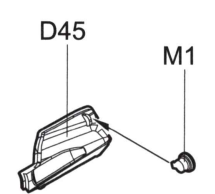
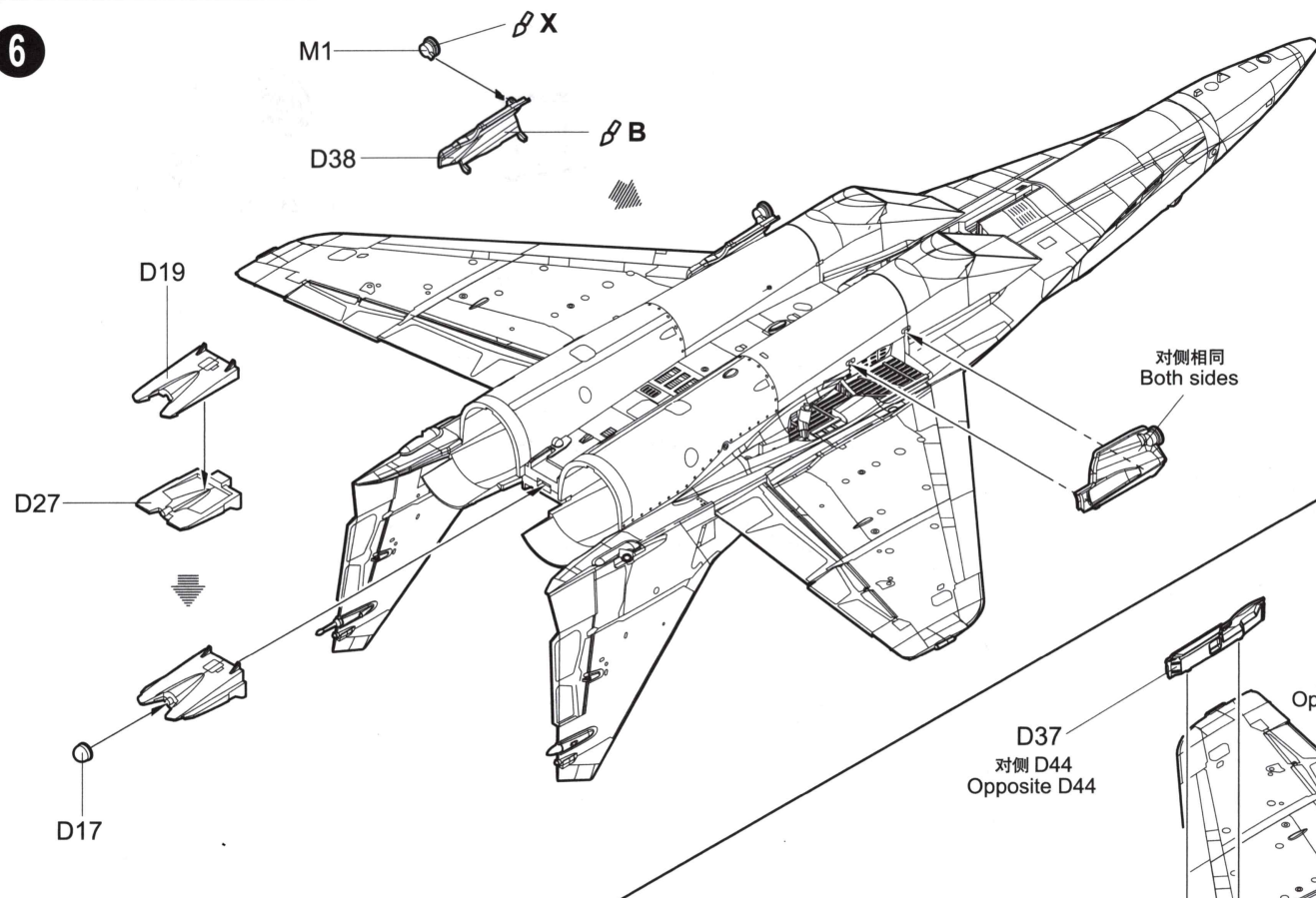

7

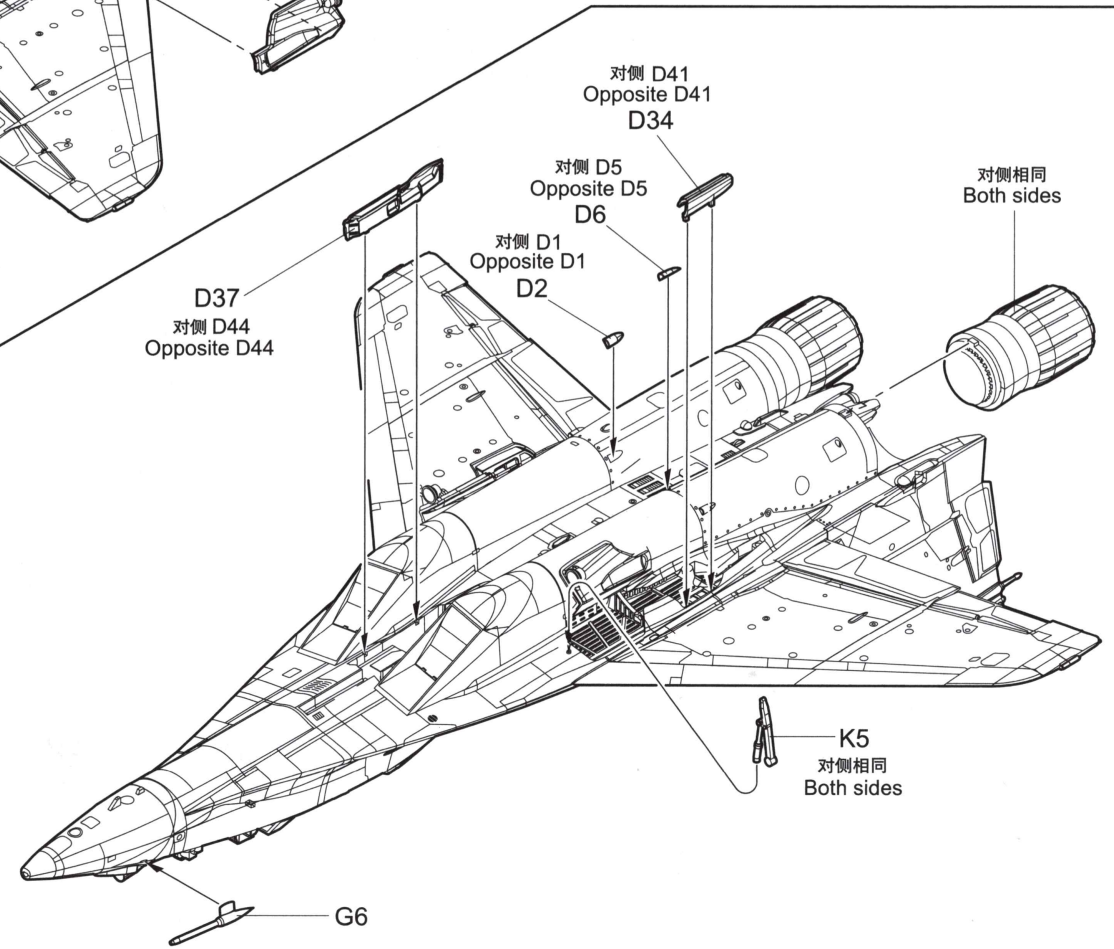
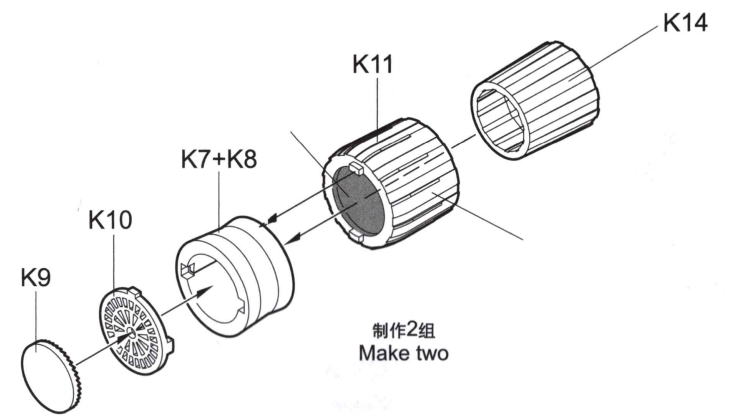

8

《右侧主起落架》
Right main undercarriage

《左侧主起落架》
Left main undercarriage

《A-A》

D8

D40

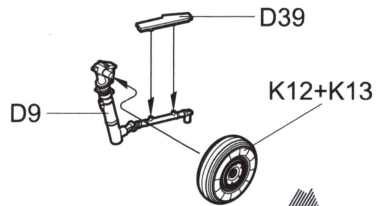

G4



D46

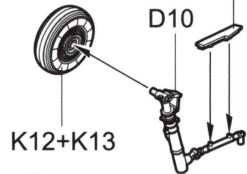

《左侧主起落架》
Left main undercarriage

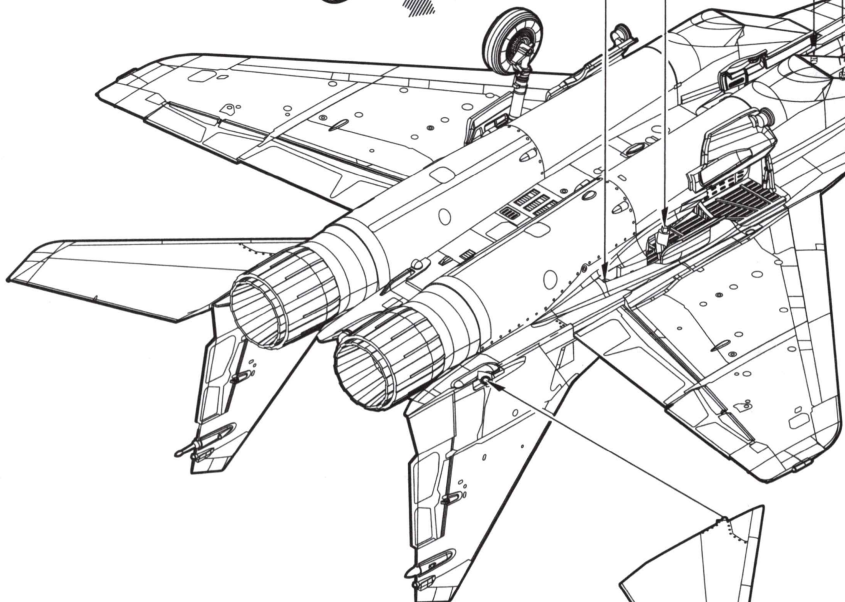

D29
对侧 D28
Opposite D28

打开状态
open

选择
Option
G12

先装
Install it first

对侧 G17
Opposite G17
G10

G7

V2
M2

《B-B》

9

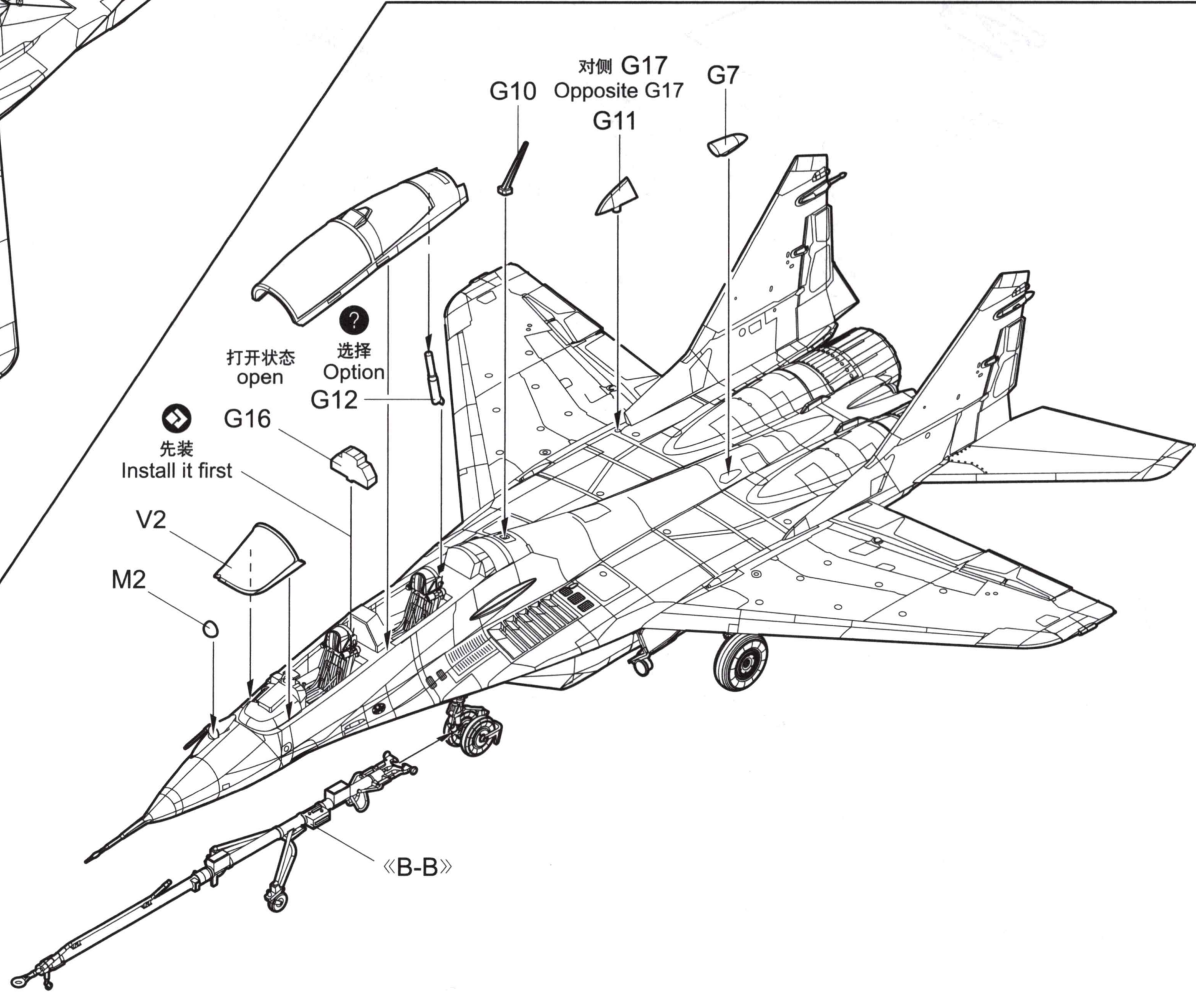
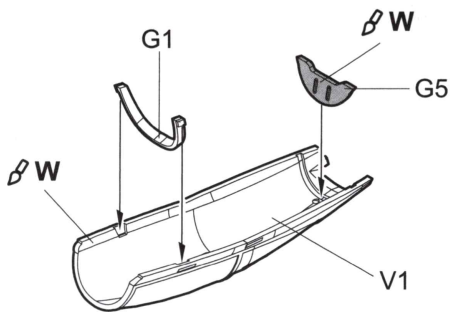

10

对侧相同
Both sides
Q4

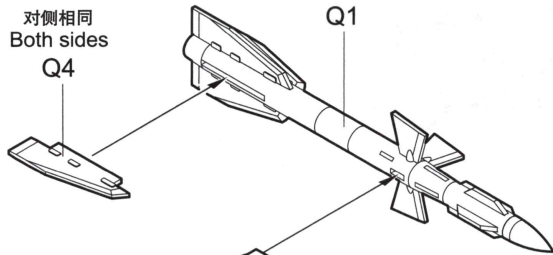

Q3
对侧相同
Both sides

R-27R

对侧相同
Both sides
Q4

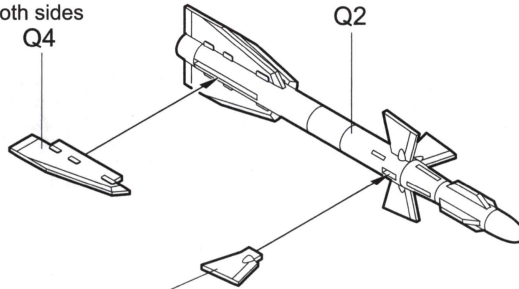

Q3
对侧相同
Both sides

R-27T

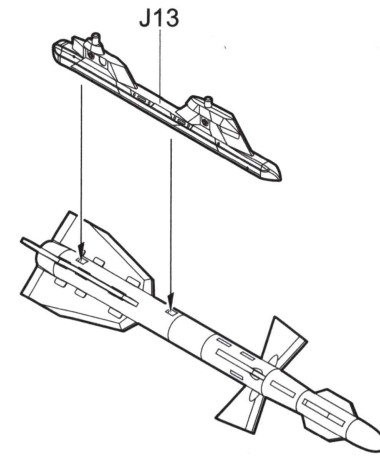

R-27R/R-27T
制作2组
Make two

11

Q5
对侧相同
Both sides

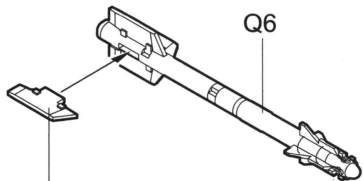

R-73E
制作2组
Make two

J12

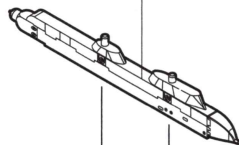

J5

?
选择
Option

12

J16

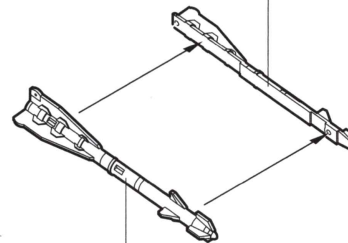

J15

J9

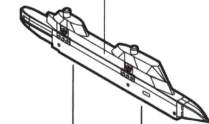

J11

?
选择
Option

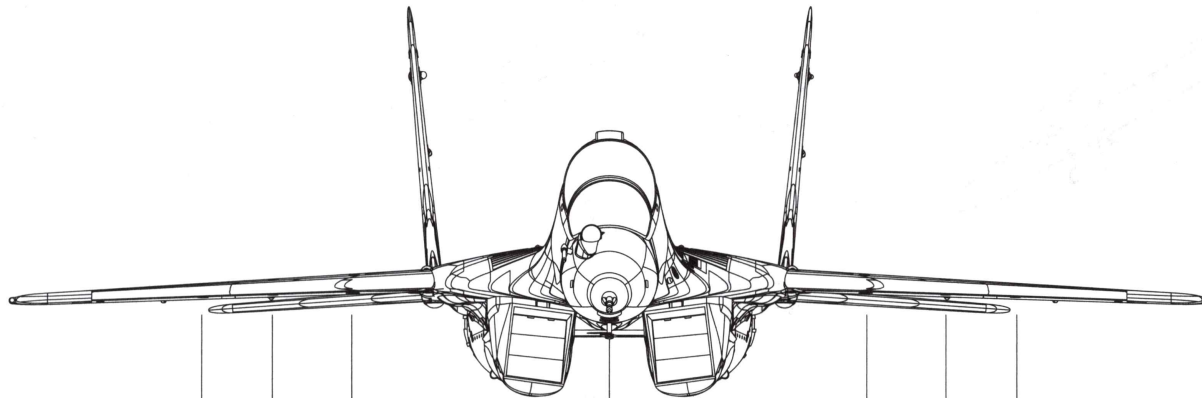

R-60
制作2组
Make two

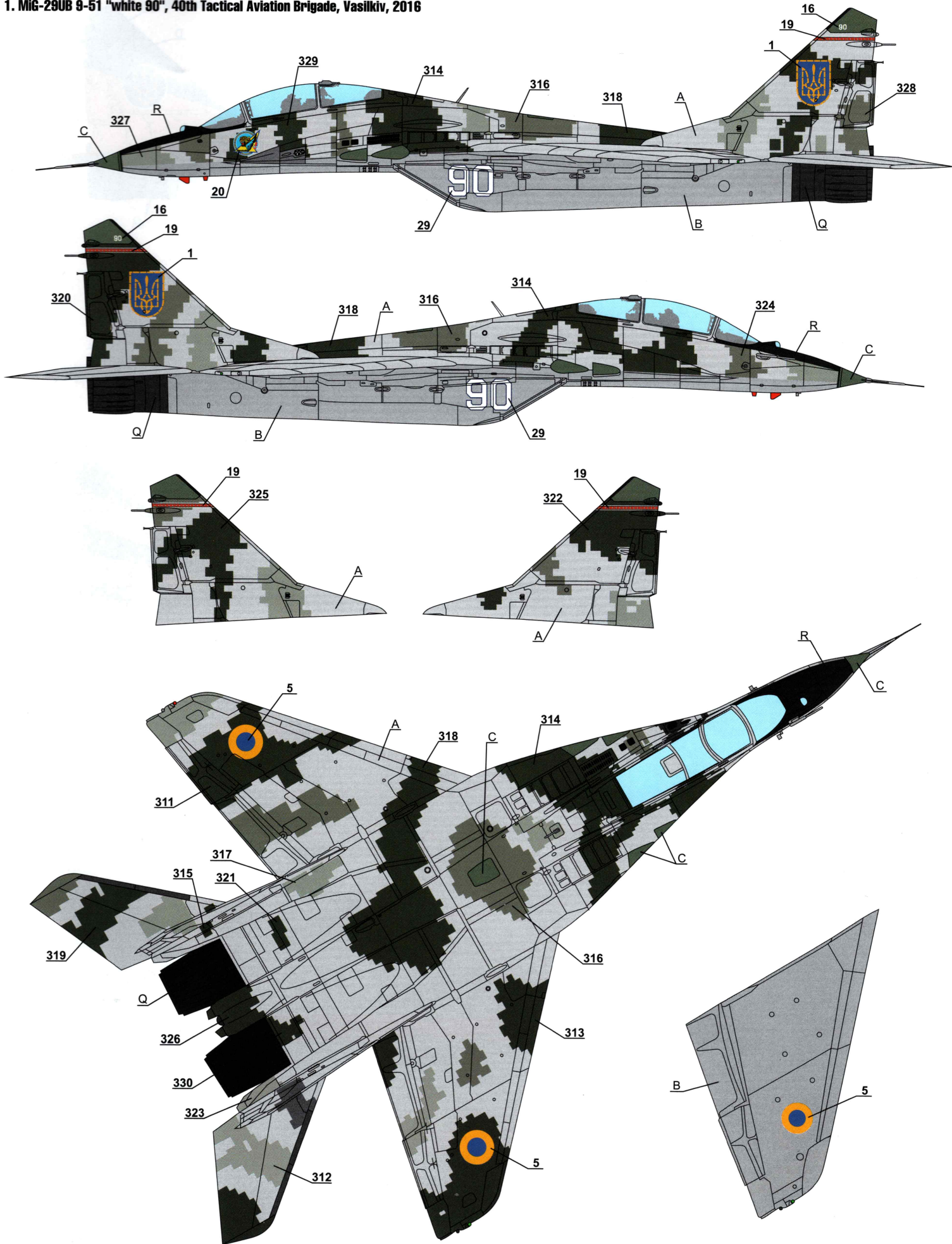

Sta.No. / Missile/Tank	1	2	3	4	5	6	7
R-27T			•		•		
R-27R			•		•		
R-60	•	•	•		•	•	•
R-73E	•	•	•		•	•	•

1. MIG-29UB 9-51 "white 90", 40th Tactical Aviation Brigade, Vasilkiv, 2016



- | | | | | |
|--|---|---|---|---|
|  |  |  |  |  |
| A | B | C | Q | R |
| HATAKA C048
Vallejo 71.121
Agate Grey | HATAKA C334
Vallejo 71.051
Silver Grey | HATAKA C335
Vallejo 71.259
Mouse Grey | HATAKA A078
Vallejo 77.713
Jet Exhaust | HATAKA A041
Vallejo 71.057
Black |

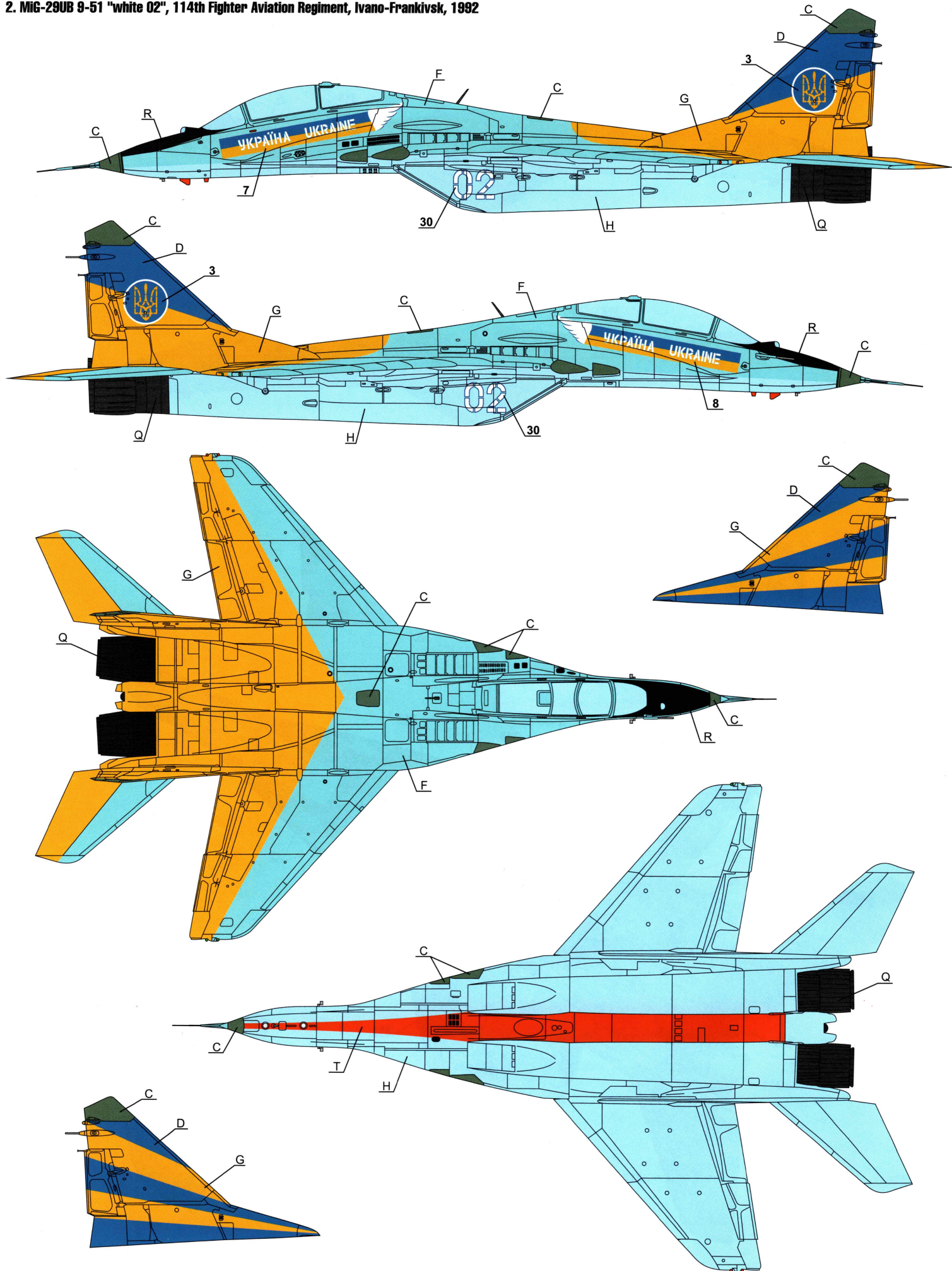

- | | | | | | | | |
|--|---|---|---|---|--|---|---|
|  |  |  |  |  |  |  |  |
| HATAKA C335
Vallejo 71.259
Mouse Grey | HATAKA A220
Vallejo 70.809
Traffic Blue | HATAKA A066
Vallejo 71.078
Orange Yellow | HATAKA A321
Vallejo 70.841
Light Sky Blue | HATAKA A229
Vallejo 70.961
Light Blue | HATAKA A078
Vallejo 77.713
Jet Exhaust | HATAKA A041
Vallejo 71.057
Black | HATAKA A276
Vallejo 71.003
Red |

3. MiG-29UB 9-51 "blue 51", 9th Tactical Aviation Brigade, Ozerne (Zhitomir), 2007

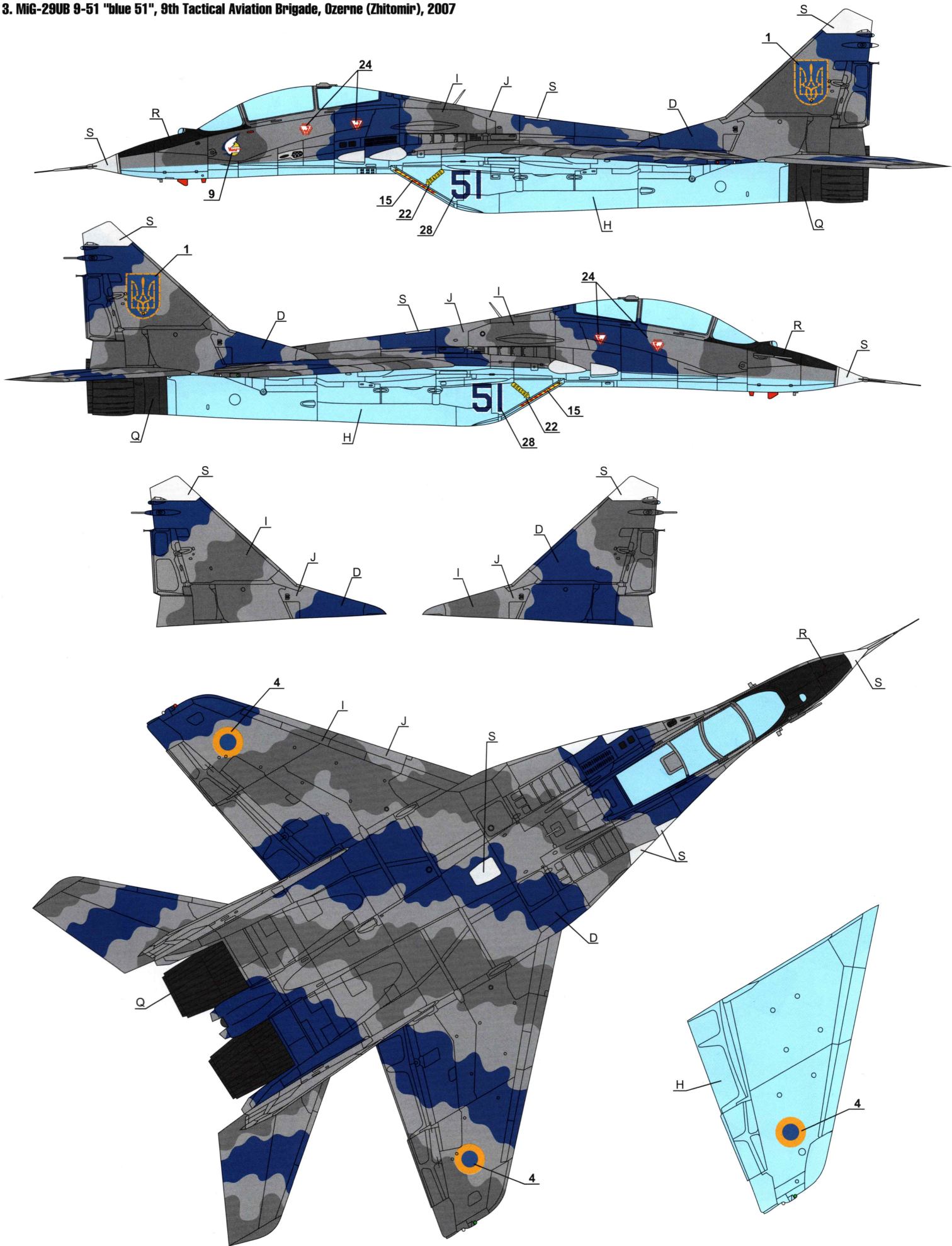

- | | | | | | | |
|---|--|--|--|---|--|--|
|  D |  H |  I |  J |  Q |  R |  S |
| HATAKA A220
Vallejo 70.809
Traffic Blue | HATAKA A229
Vallejo 70.961
Light Blue | HATAKA C249
Vallejo 71.047
Dusty Grey | HATAKA C334
Vallejo 71.050
Window Grey | HATAKA A078
Vallejo 77.713
Jet Exhaust | HATAKA A041
Vallejo 71.057
Black | HATAKA A101
Vallejo 71.001
Satin White |

4. MiG-29UB 9-51 "blue 61", 642nd Guards Fighter Aviation Regiment, Martynivka, 2002

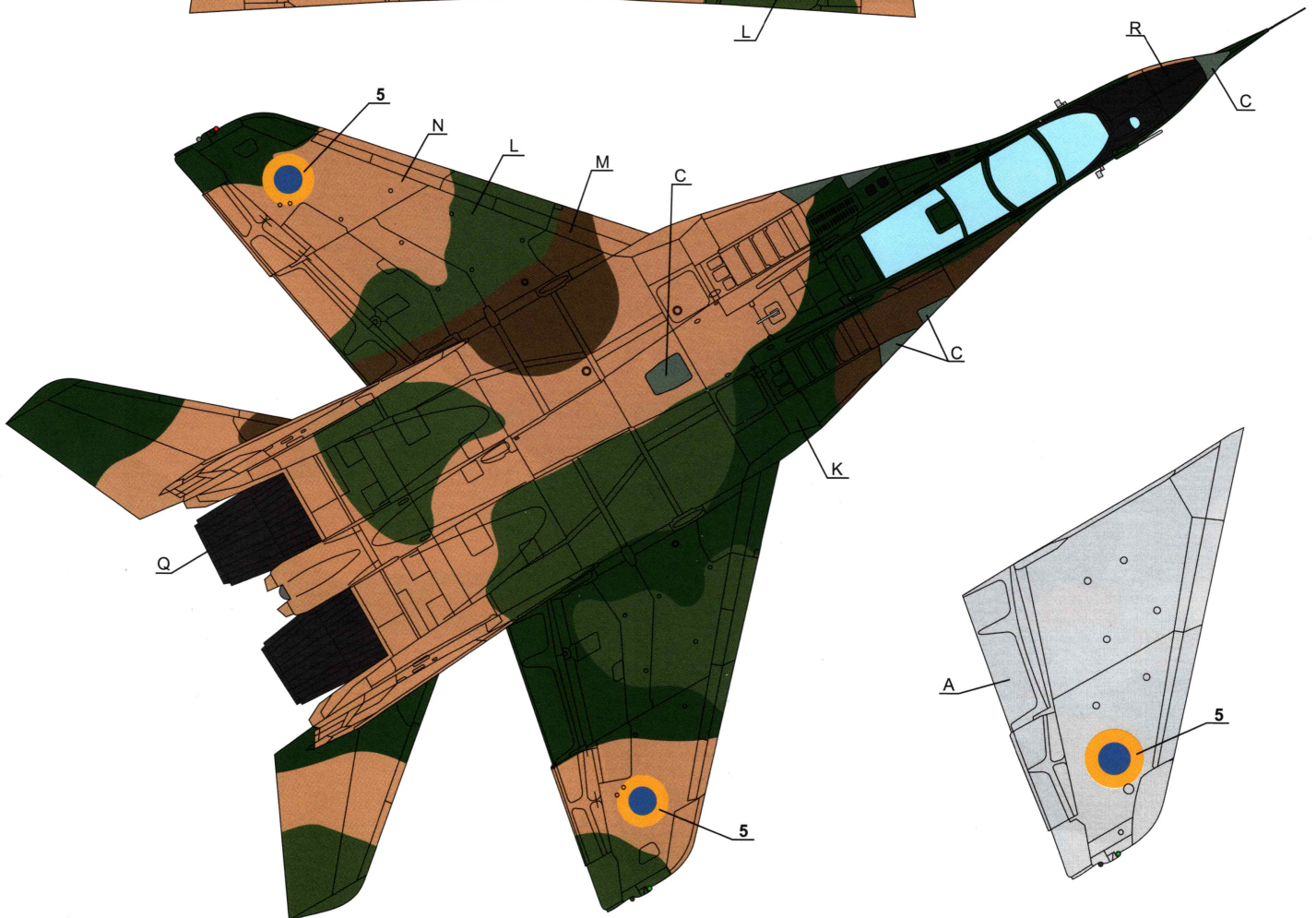
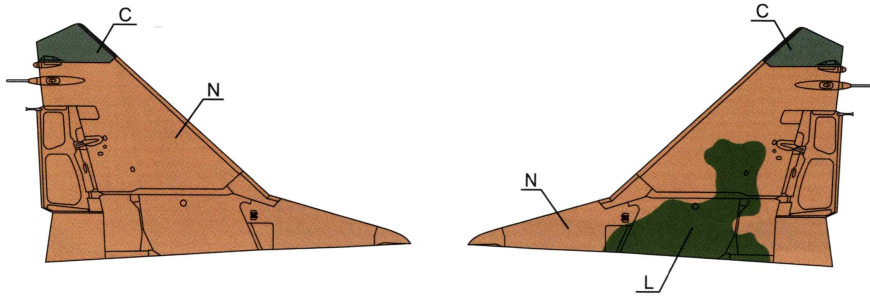
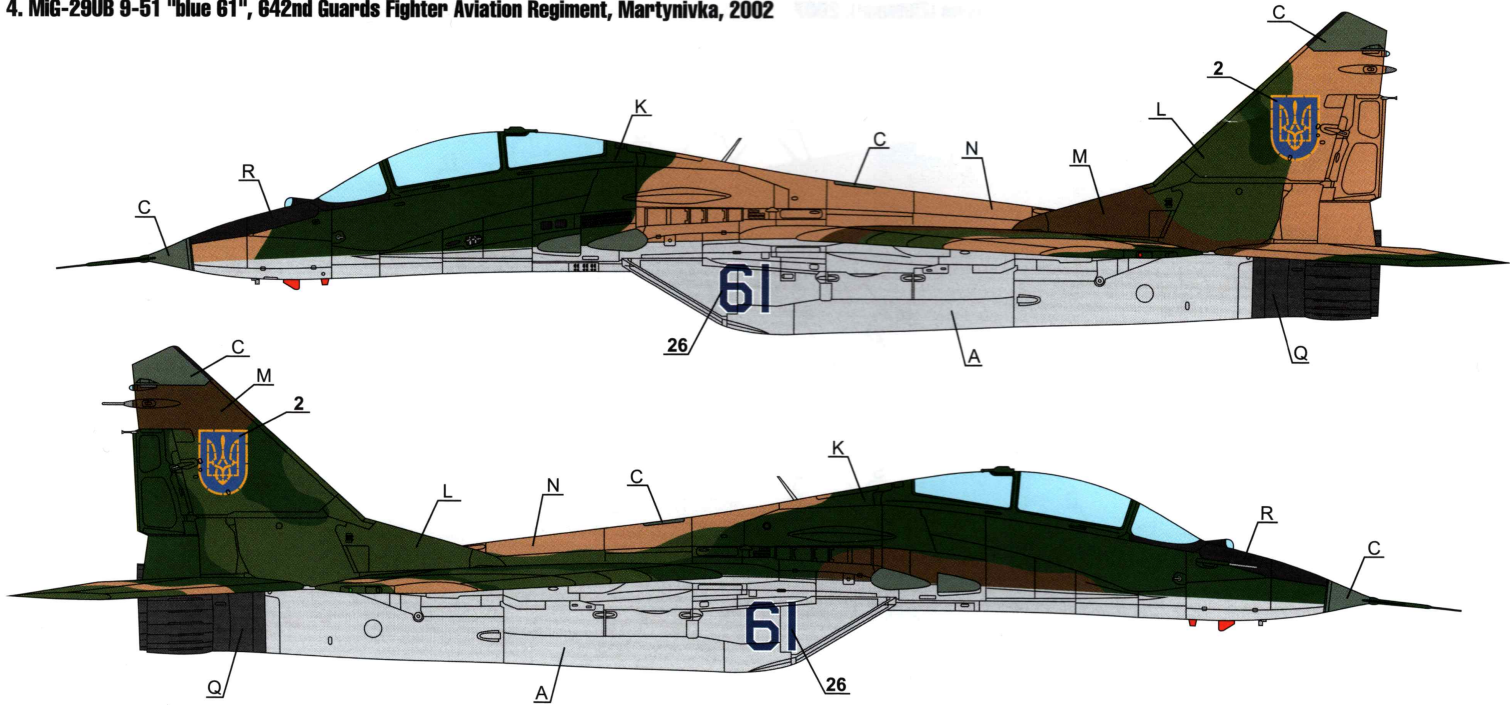

							
A	C	K	L	M	N	Q	R
HATAKA C048 Vallejo 71.121 Agate Grey	HATAKA C335 Vallejo 71.259 Mouse Grey	HATAKA A019 Vallejo 71.347 Turquoise Green	HATAKA A091 Vallejo 70.968 Leaf Green	HATAKA A087 Vallejo 70.859 Black Red	HATAKA A306 Vallejo 70.804 Beige Red	HATAKA A078 Vallejo 77.713 Jet Exhaust	HATAKA A041 Vallejo 71.057 Black

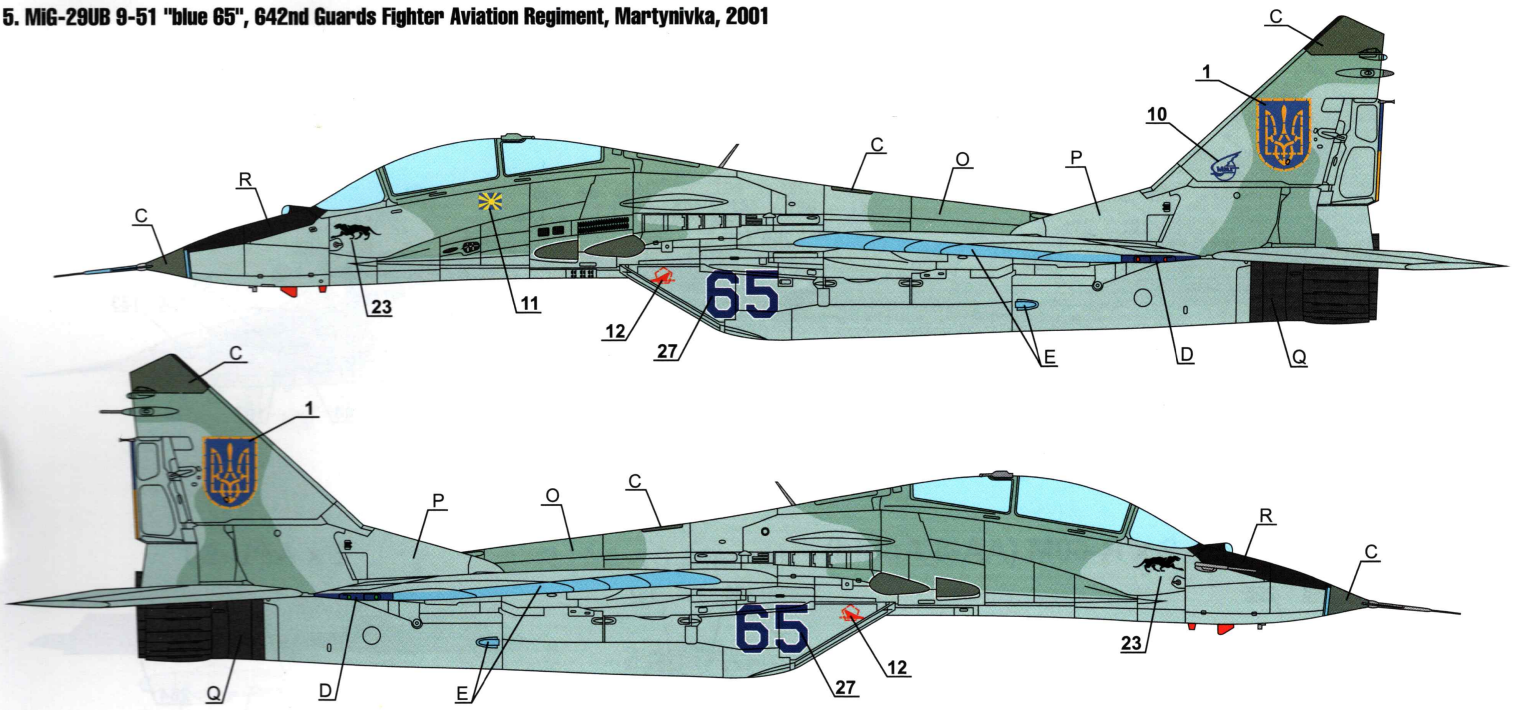

Left stabilizer bottom view

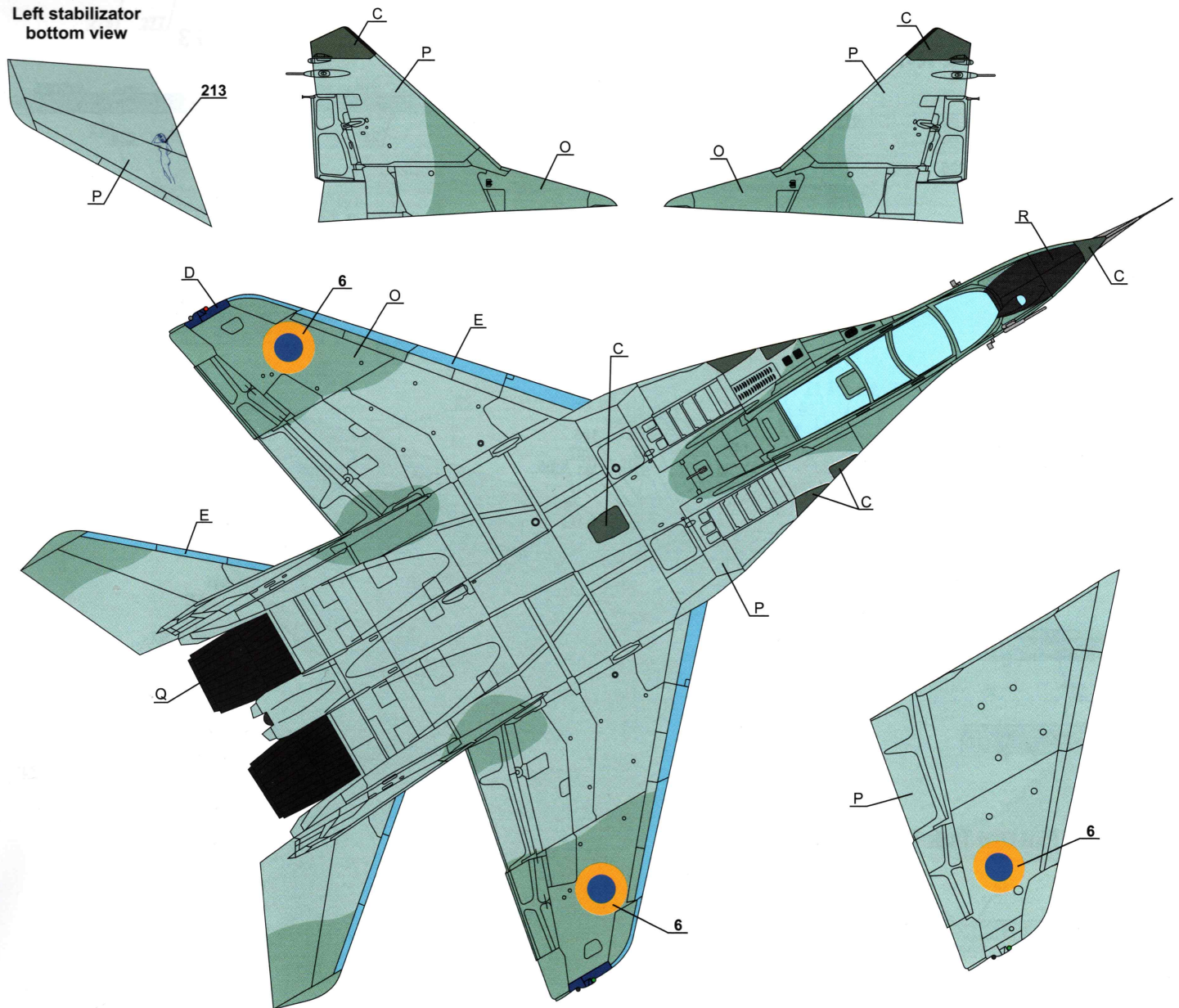

- | | | | | | | |
|--|---|---|---|---|---|---|
|   |   |   |   |   |   |   |
| HATAKA C335
Vallejo 71.259
Mouse Grey | HATAKA A220
Vallejo 70.809
Traffic Blue | HATAKA A320
Vallejo 70.844
Sky Blue | HATAKA A709
Vallejo 71.340
Flat Grey Green | HATAKA A044
Vallejo 71.277
Dark Gull Gray | HATAKA A078
Vallejo 77.713
Jet Exhaust | HATAKA A041
Vallejo 71.057
Black |

Stencils application scheme

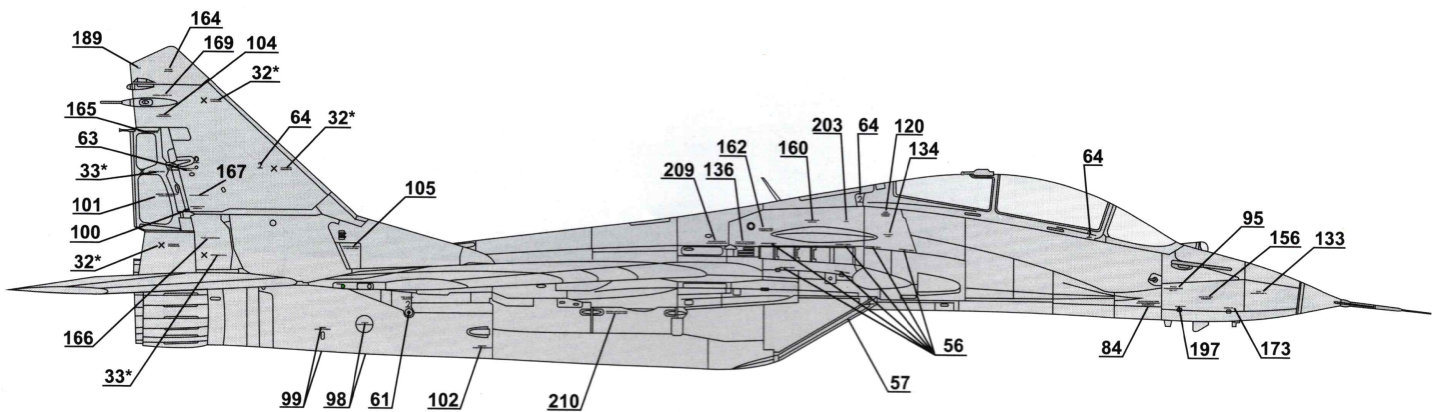

2 x R-60M (AA-8 Aphid)

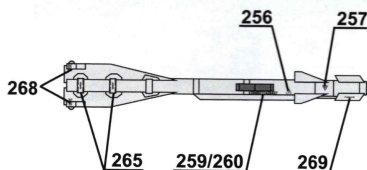
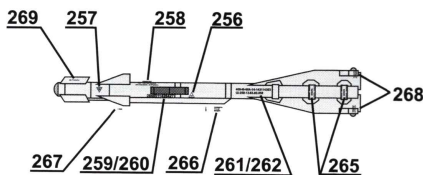

2 x APU-60

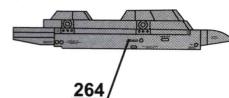
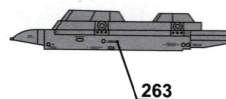

2 x R-73 (AA-11 Archer)

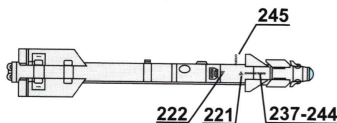
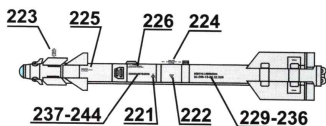

2 x APU-73

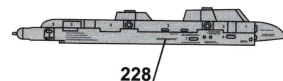
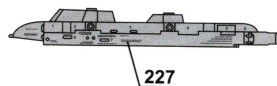

PFB Fuel Tank 1500 L

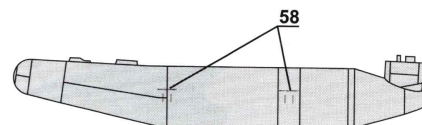
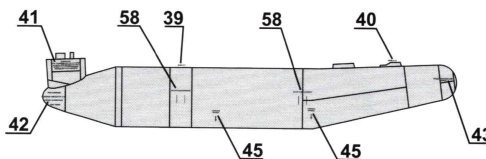

2 x PKB Fuel Tank 1150 L

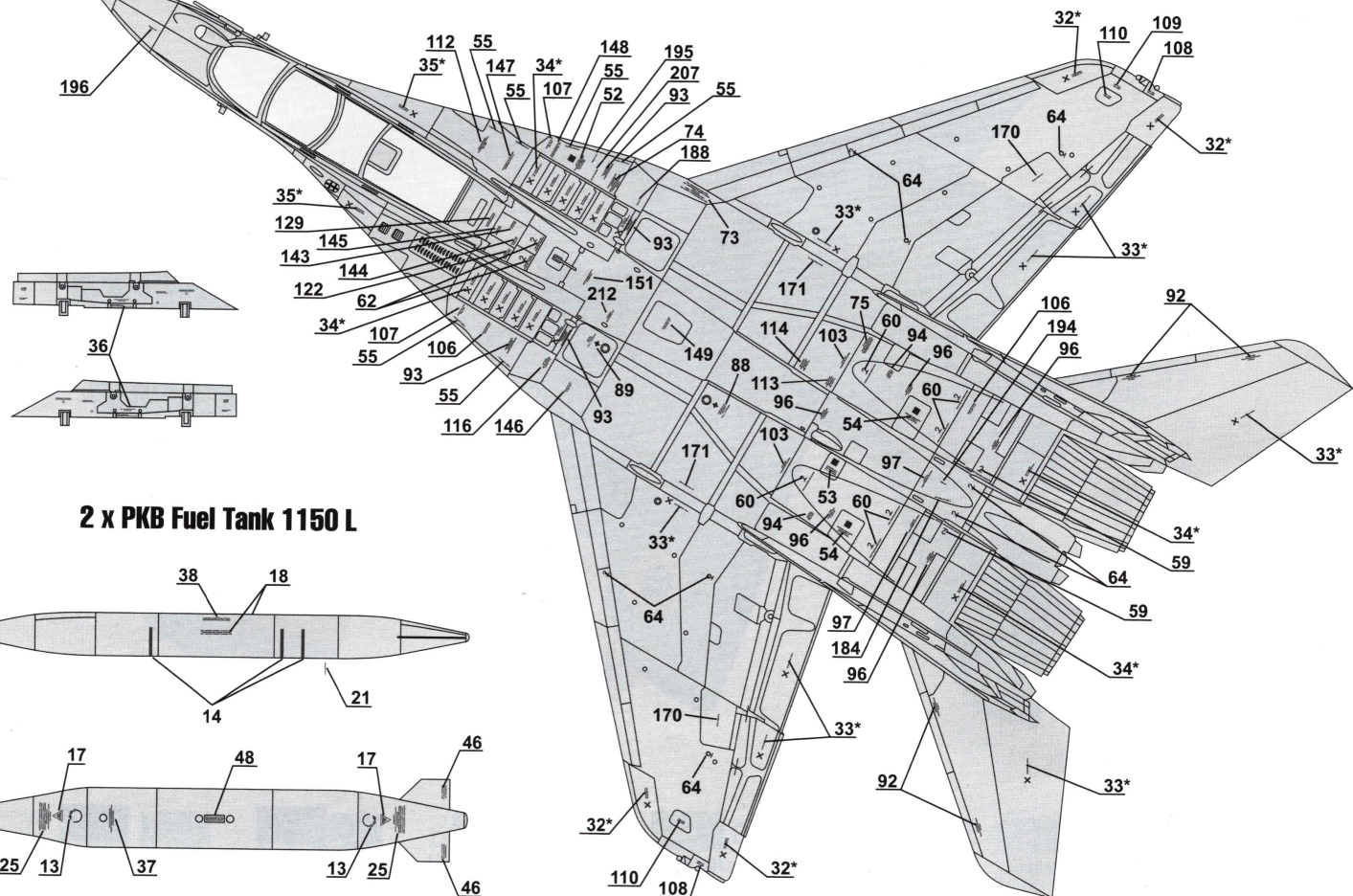
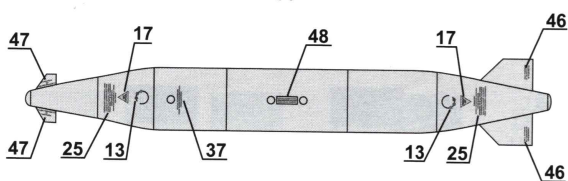
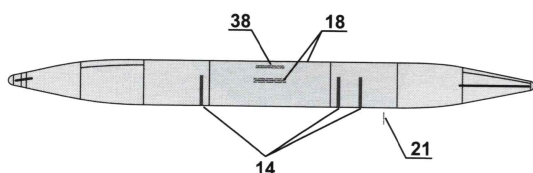

Stencils application scheme

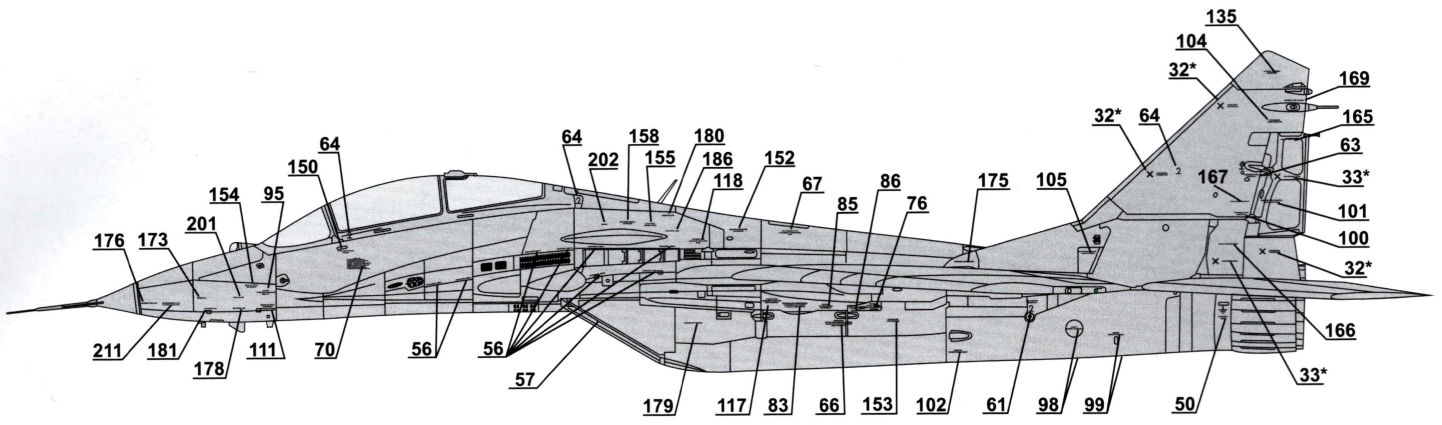

2 x R-27R (AA-10 Alamo)

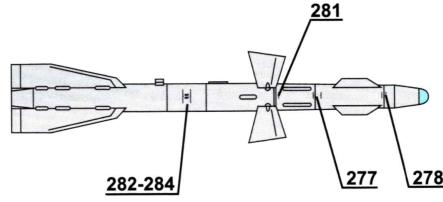
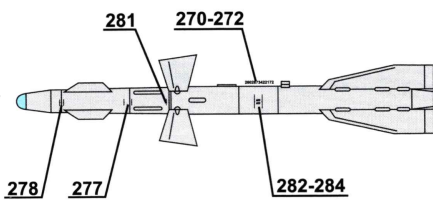

2 x APU-470

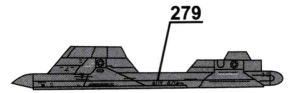

2 x R-27T (AA-10 Alamo)

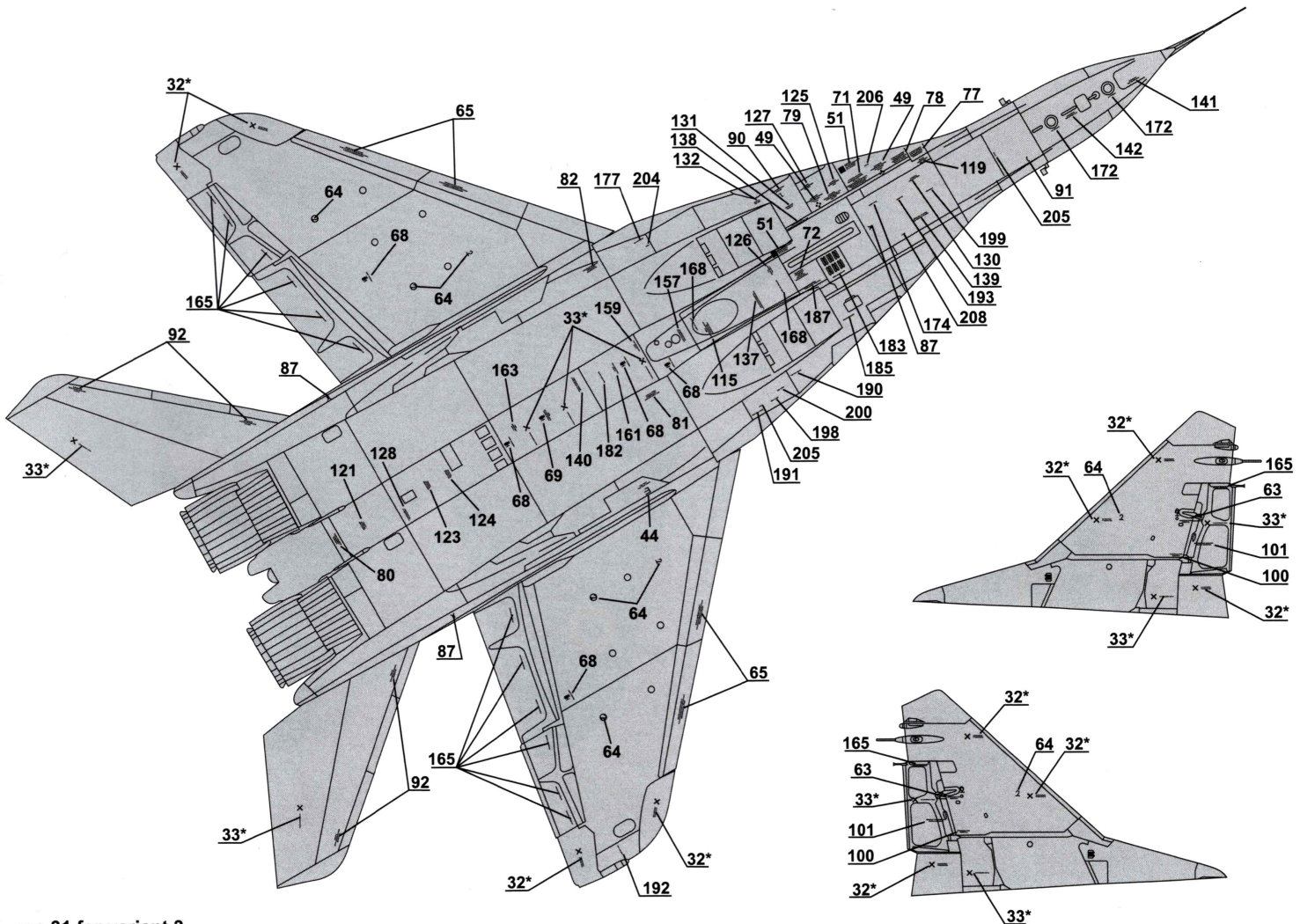
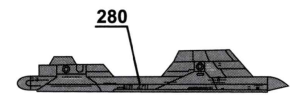
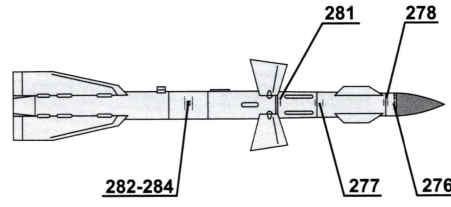
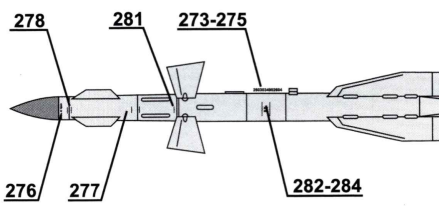

* - use 31 for variant 3

Ukrainian MiG-29UB (9.51)

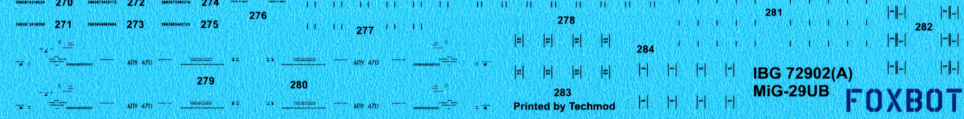
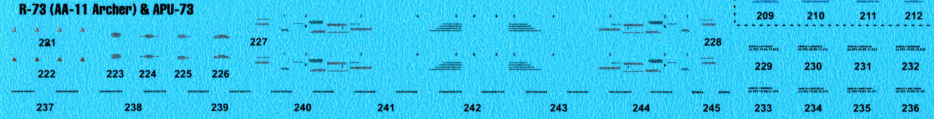
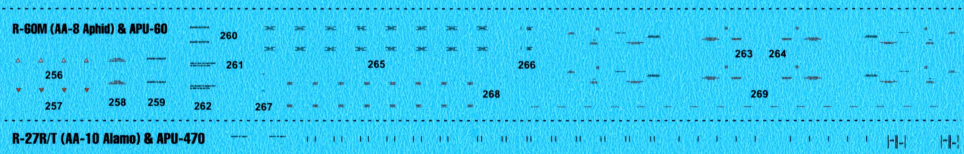
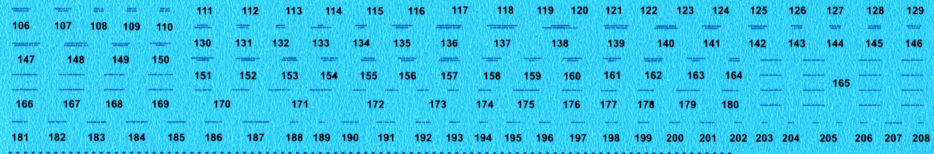
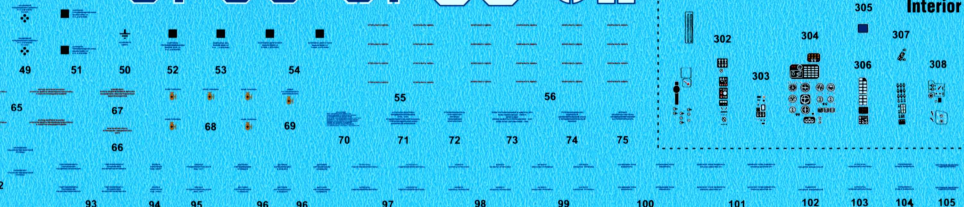
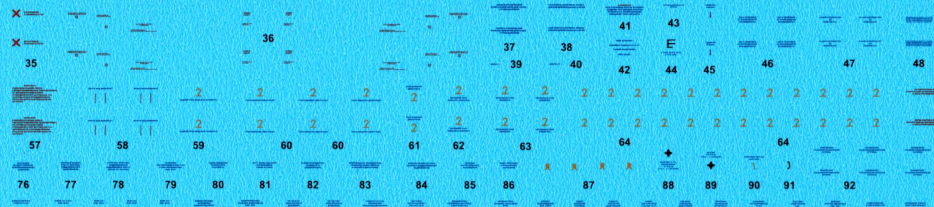
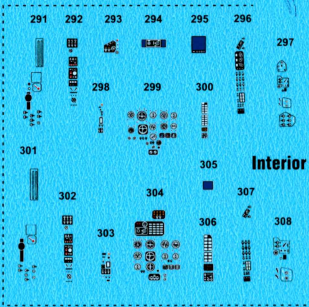
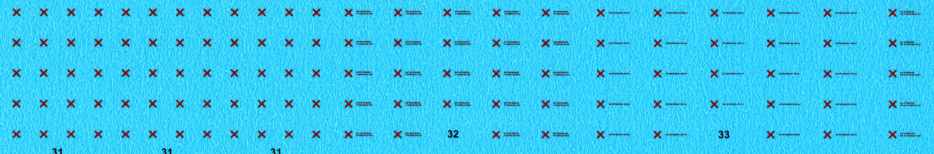
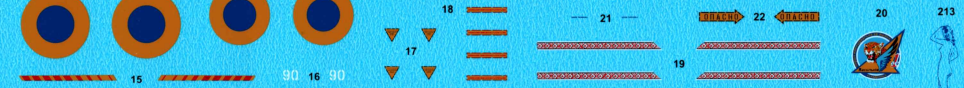
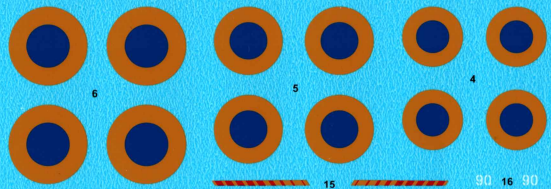
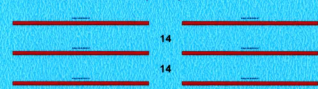

IBG 72902(A)
MiG-29UB
FOXBOT
Printed by Techmod

311

313

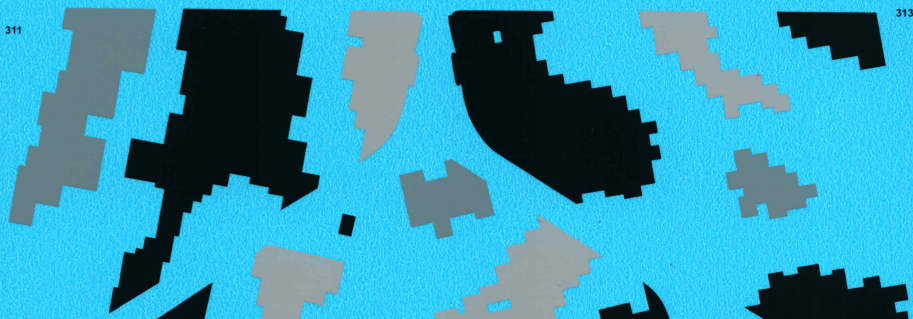

319

312

314

318

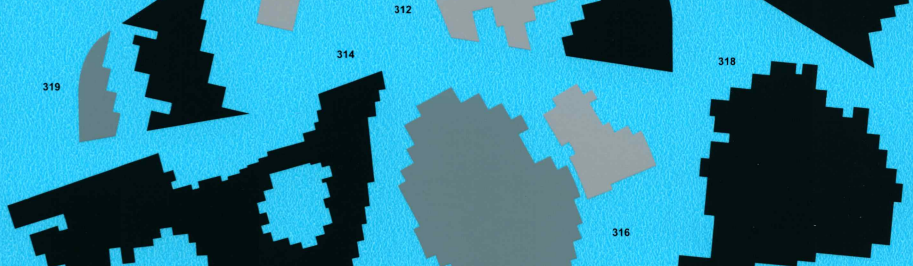

316

323

322

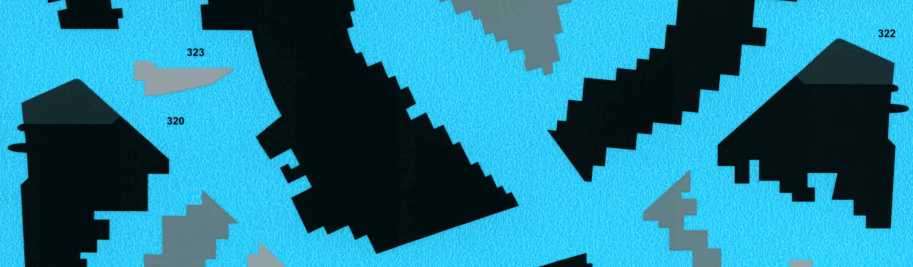

320

321

315

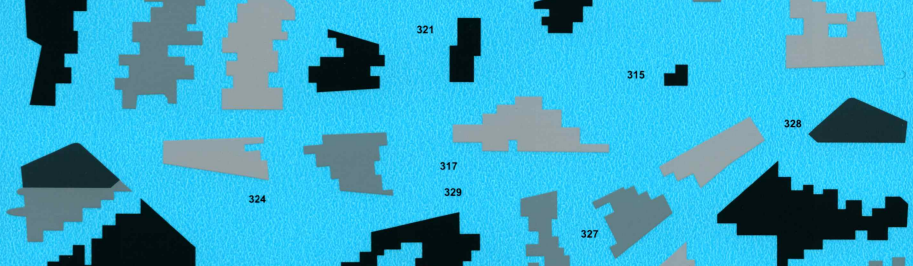

328

324

317

329

327

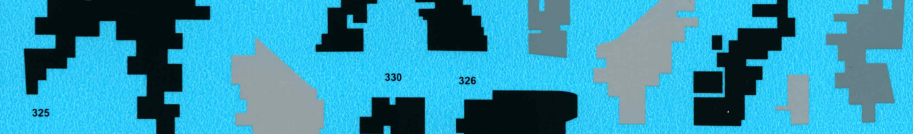

325

330

326