

THE HELLCAT

F6F-5 war & postwar service

ACD 48020

1/48 decal set



UNITED STATES



FRANCE



URUGUAY

1/48 decal set - 9 marking options

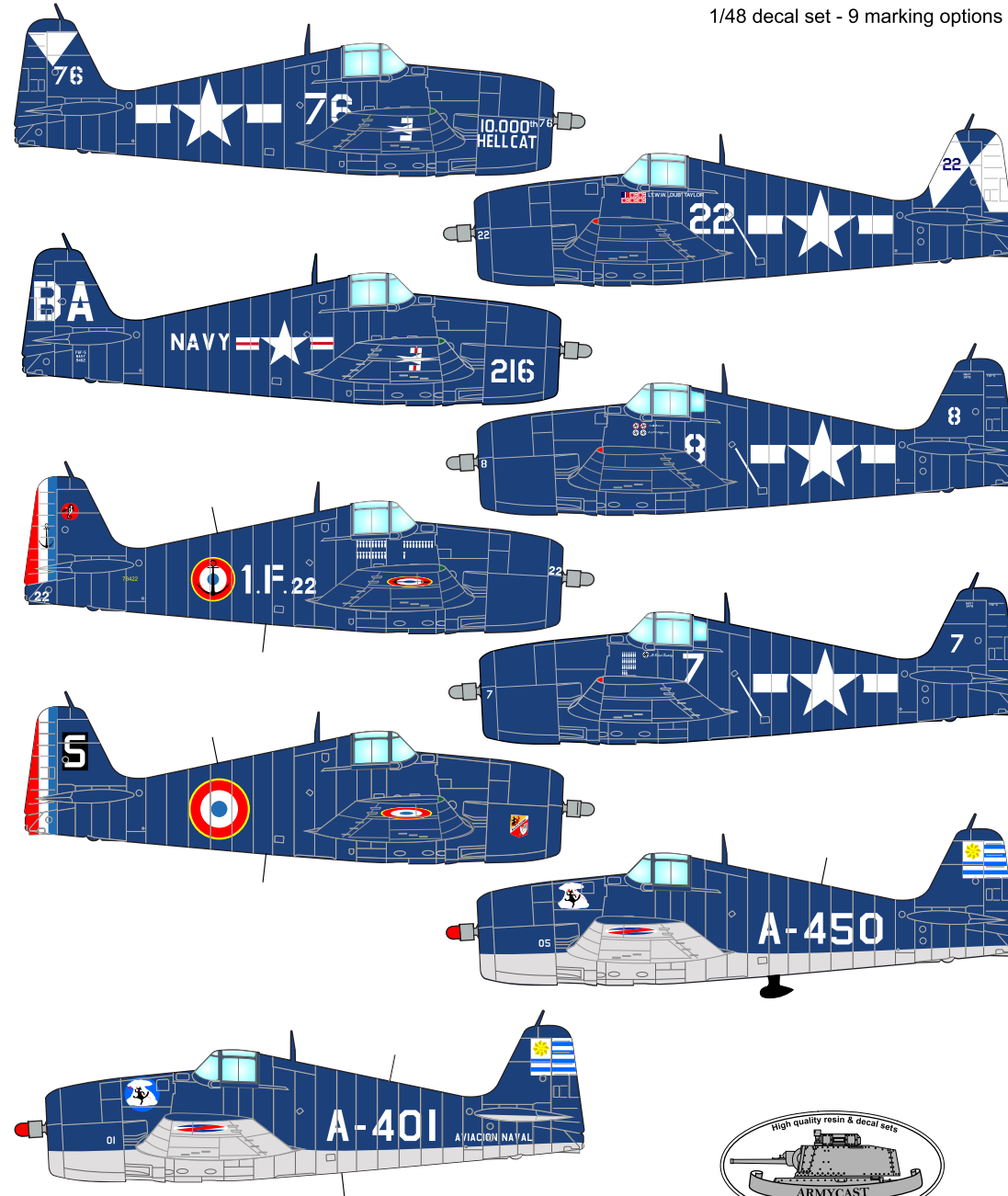

Used colours:

			GUNZE SANGYO Mr. COLOR
A		GLOSS SEA BLUE	FS 15042 365 or 14
B		RED	3
C		MATT BLACK	33
D		OFF WHITE	69
E		SILVER	8

Recommended kit: **Eduard**
Hobby boss

www.armycast.cz

Printed in the EU
© Armycast, 2017

www.armycast.cz

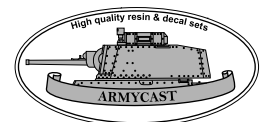

© Armycast, 2017

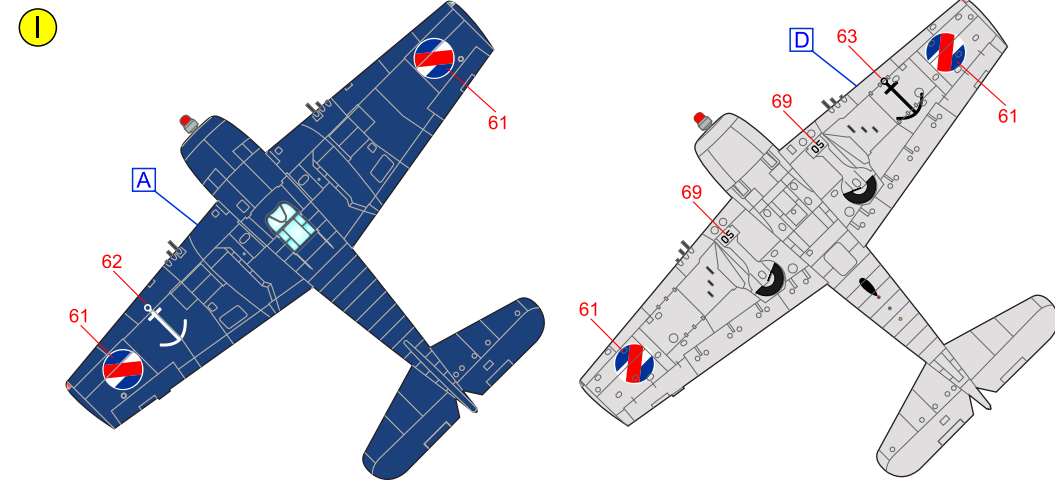
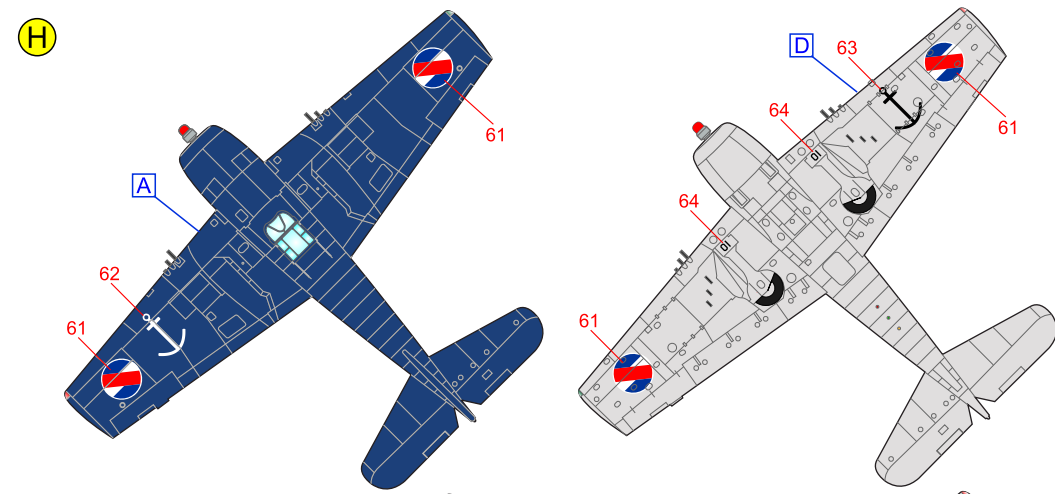
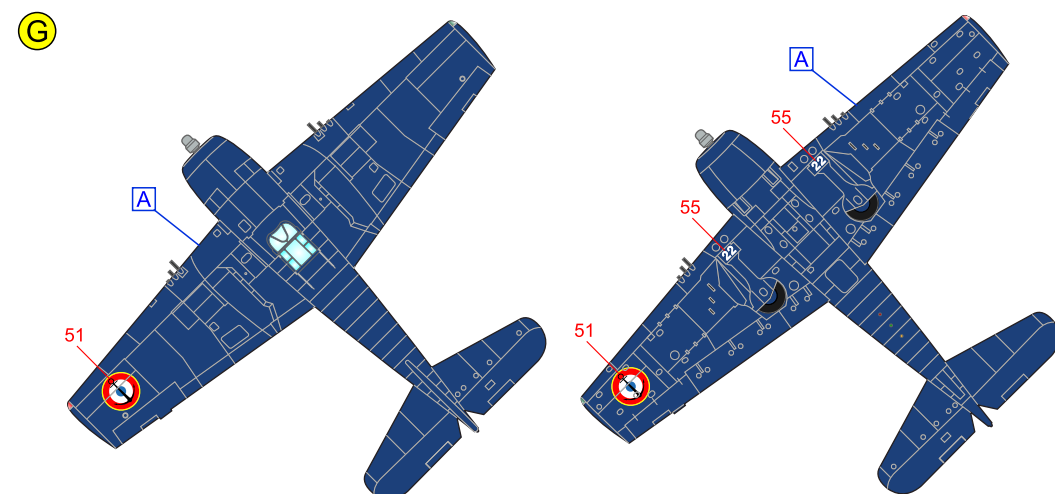
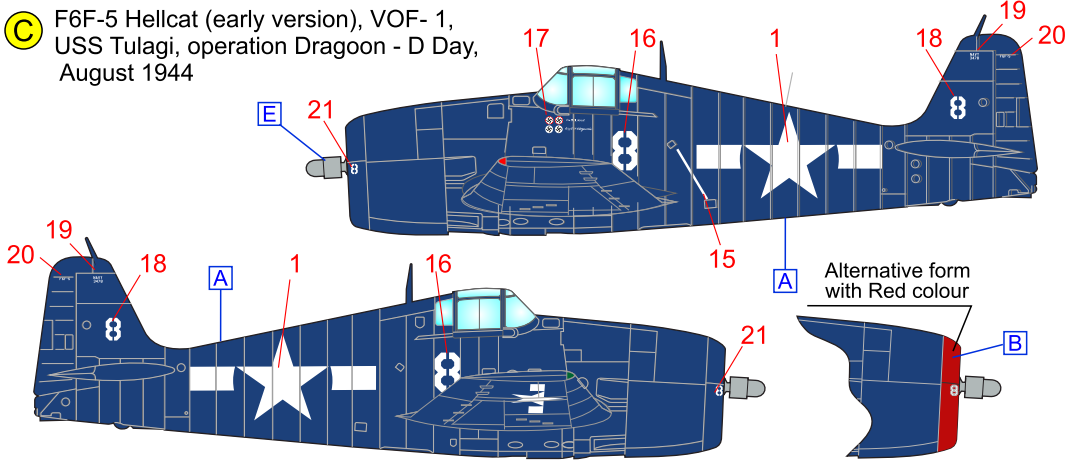
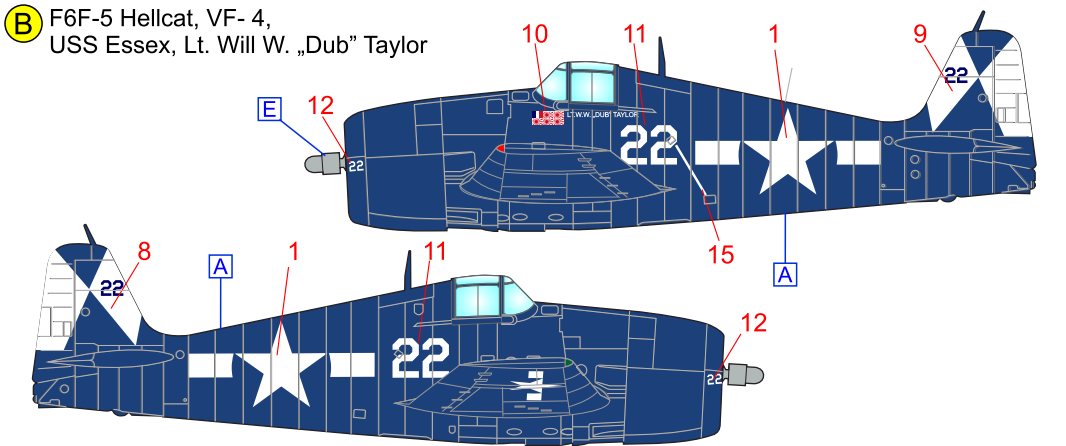
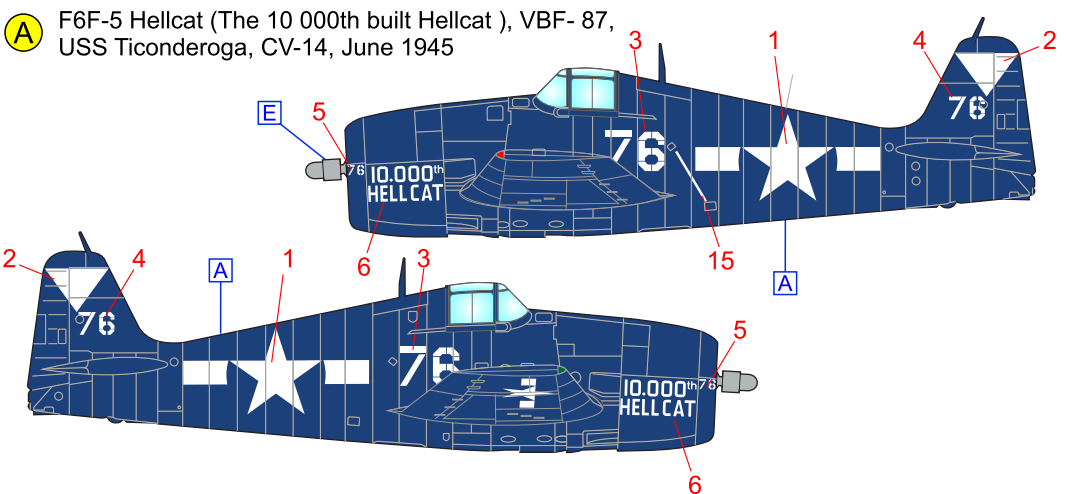

On 21 August pilots VOF-1 shoot down three Ju-52 near Marseille. Two planes credited to Lieut. (jg) Eduard W. Olszewski, on this Hellcat. Other two kills painted on this Hellcat belong Ens. Alfred R. Wood. Totally score VOF-1 during operation Dragoon was 6 Luftwaffe planes.

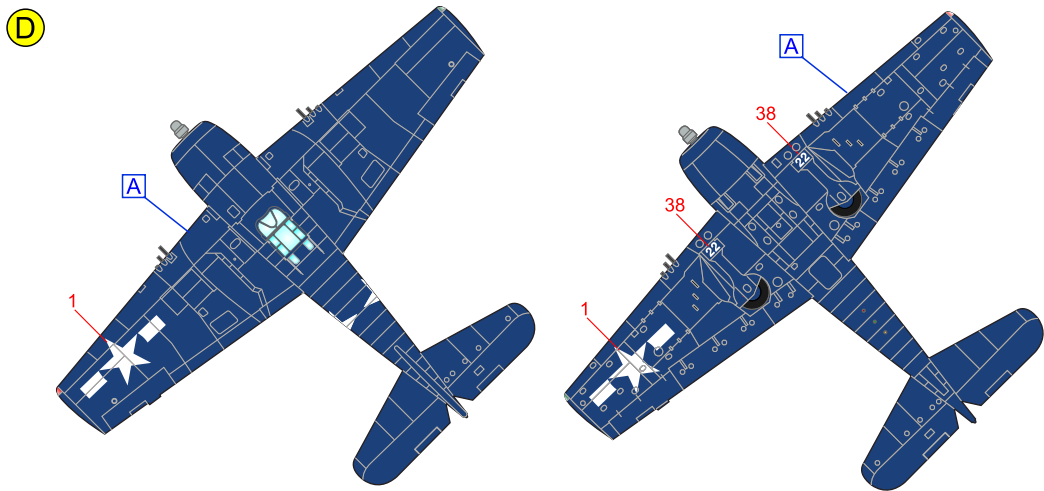

D F6F-5 Hellcat (early version), LTN Robert Benteley, VOF- 1, USS Tulagi, operation Dragoon - D Day, August 1944

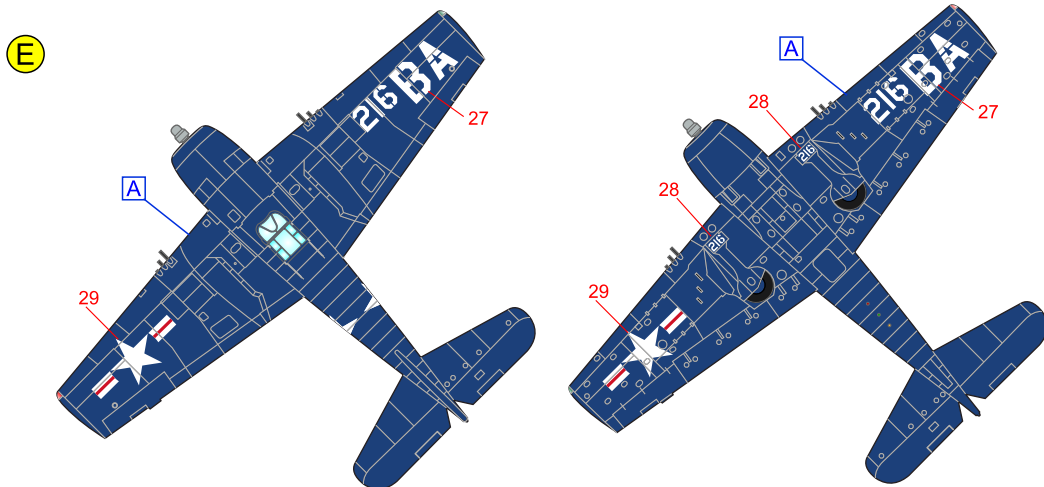
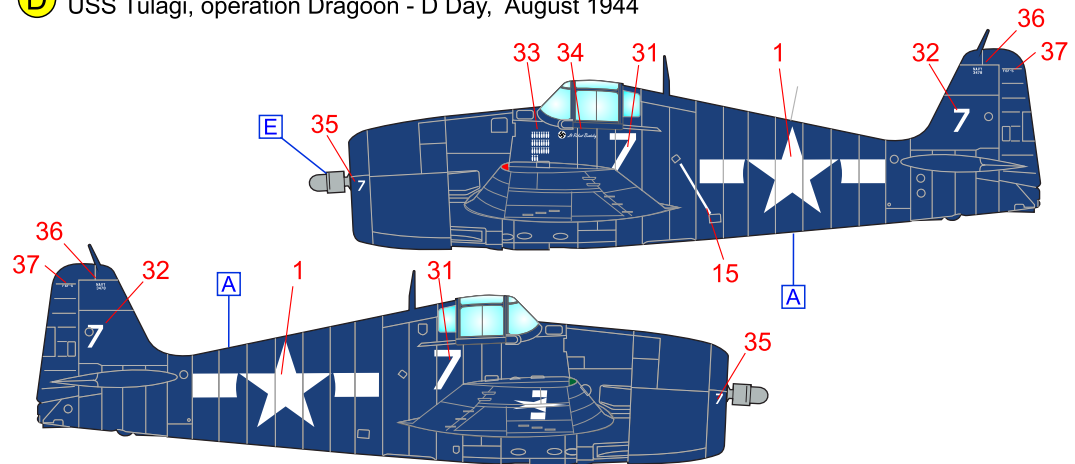

E F6F-5 Hellcat , „White 216”, CVL-26, USS Monterey, 1953

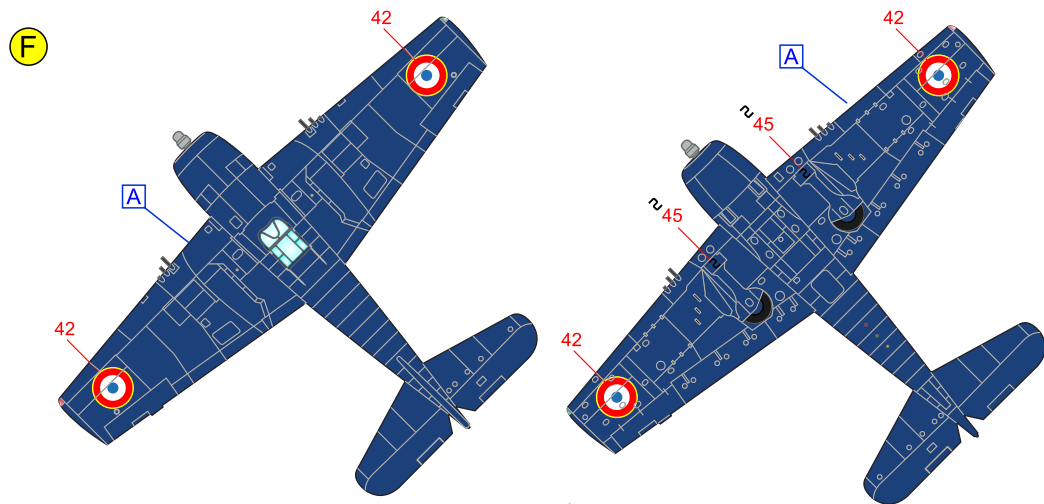
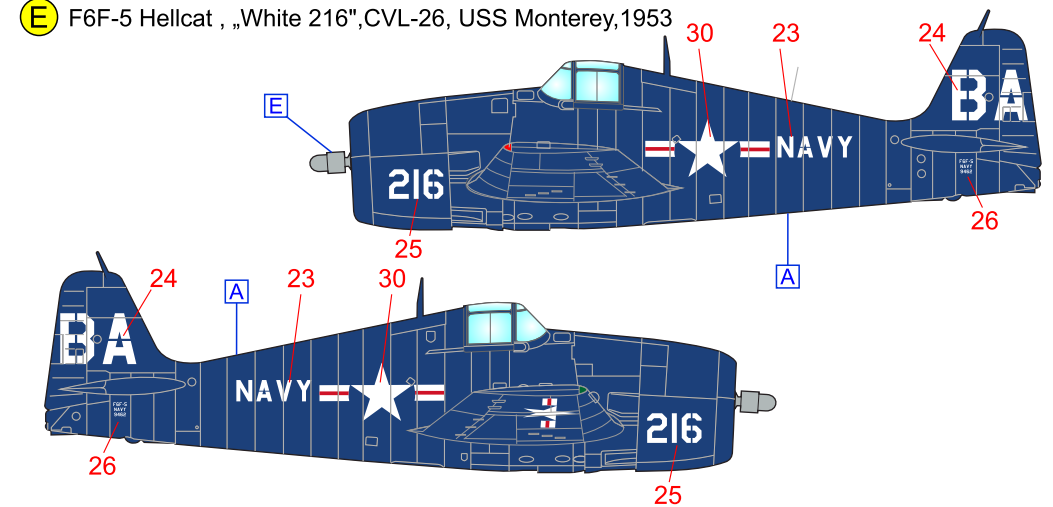

F F6F-5 Hellcat, „S”, GC II/9 Auvergne, Armée de l’Air, Tan Son Nhut AB (Vietnam) 1952

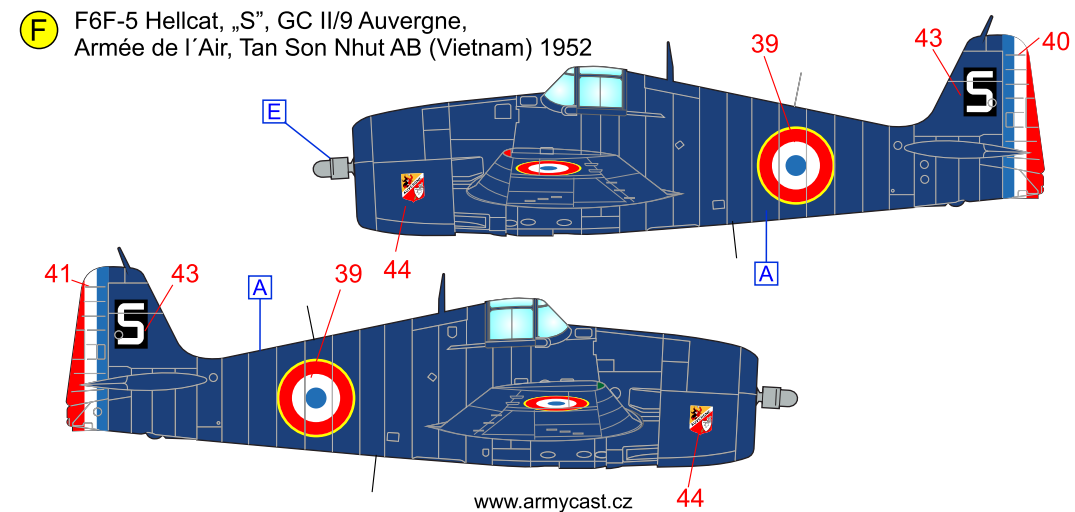

G F6F-5 Hellcat, Flottille 1F, Aeronavale, Indochine 1951

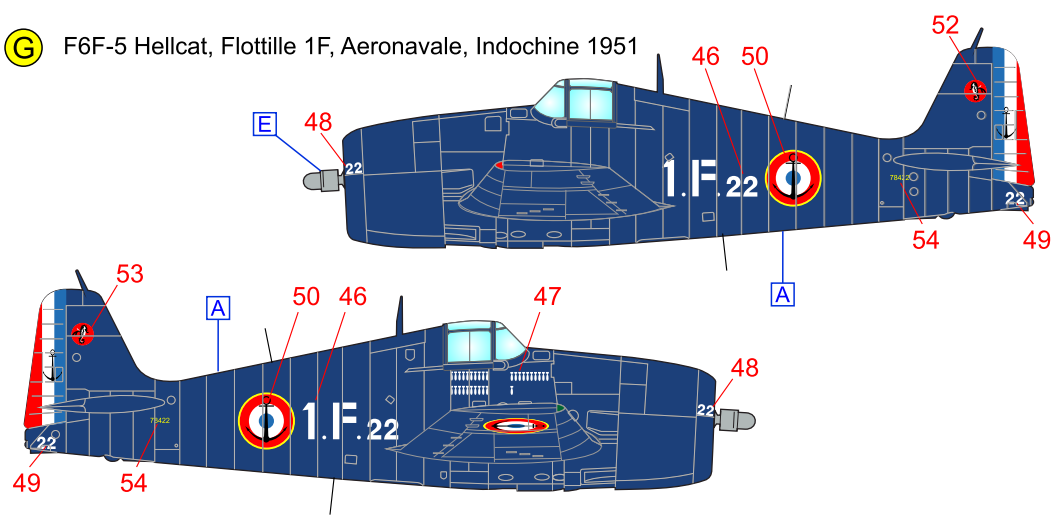

A

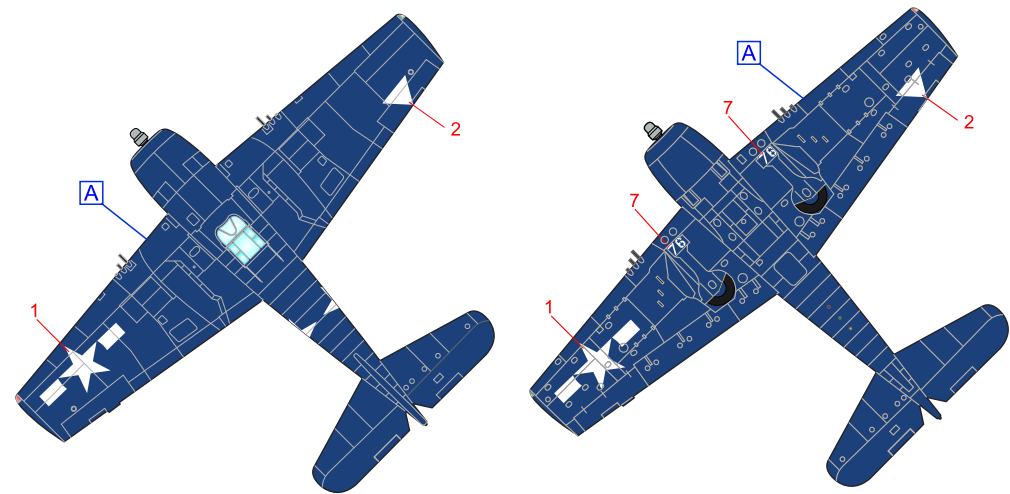

H F6F-5 Hellcat, Uruguay Aviacion Naval, 1952-1960

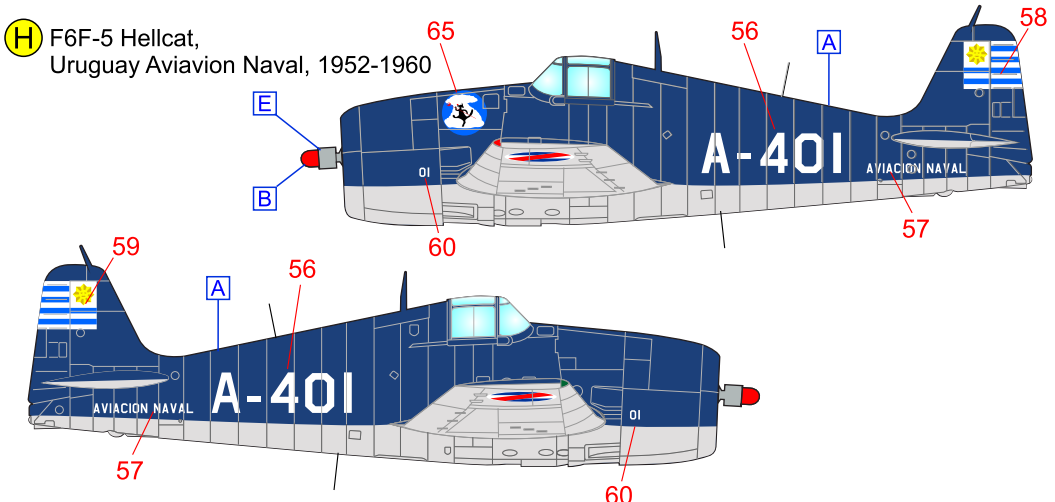

B

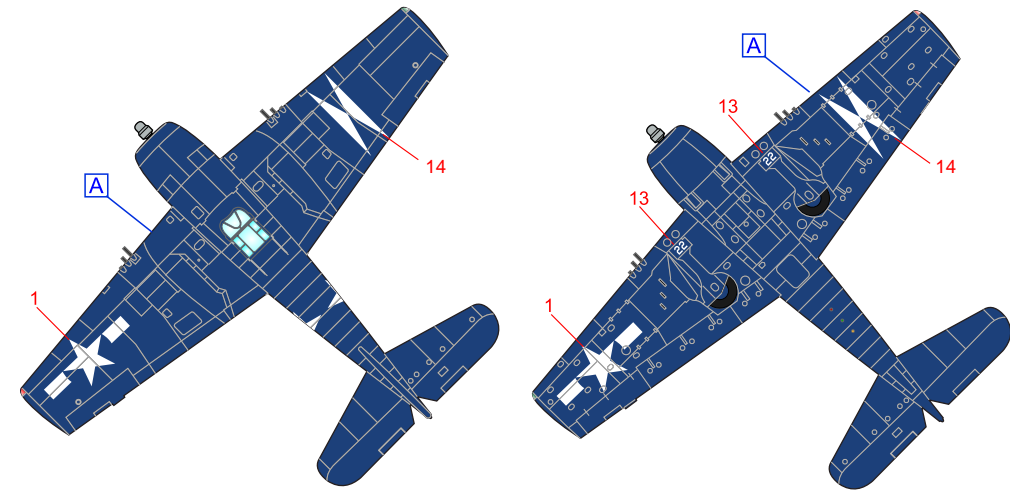

I F6F-5 Hellcat, Uruguay Aviacion Naval, 1952-1960

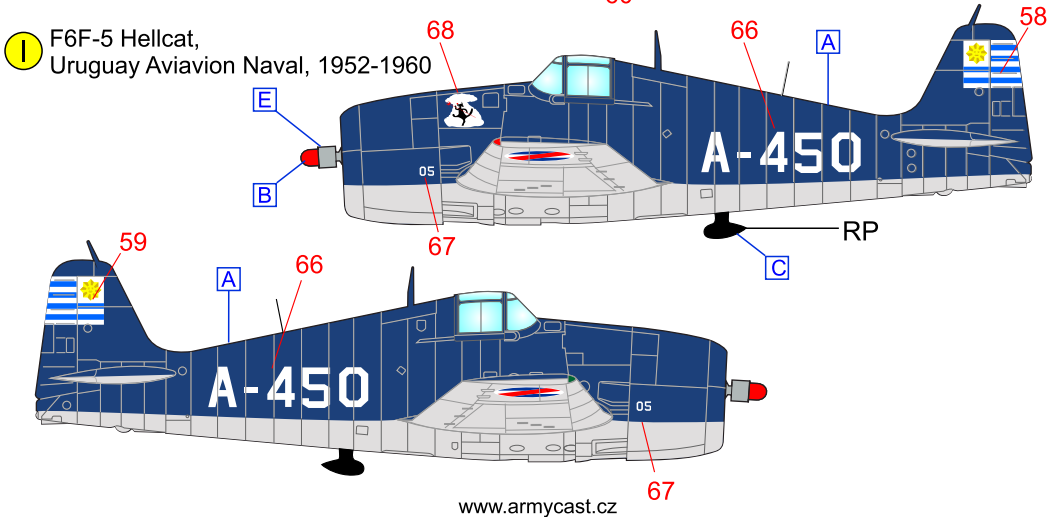

C

