

1/35 **Wiesel 1 機砲改套** 3D printed kit
Armored Weapons Carrier

TR-35005 RH-202 MaschinenKanone conversion kit

◆Part List

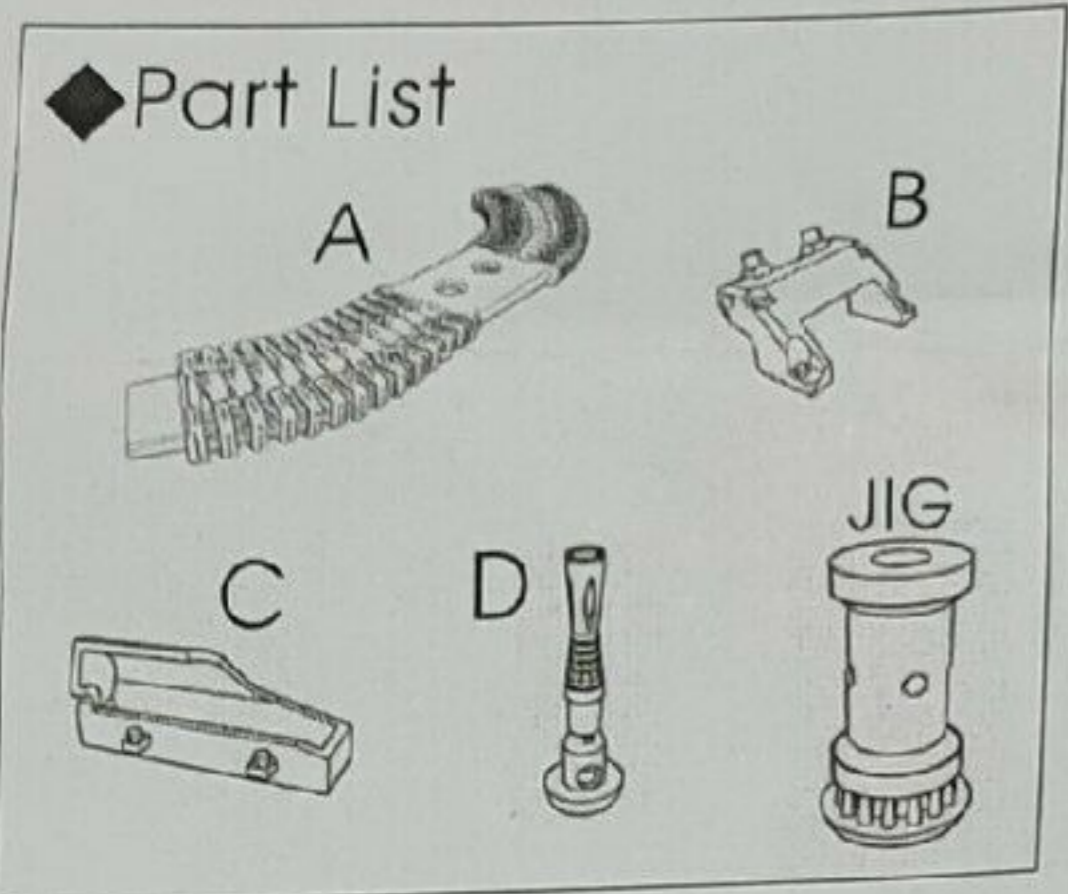

◆Part A

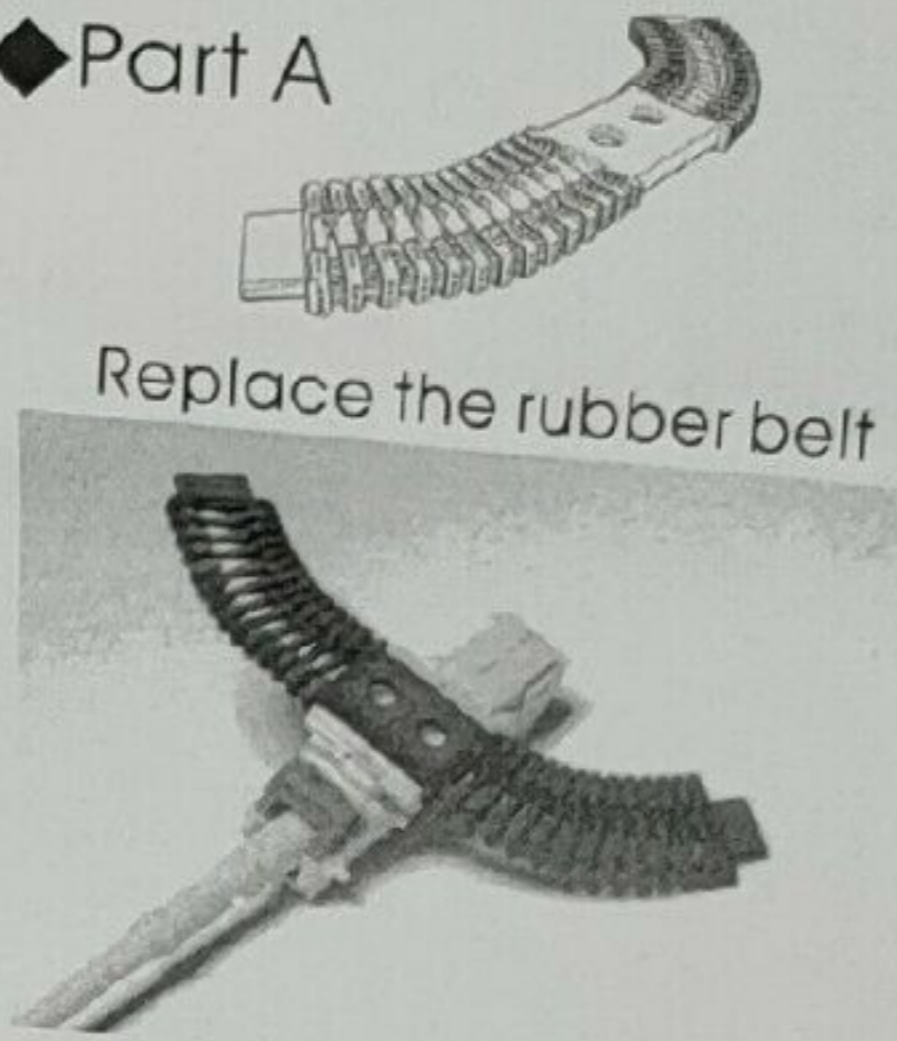

◆Part B

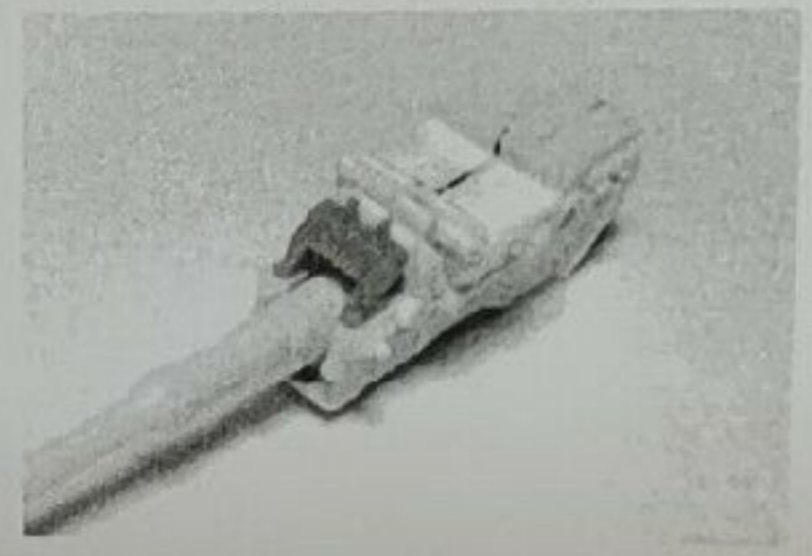
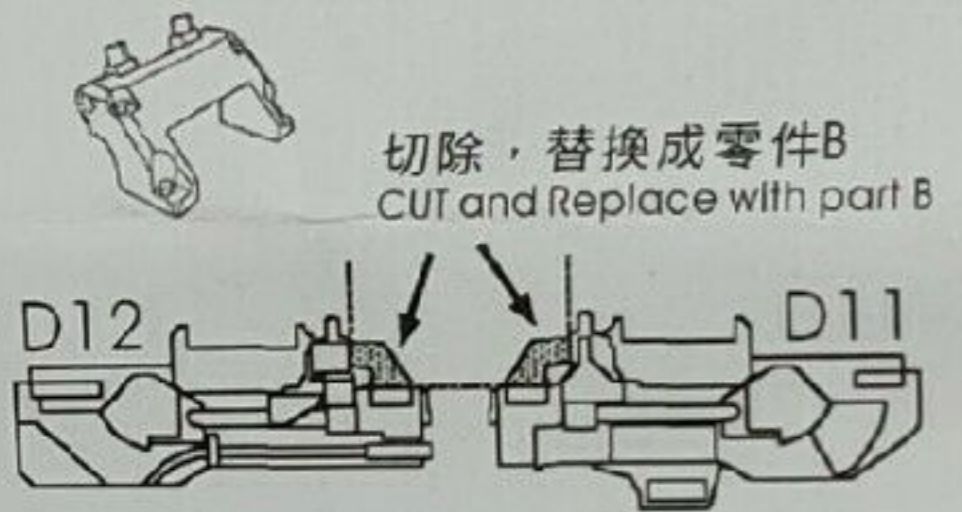

◆Part C

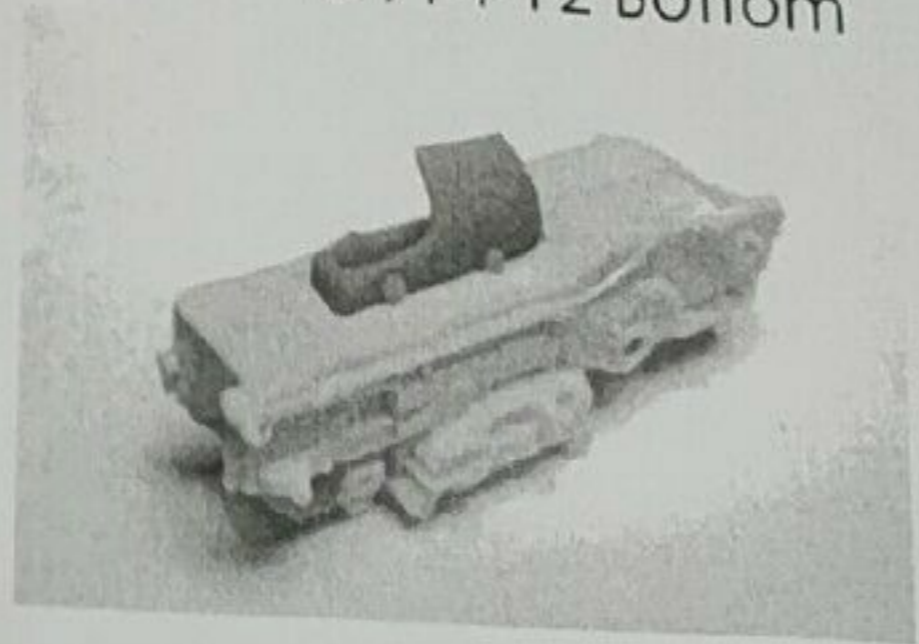
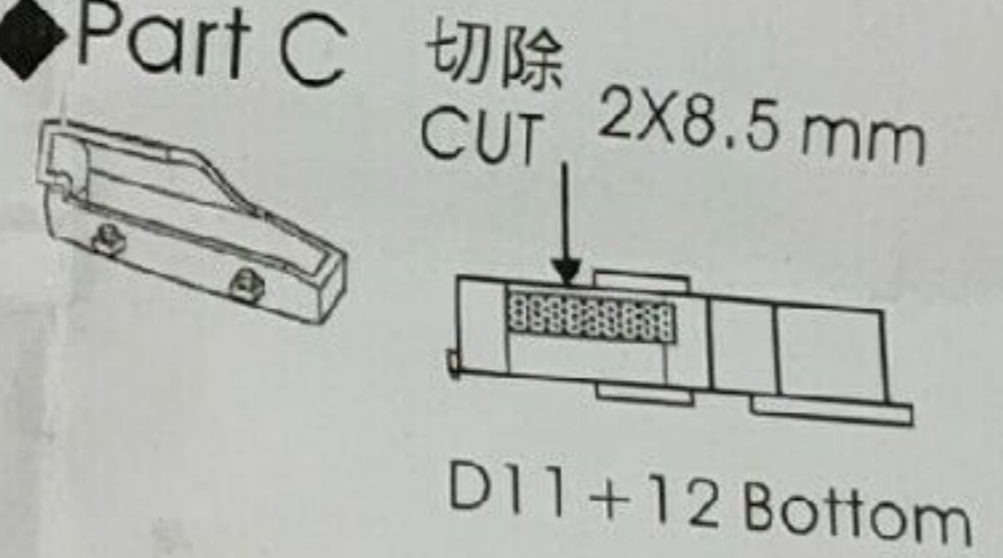

◆Part D and JIG

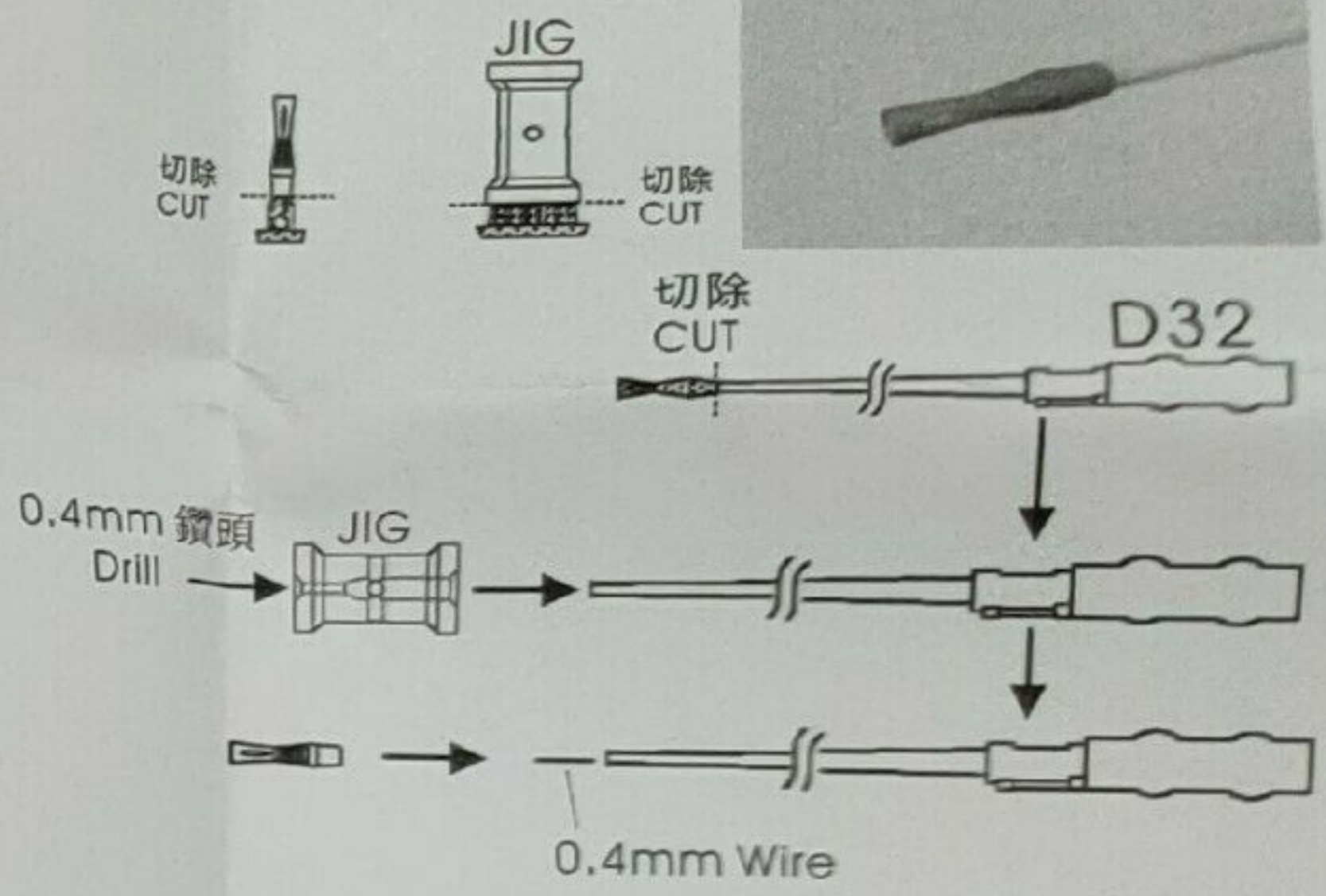

◆注意事項◆

- ◆零件未上漆前勿久置於陽光下，過度曝曬會導致零件變脆易斷。
- ◆建議購買開封後先噴上底漆/液態補土保護。
- ◆零件若有變形可用熱水/吹風機熱矯正。
- ◆若表面黏膩，可使用95%酒精稍加刷洗，但請勿浸泡超過3分鐘。
- ◆支撐拆除痕跡可能殘留些許細小支柱，可用刀剪/砂紙去除。

◆Notice◆

- ◆ Do not expose the parts to the sun before they are painted. UV light will cause the parts become hard and brittle.
- ◆ It is recommend to spray the primer/surfacer first.
- ◆ If the surface is sticky, use 95% alcohol to clean, but don't soak for more than 3 minutes.
- ◆ If the parts deformed, use hot water/hair dryer to adjust.
- ◆ The support removal marks on the parts may leave some small pillars, it can be removed with knife & sandpaper.