

Gloster Gladiator Mk. I, K6130
of 72 Squadron, RAF Church Fenton, 1937

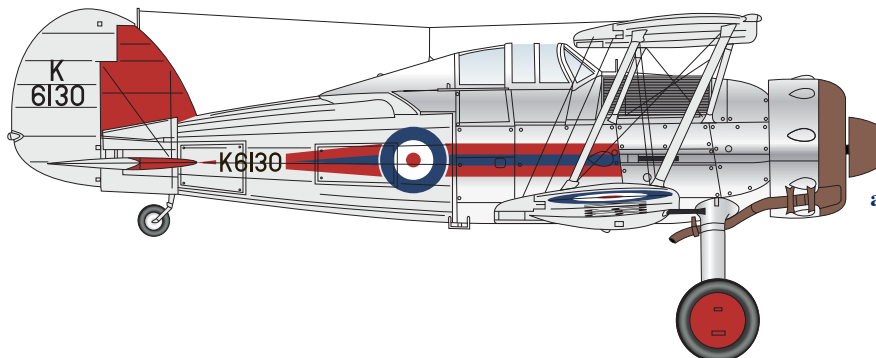

Modellers Note:
Red disc decals are included for the wheel hubs
and Red coloured panel decals for the tail and fin surfaces.

**Gloster Gladiator I,
K7985, Flown by Flying Officer E. J. 'Cobber' Kain
of 73 Squadron, RAF Digby, 1937.**

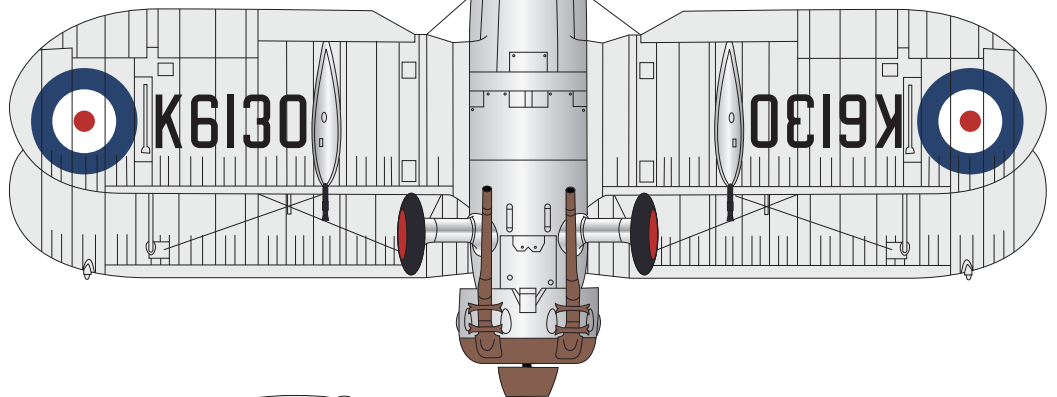
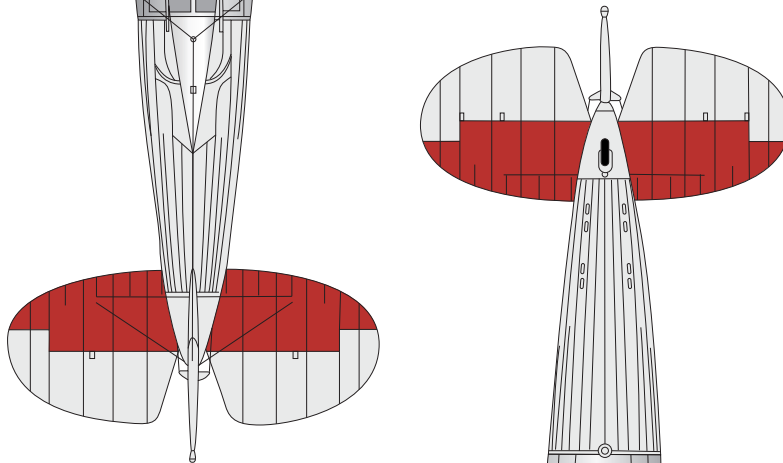
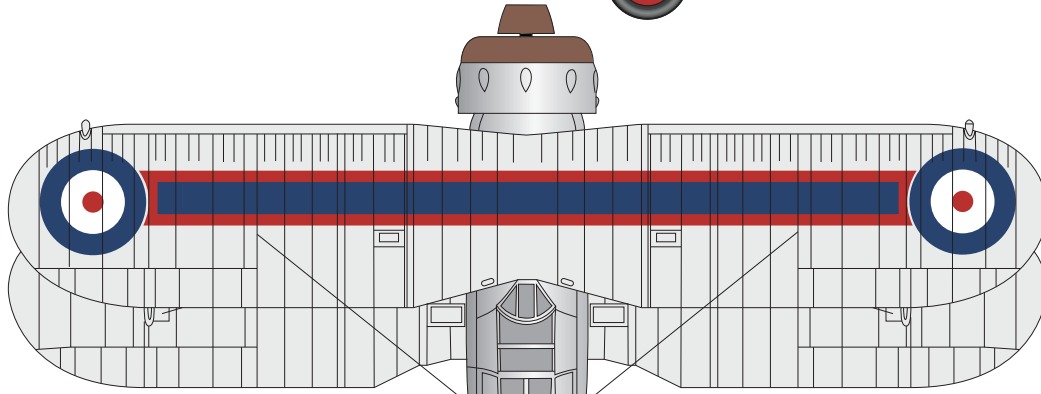
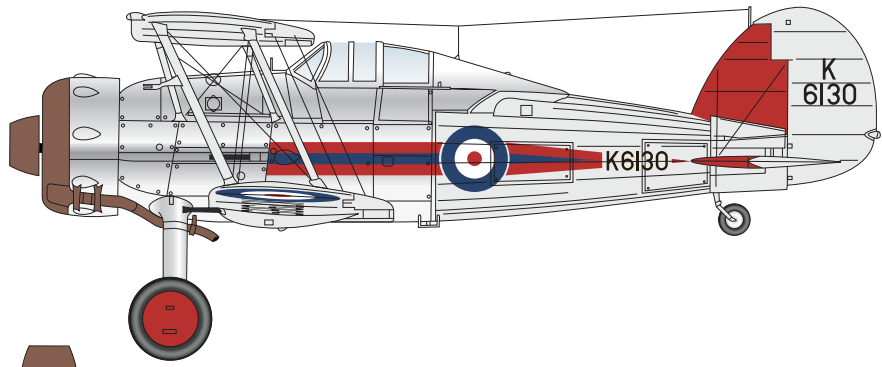
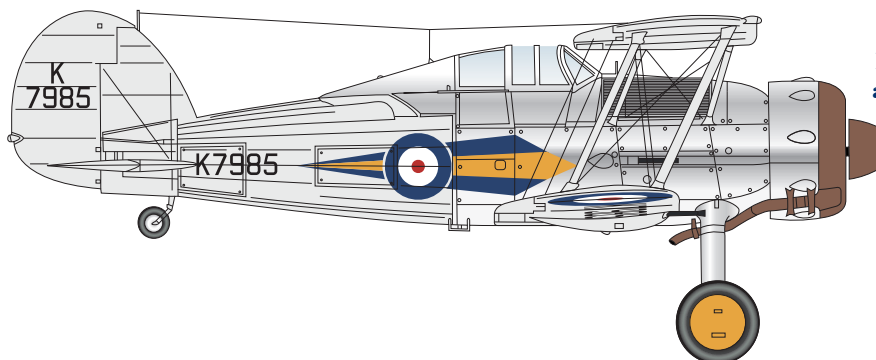
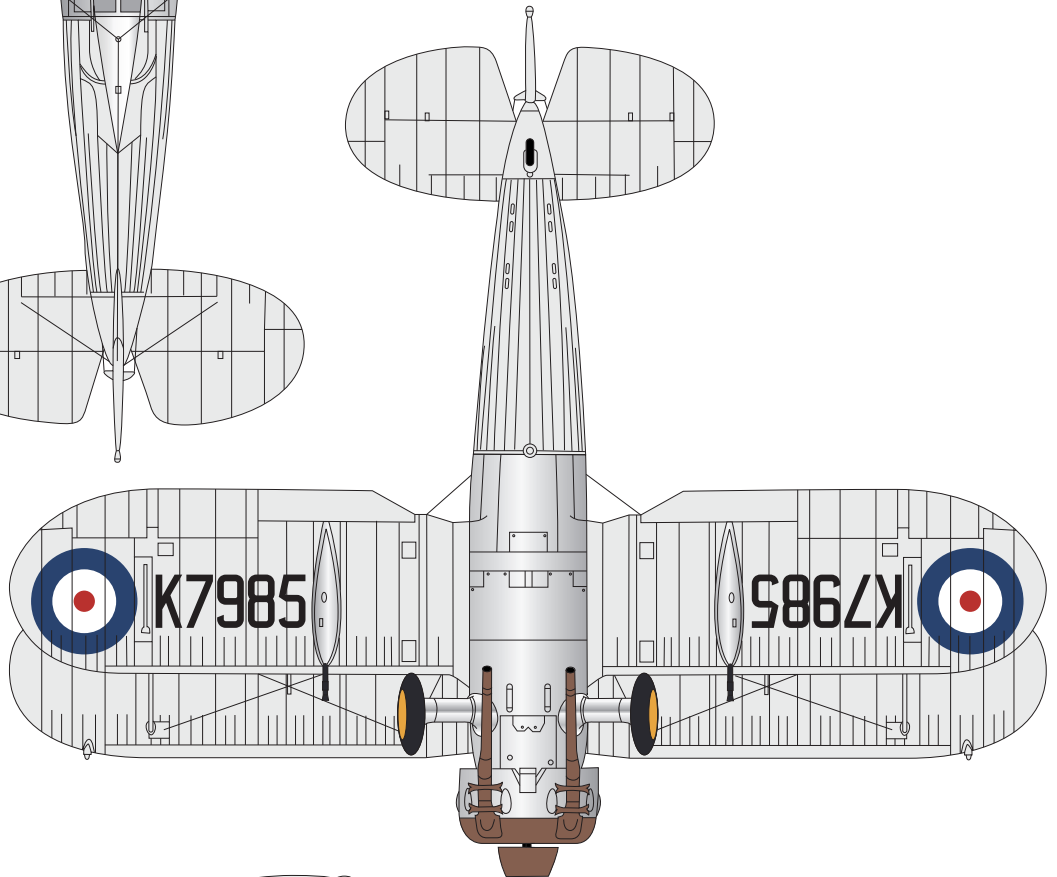
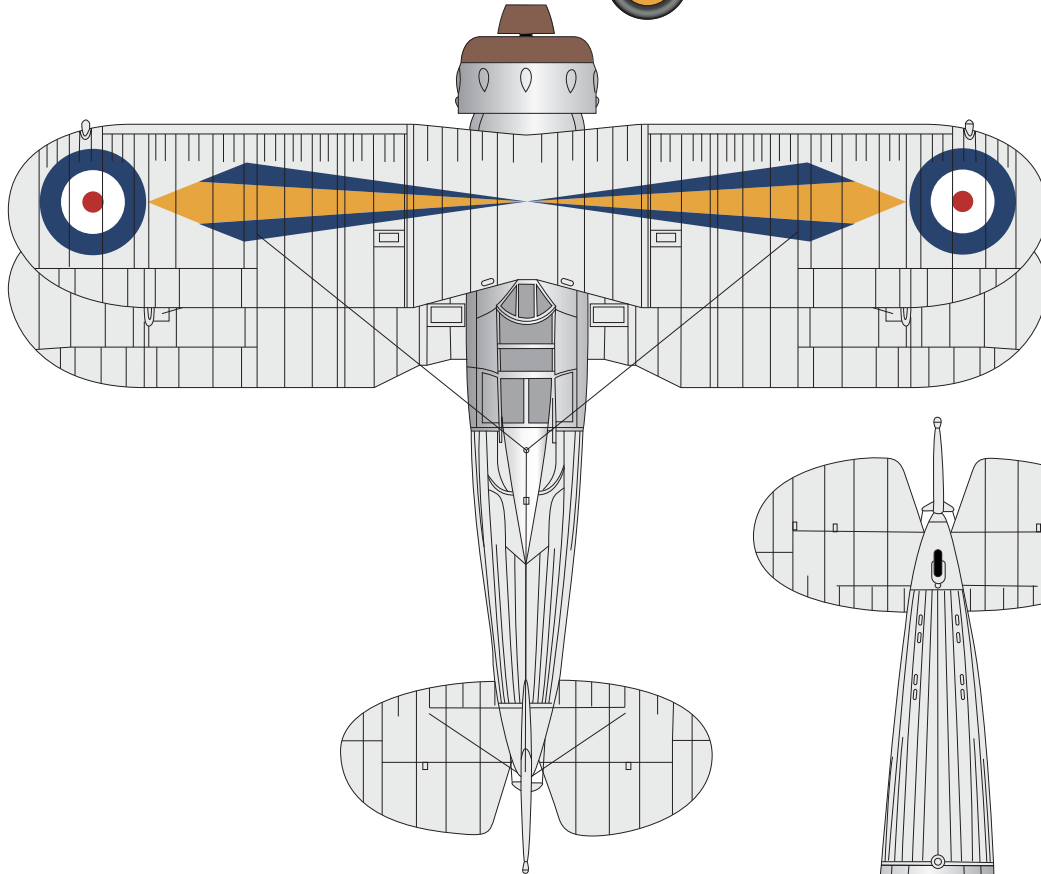
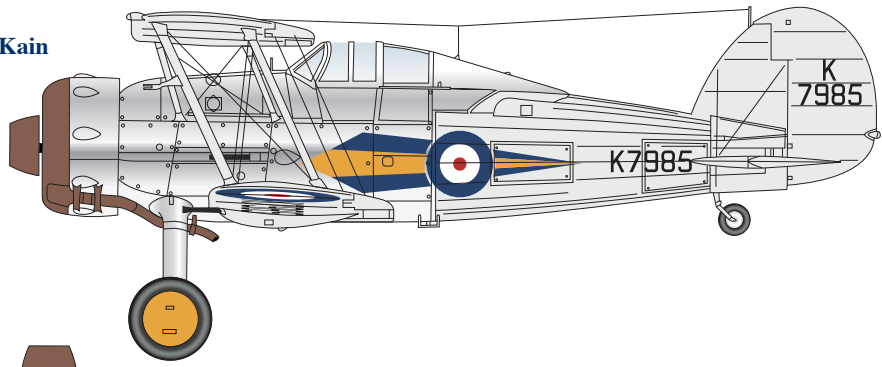

Modellers Note:
Red or Yellow disc decals are included for the wheel hubs
as it was possible either colours were applied at that time
in service.

Gloster Gladiator Mk. I, K7974
of 87 Squadron, RAF Shoreham, 1938

