

eduard
MASK

JX 127

He 111P 1/32

The die-cut mask for accurate canopy frame painting of the
Revell scale 1/32 KIT



JX127-A

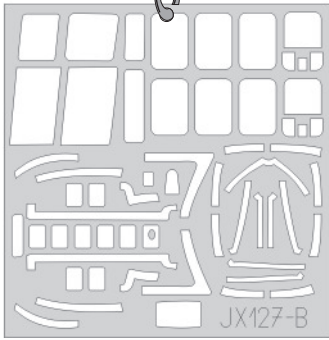

JX127-B

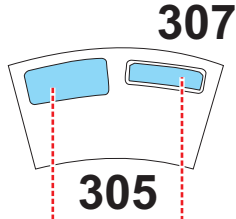

305

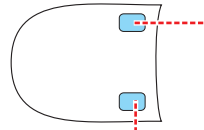

112

94

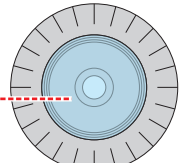

4x

1.)

2x

149

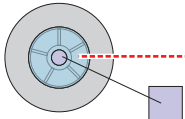

LIQUID MASK

172

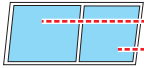

174

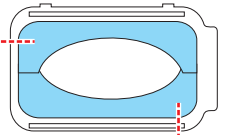

175

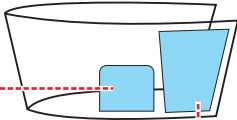

175

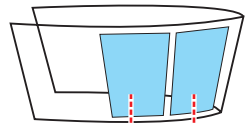

2.)

177

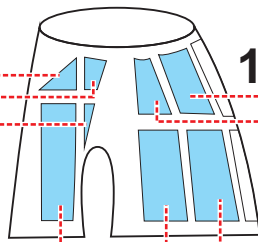

3.)

177

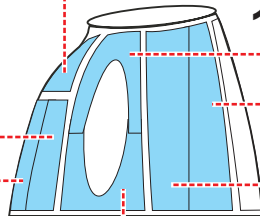

4.)

177

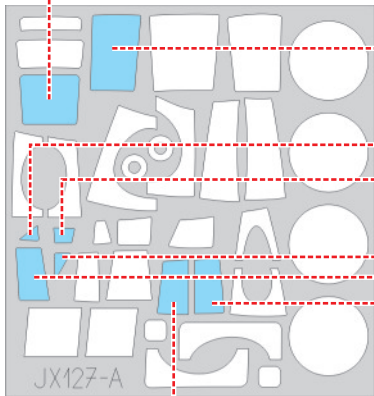
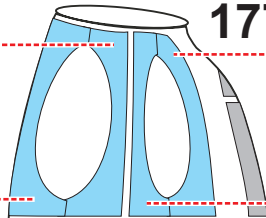

JX127-A

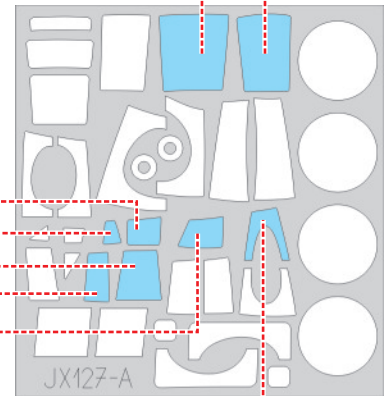

JX127-A

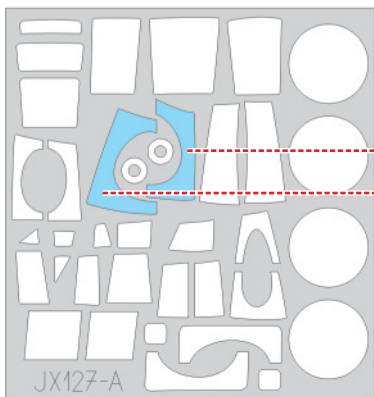

JX127-A

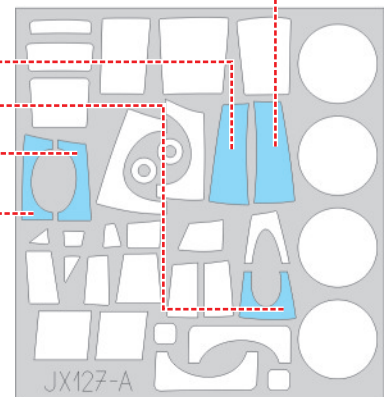

JX127-A

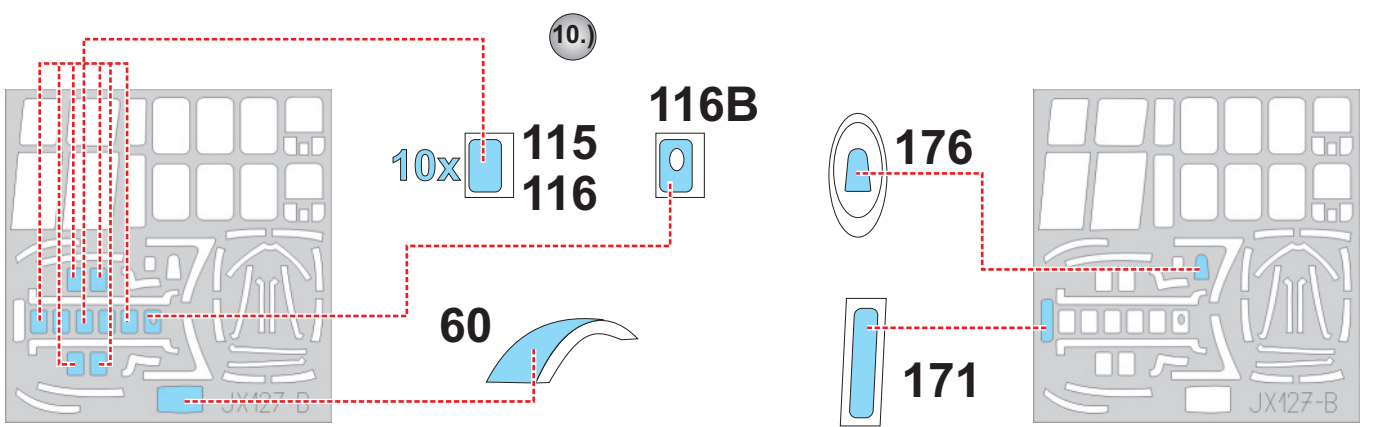
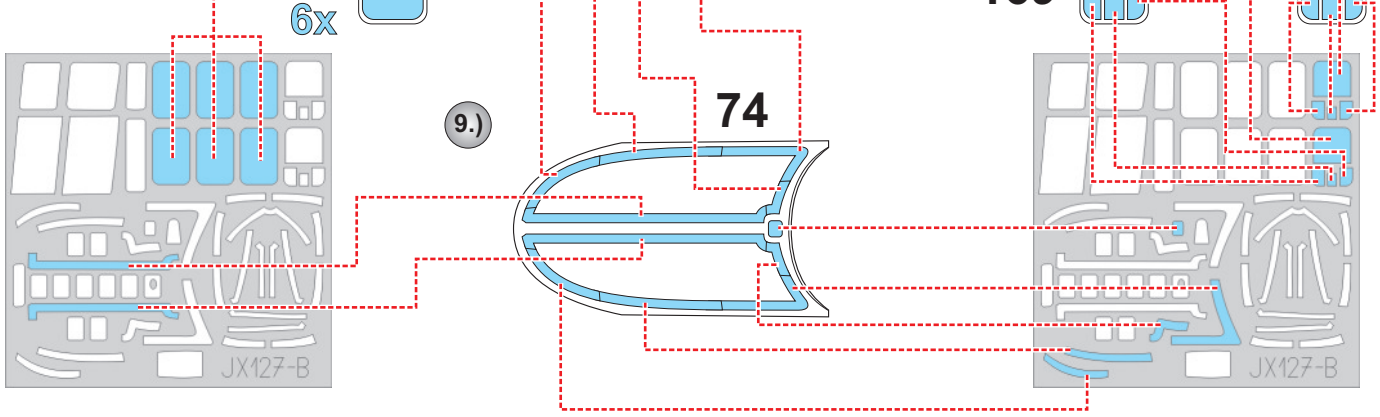
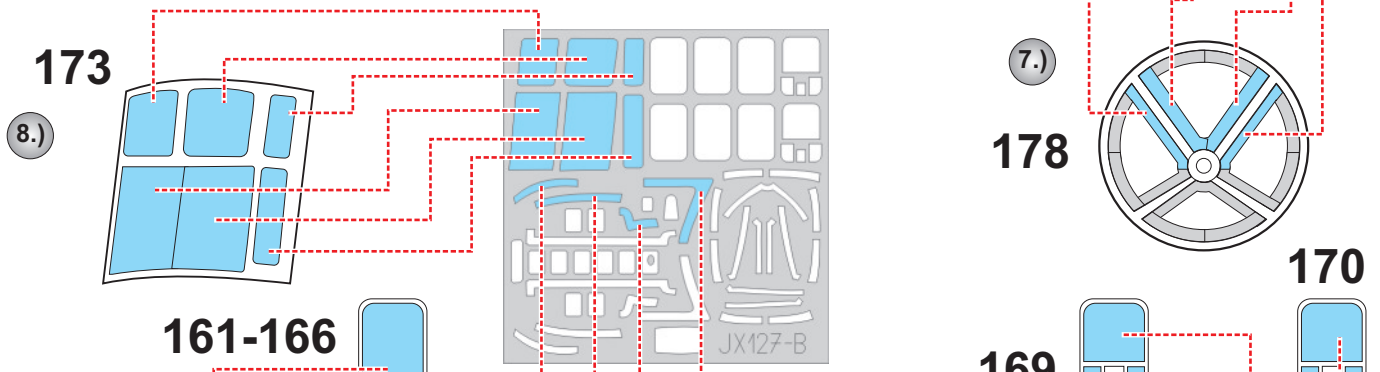
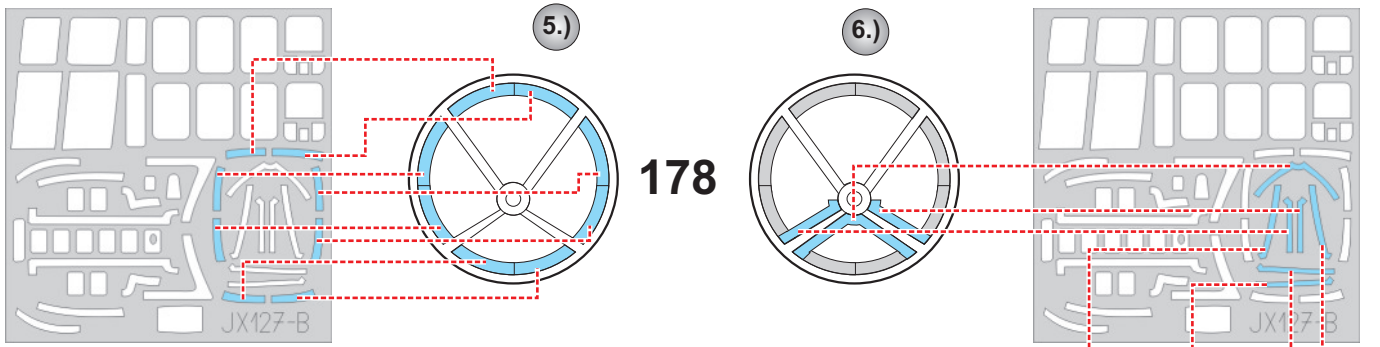

11. LIQUID MASK ■

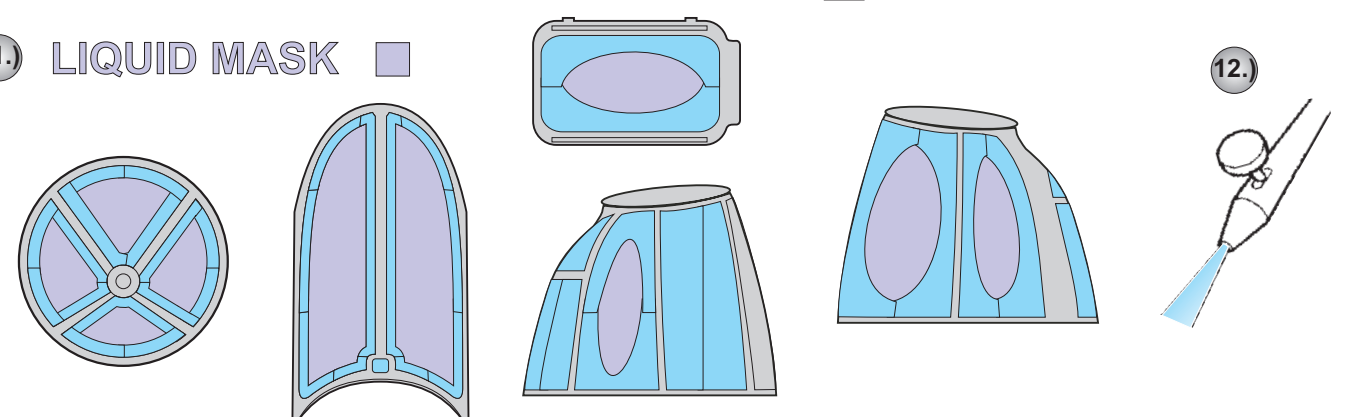

eduard
MASK

JX 127

He 111P 1/32

The die-cut mask for accurate canopy frame painting of the
Revell scale 1/32 KIT

