

* .ZS-55 Conversion set

() : Opposite side

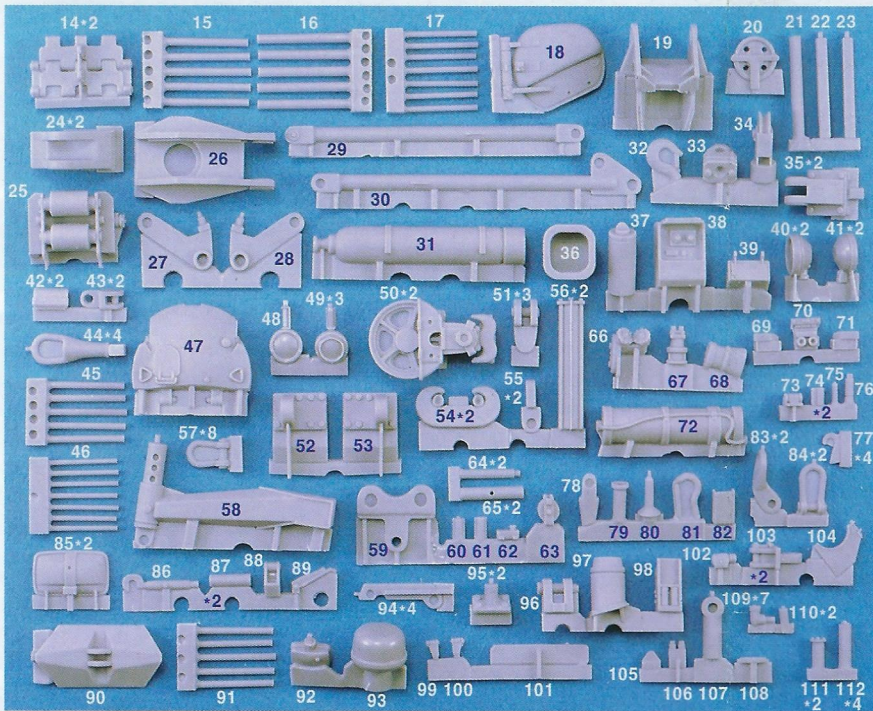

- *. Resin Parts : #1~#13, Bolts : A,C,E,F
- *. Optional Clear Resin Parts : 40*2, 41*2, 48, 49*3, 92, 93
- *. 0.3mm Brass Wire(B/W) : 25cm, 0.5mm B/W : 25cm, 0.7mm Brass Rod(B/R) : 1m, Rubber Wire(R/W) : 20cm
- *. Nylon Thread : Thick White(W/K) : 40cm, Thin White(W/N) : 40cm, Black(B/K) : 40cm
- * PE plate*2

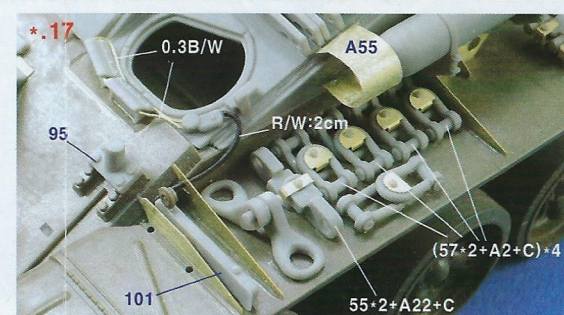
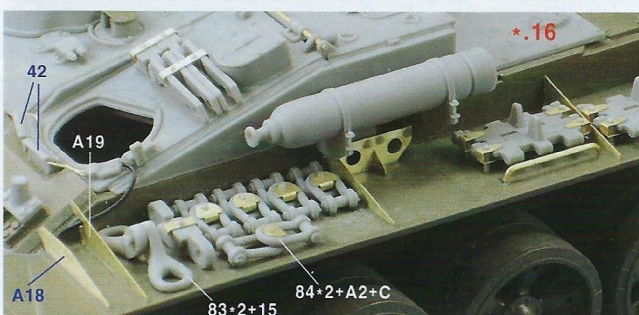
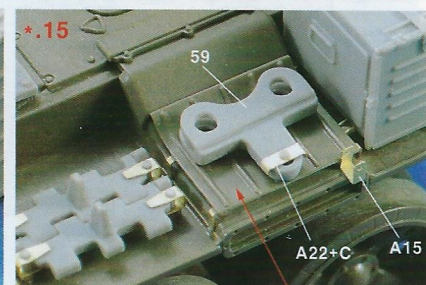
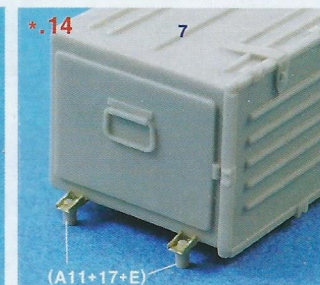
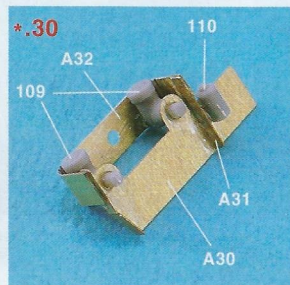
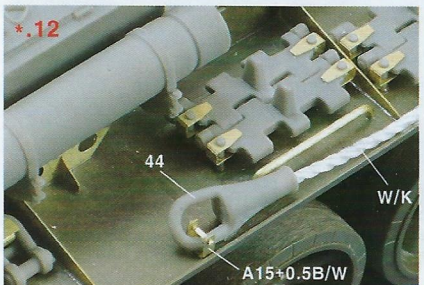
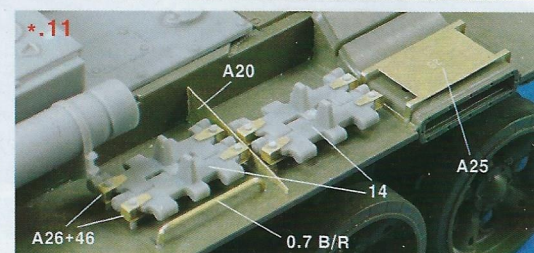
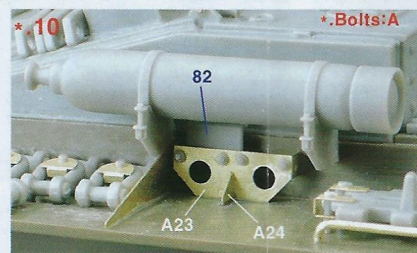
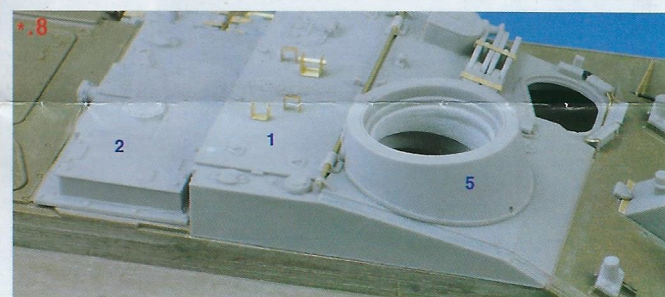
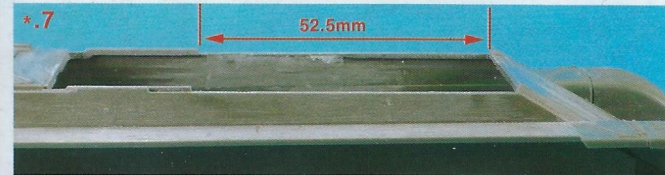
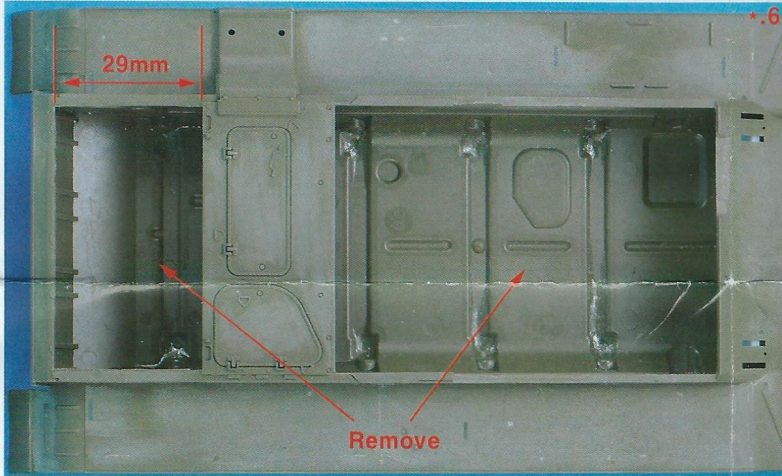
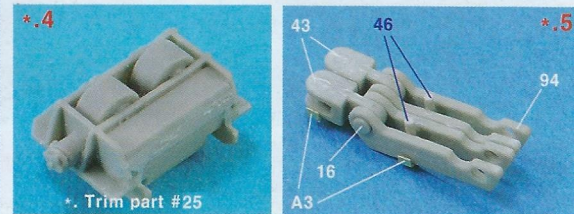

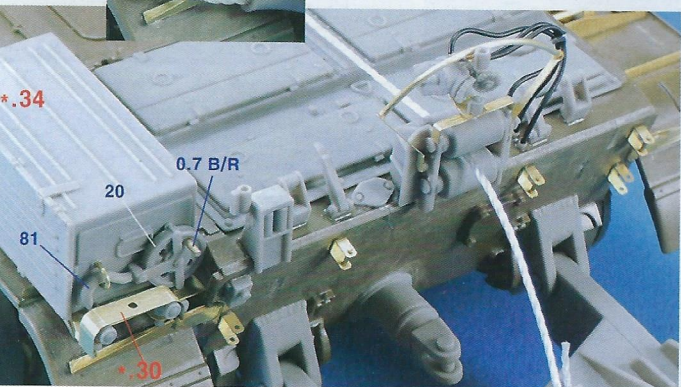
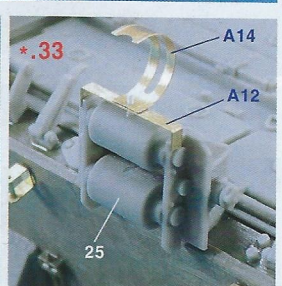
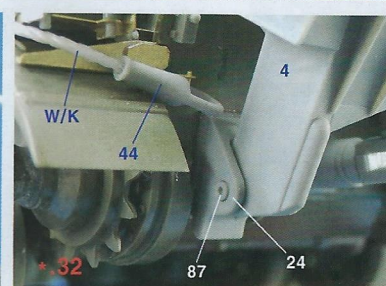
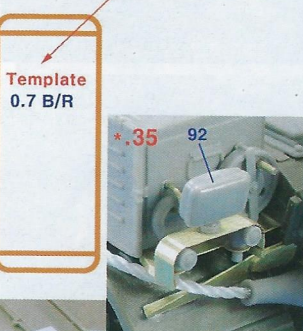
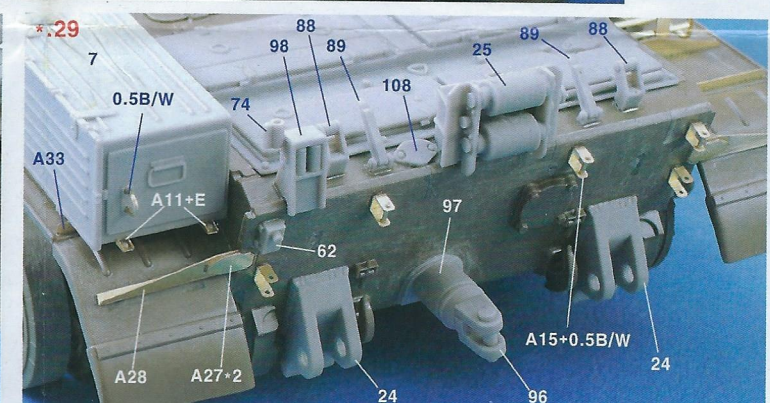
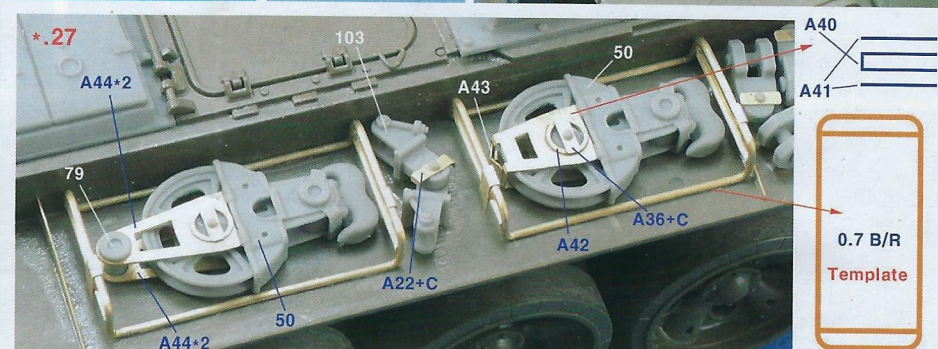
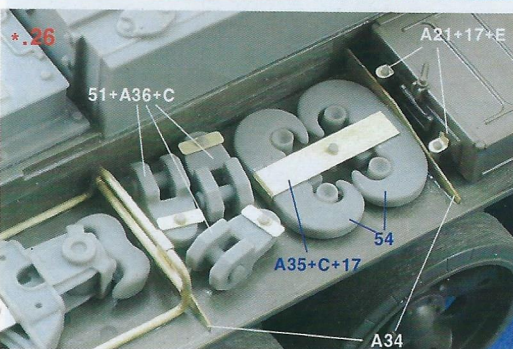
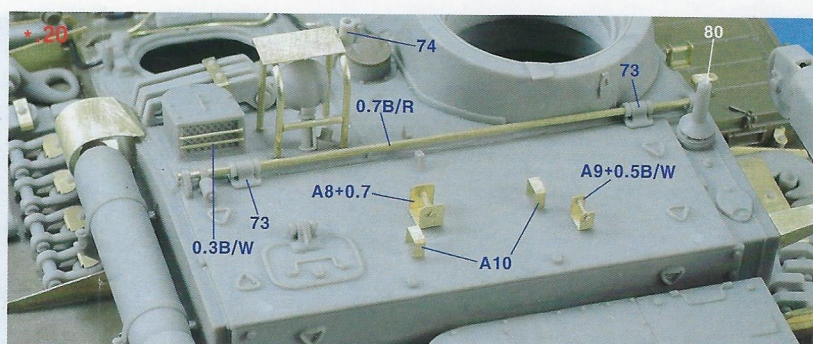
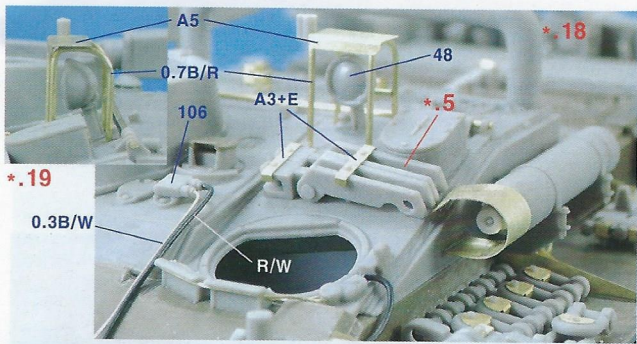

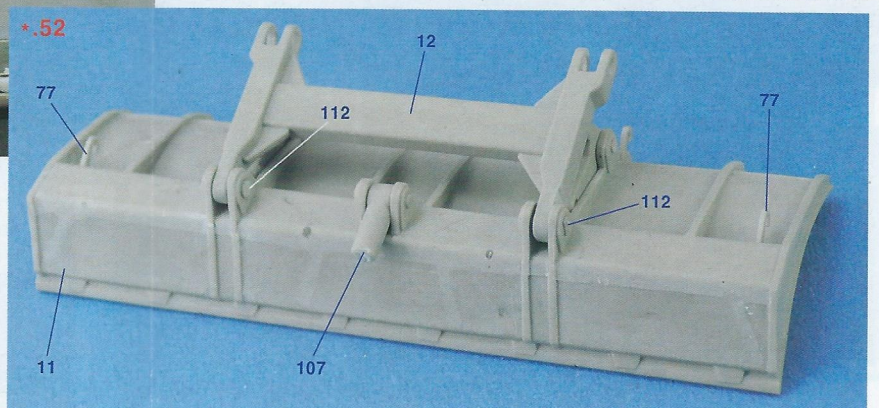
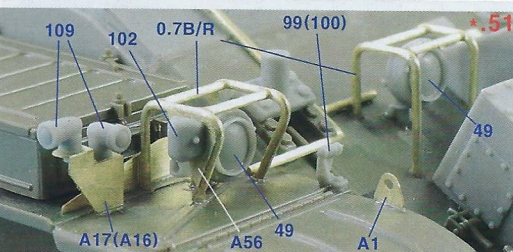
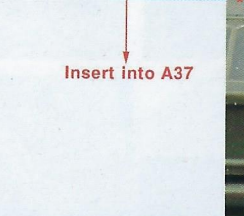
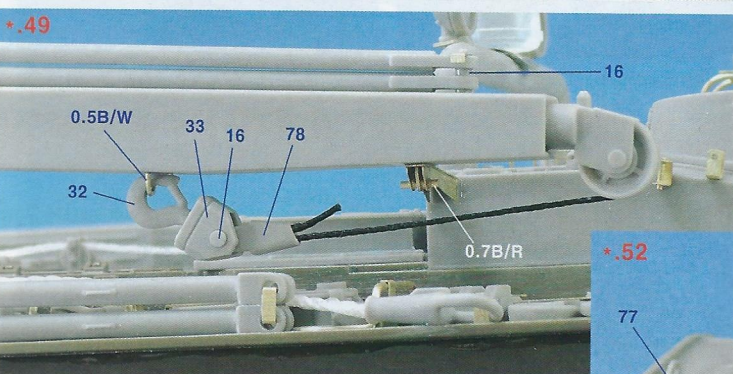
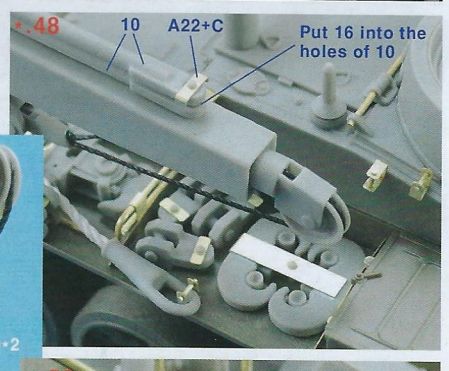
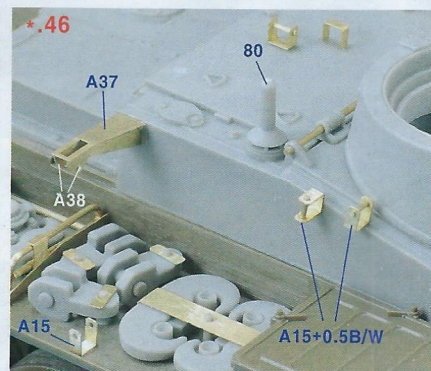
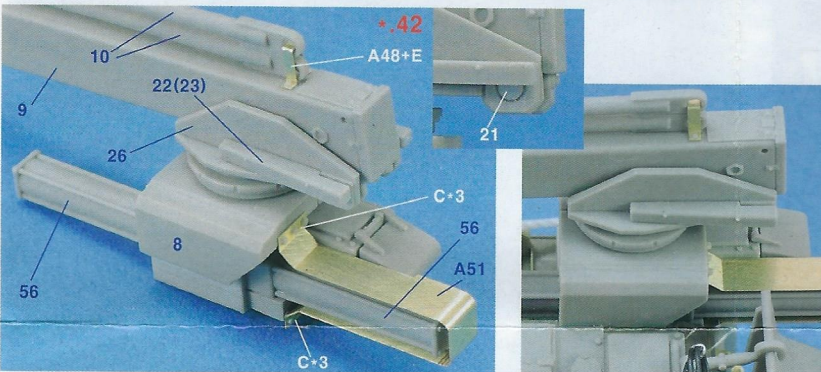
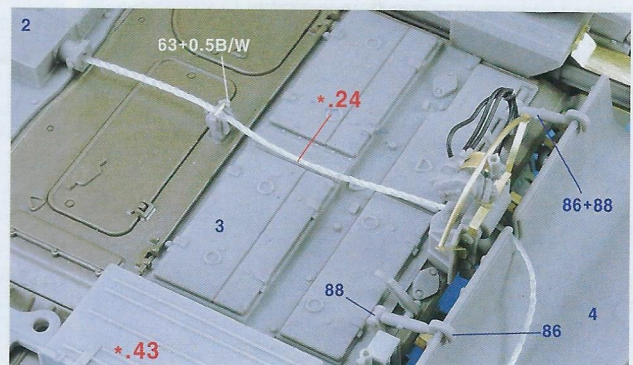
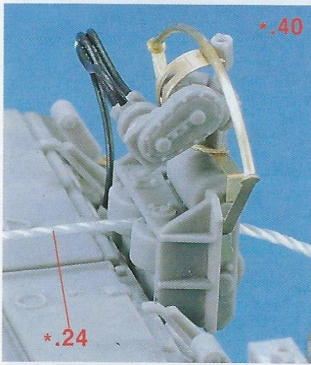
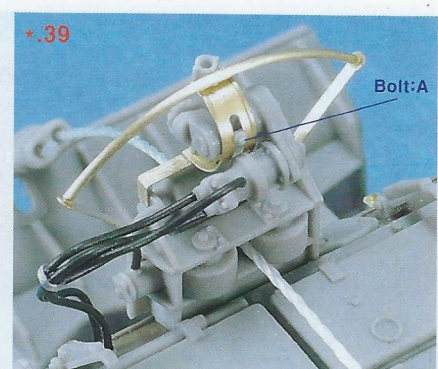
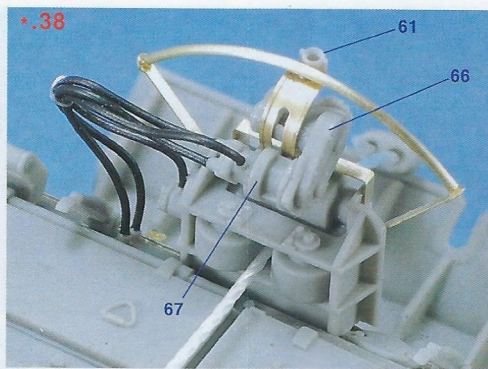
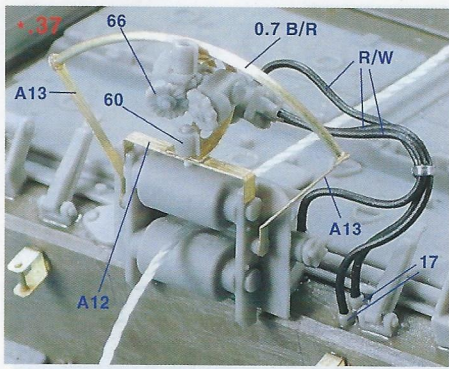

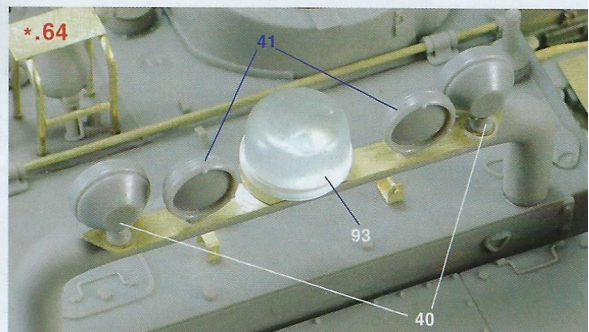
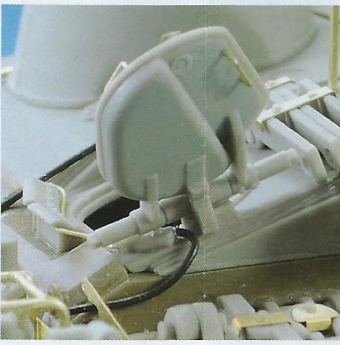
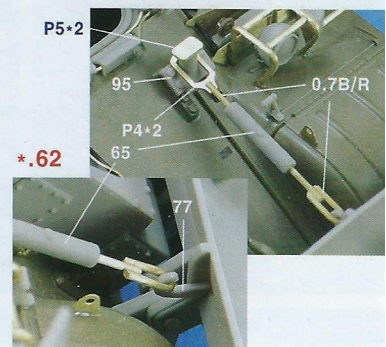
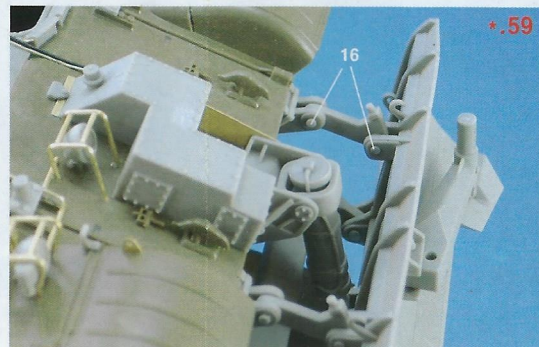
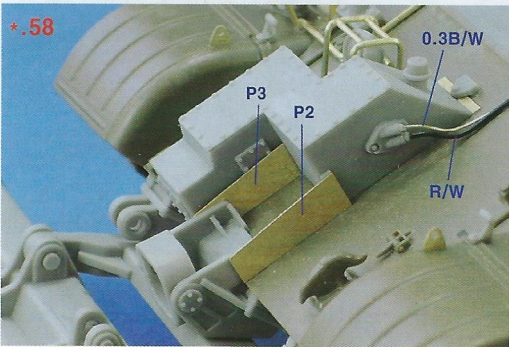
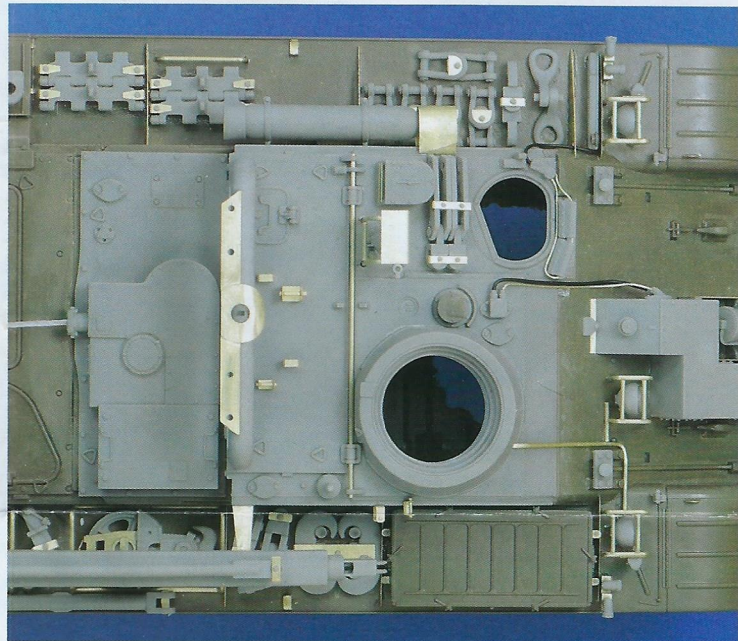
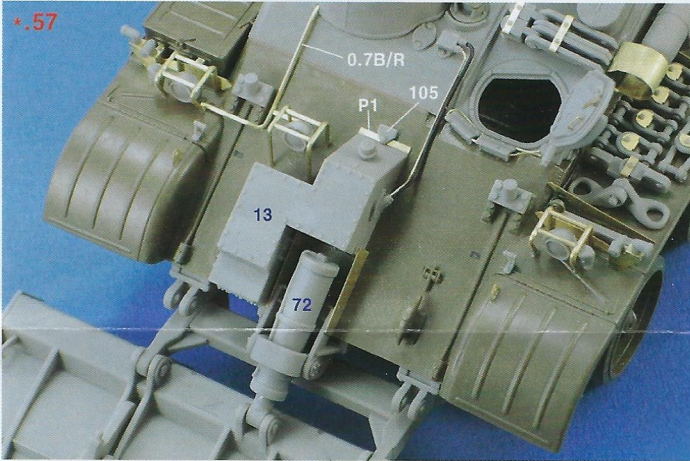
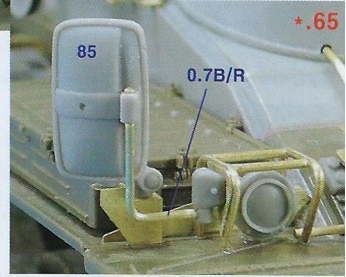
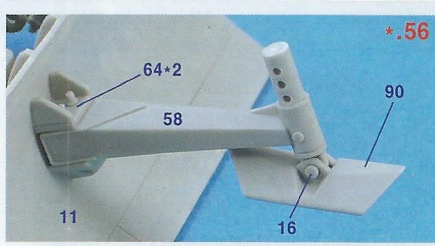
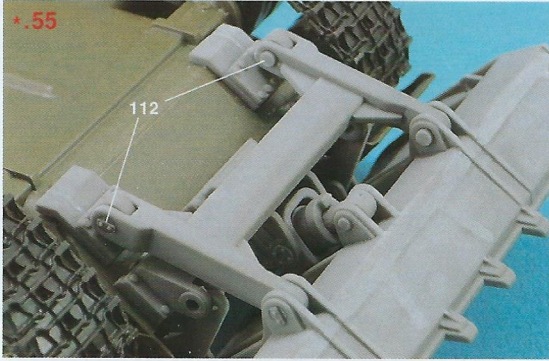
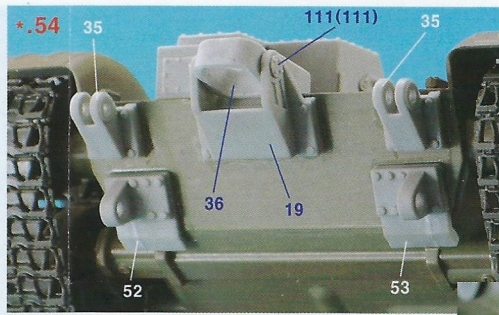
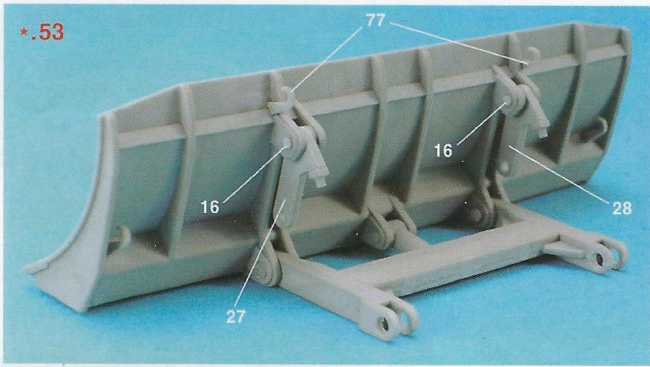

*. Painting and Applying Decal

() : Opposite side

