

1/35 MILITARY MINIATURE VEHICLE UPGRADE SERIES PE35247









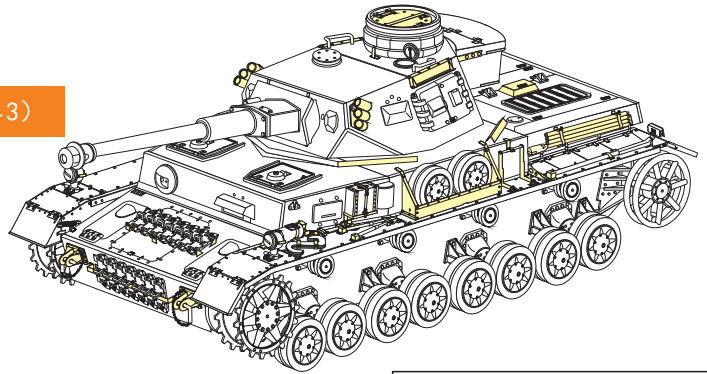
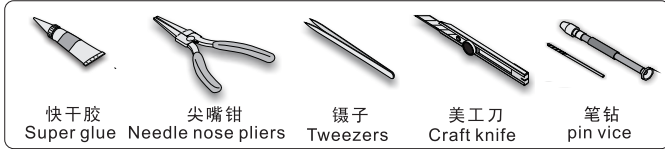



WWII German Pz.Kpfw.IV Ausf.G (LAH Division Kharkov 1943)

二战德军IV号坦克G型改造件 (LAH师 哈尔科夫 1943)

[For DROGON 6363]

■ 推荐使用工具 RECOMMENDED TOOLS



- 
 安装
install
- 
 折叠
bend
- 
 改造件零件编号
PE/resin part number
- 
 原零件编号
kit part number
- 
 被替换的原零件编号
replaced kit part number
- 
 另一侧相同制作
repeat on opposite side
- 
 切除
remove
- 
 打磨
grind off
- 
 弧度卷曲
radial bending
- 
 制作若干组
multiple assembly
- 
 选择安装
alternative
- 
 钻孔
drill
- 
 用胶棒制作
make from plastic rod

 用尖端在凹槽处冲压
use penpoint to press on the dent

蚀刻片零件内侧面向上
Put the part upside down
 用笔尖在凹槽处刻
Use penpoint to press on the dent

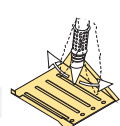
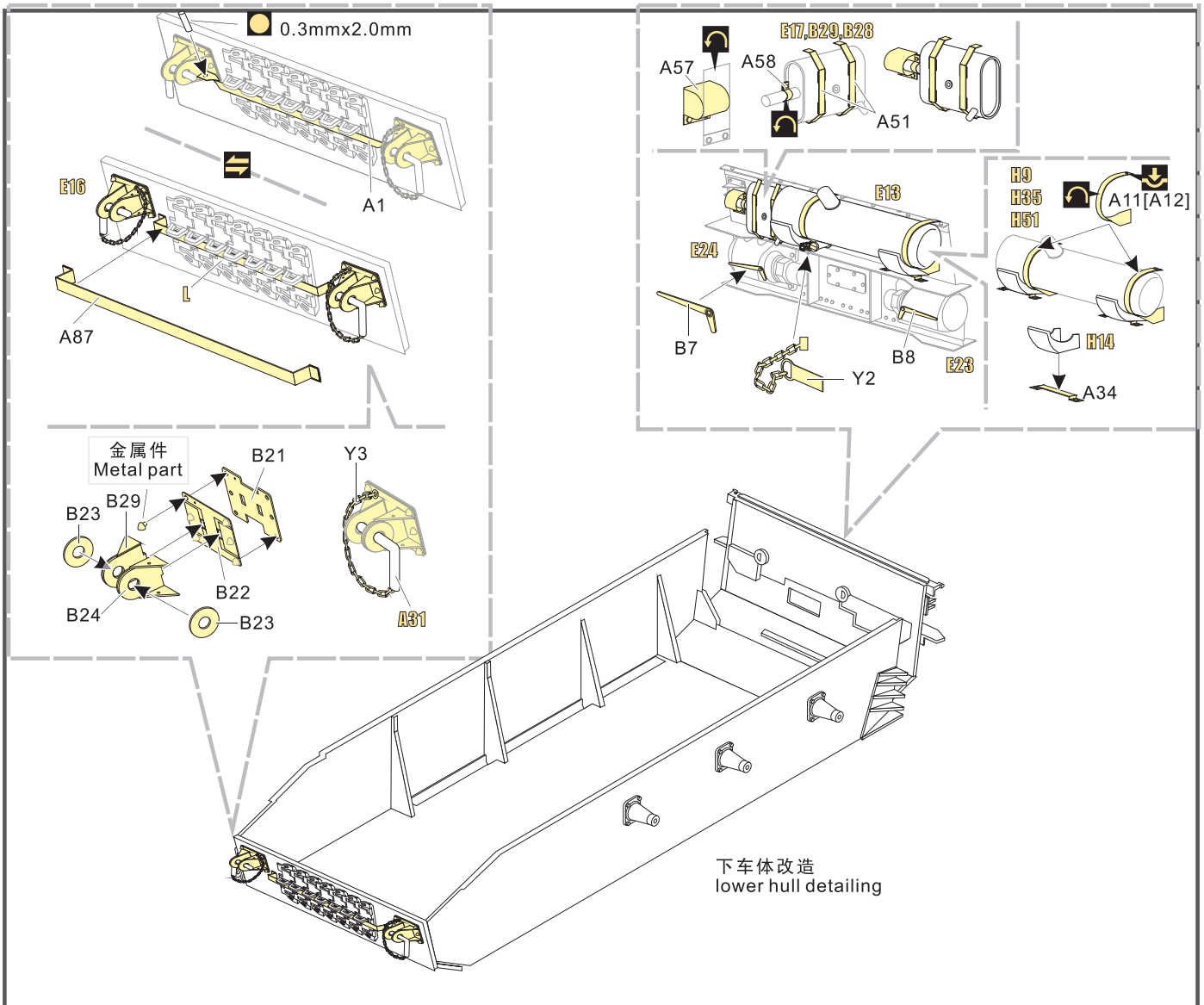
1/35 MILITARY MINIATURE VEHICLE UPGRADE SERIES PE35247

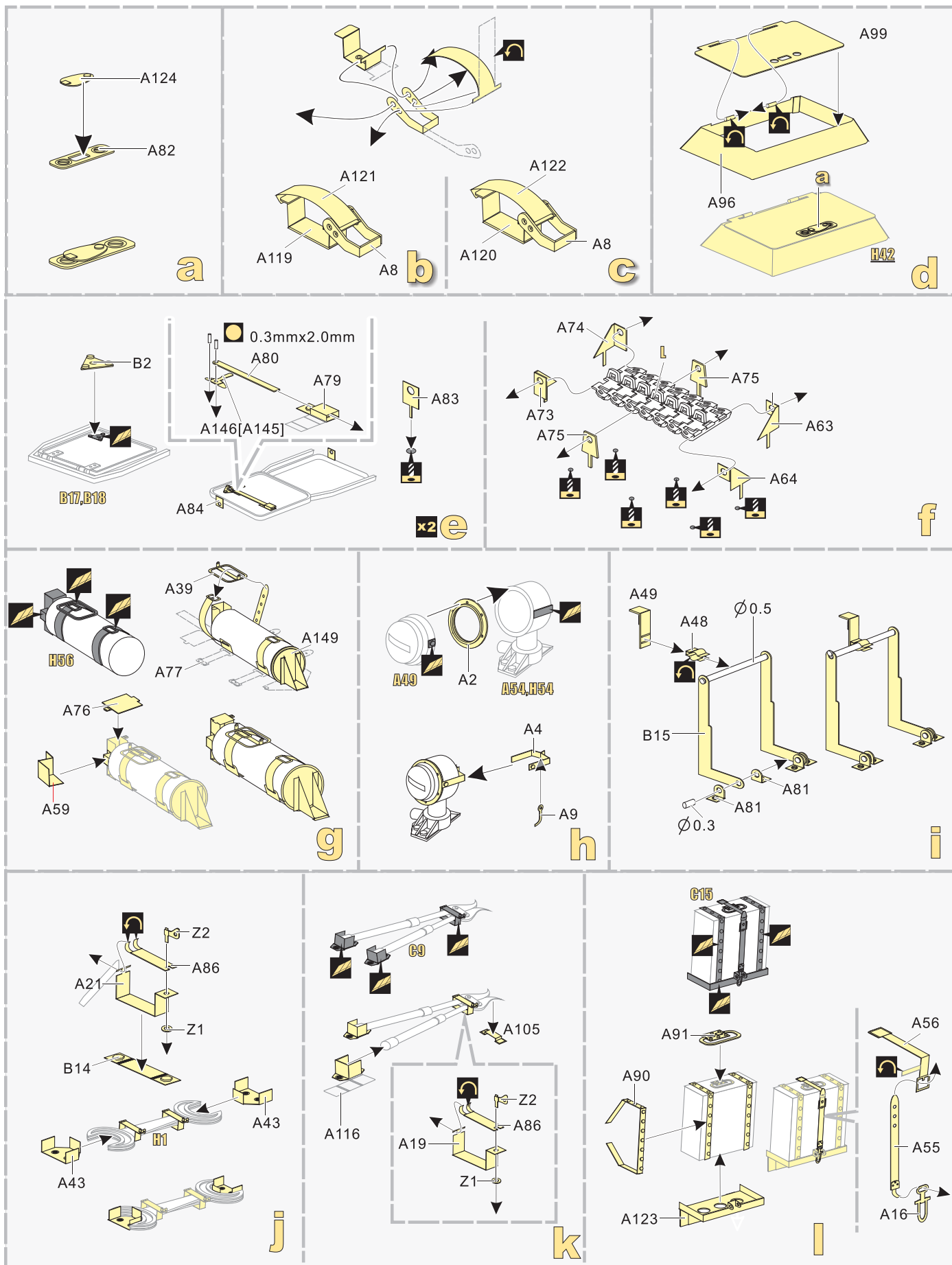

1/35 MILITARY MINIATURE VEHICLE UPGRADE SERIES PE35247

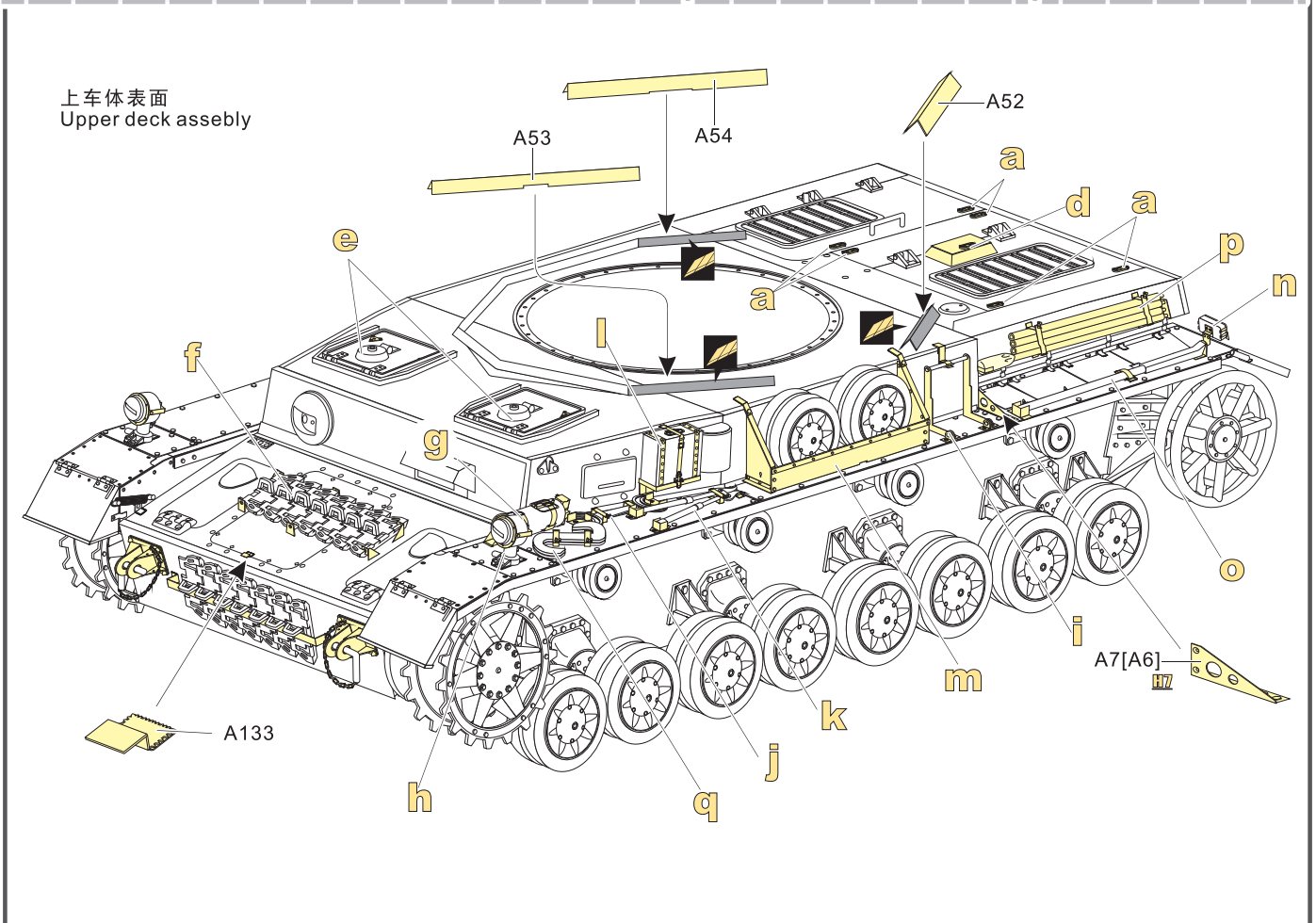
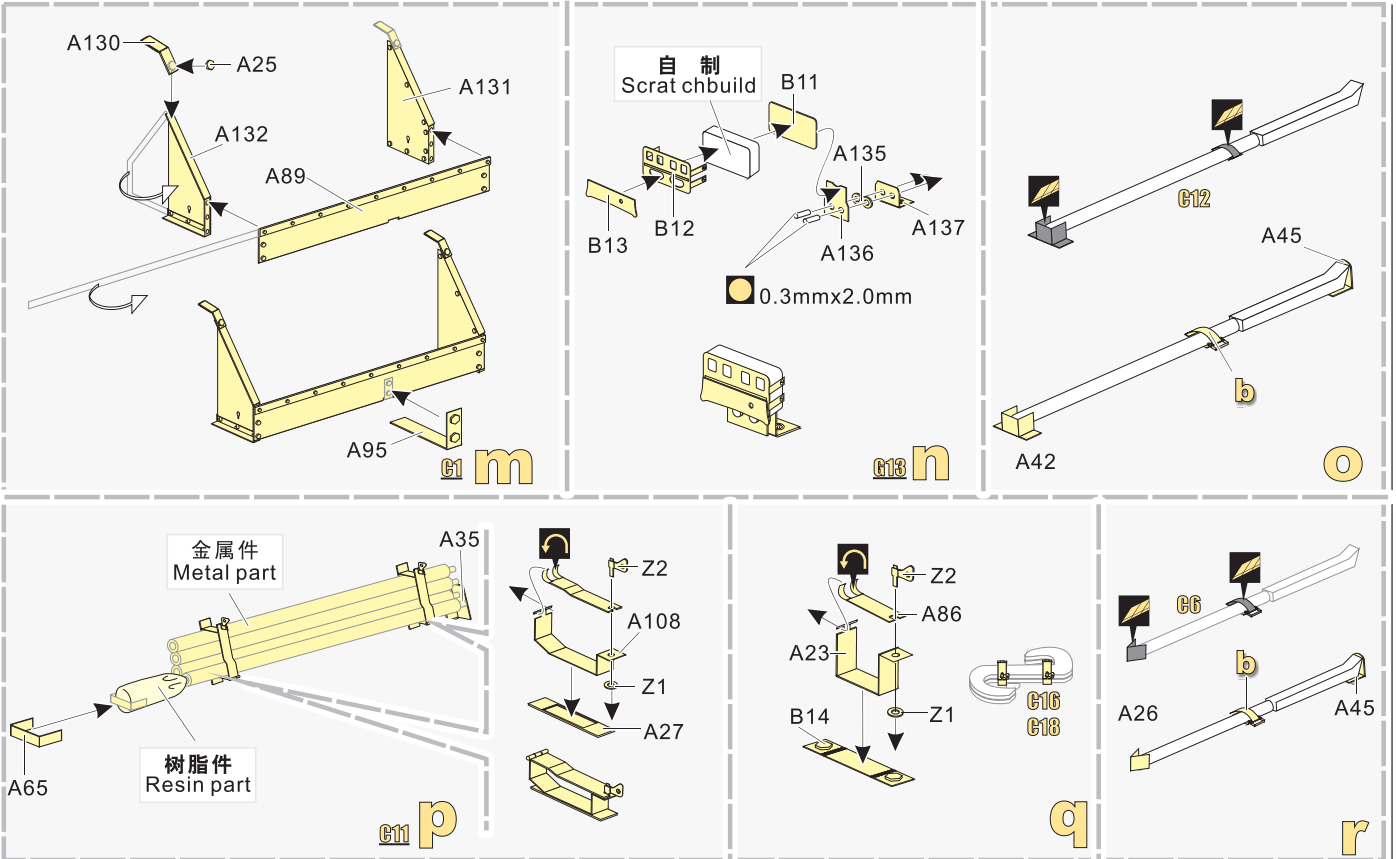

1/35 MILITARY MINIATURE VEHICLE UPGRADE SERIES PE35247

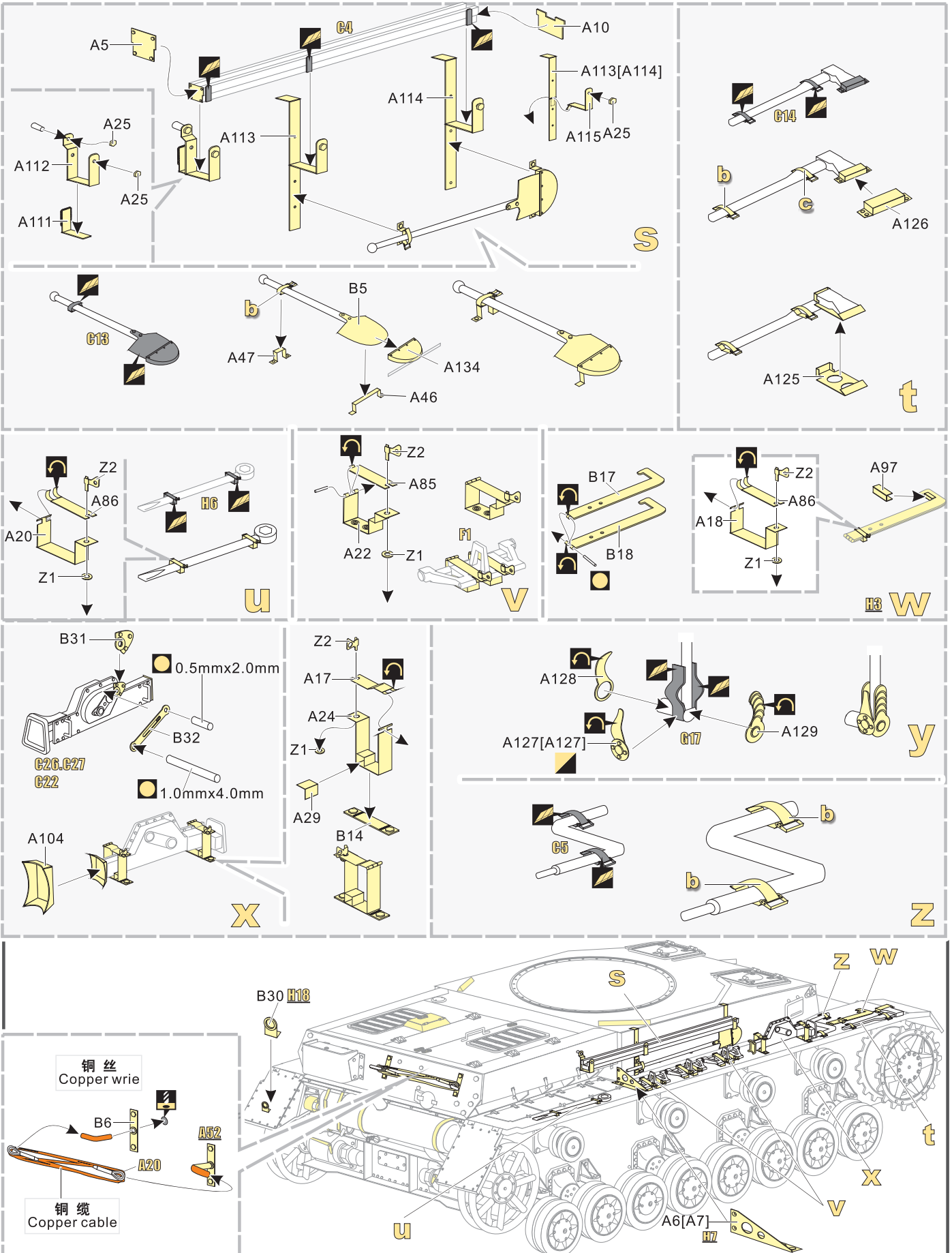

1/35 MILITARY MINIATURE VEHICLE UPGRADE SERIES PE35247

炮塔部分
turret section

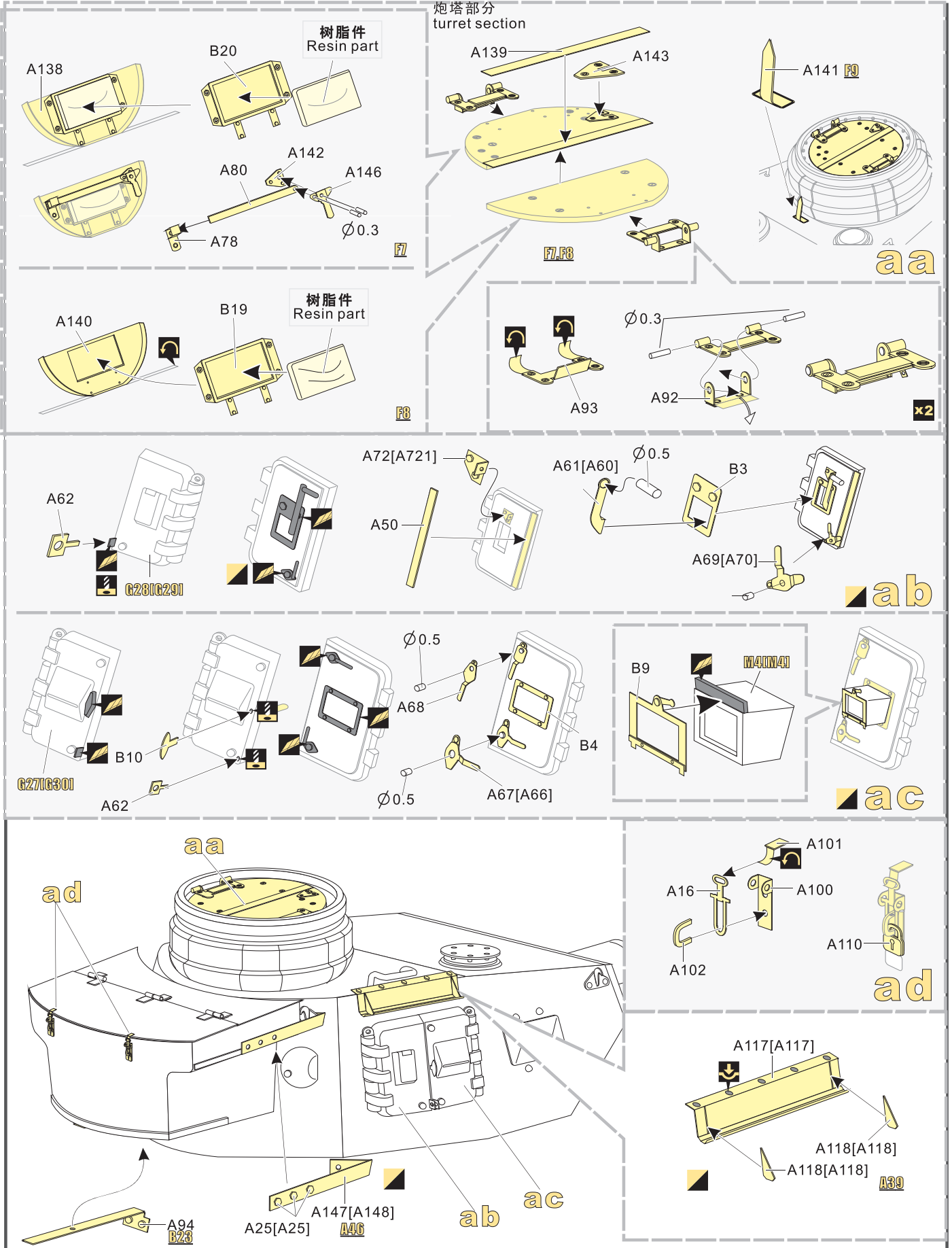

1/35 MILITARY MINIATURE VEHICLE UPGRADE SERIES PE35247

