

RONIN DECALS

LIMITED EDITION DECALS

Copyright 2022©

<https://roningraphicsaustralia.com>

www.facebook.com/Ronin-Graphics-Australia



Royal Australian Air Force
2 Squadron
B737-7ES Wedgetail AEW&C
including
Operation Okra Aircraft



The RAAF Roundel, Squadron markings and badges have been reproduced under license and with the permission and approval of the Royal Australian Air Force.

RDS-093

Fully Screen Printed

Designed and Printed by Ronin Graphics Australia

1/144

1/72



737-7ES Wedgetail Paint Masks

for 1772 BPK Kit

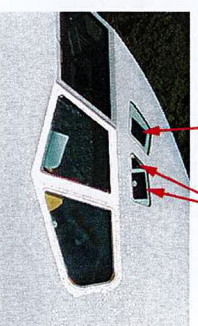
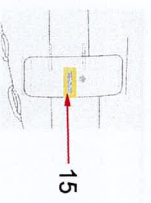
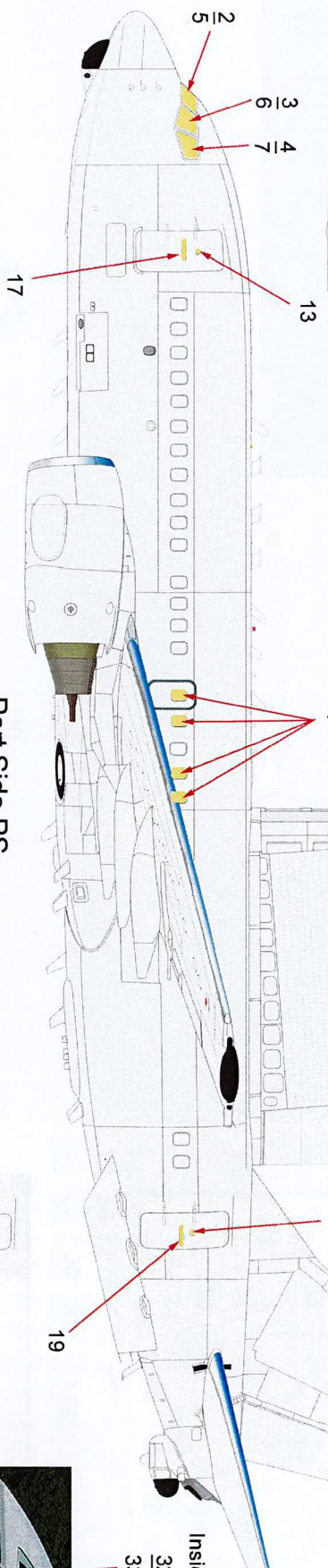
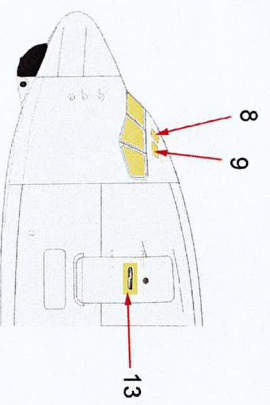

Inside upper windows
32 PS
33 SS
34 PS
35 SS

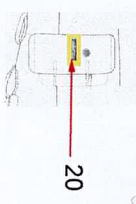
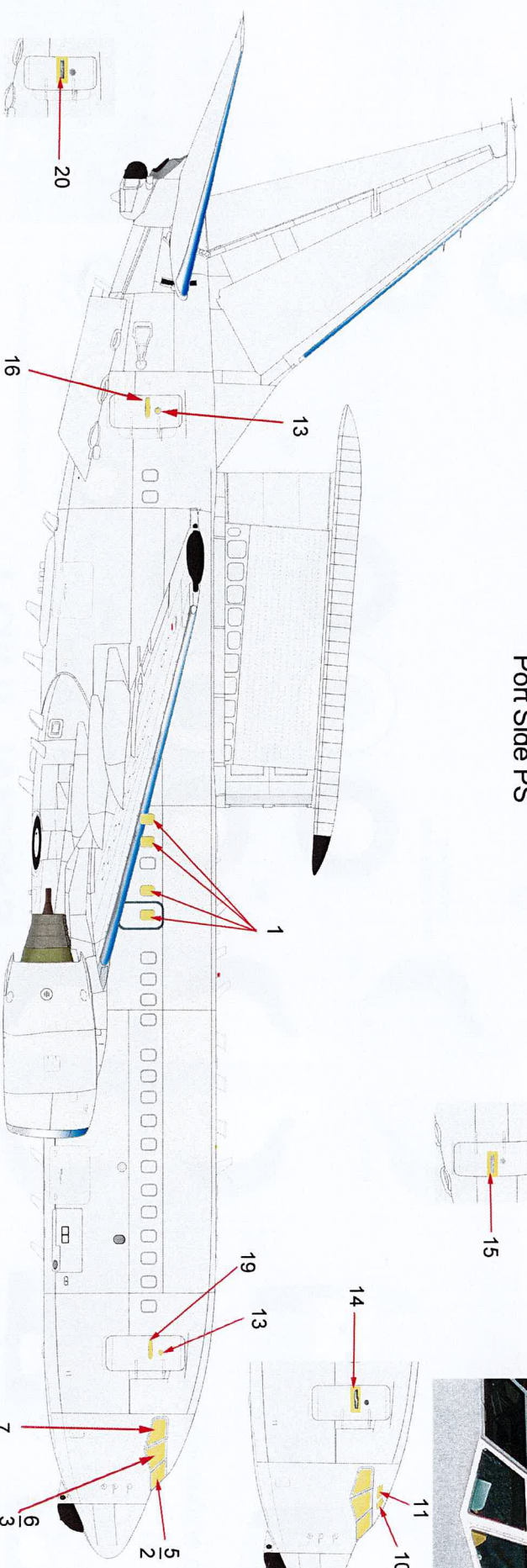
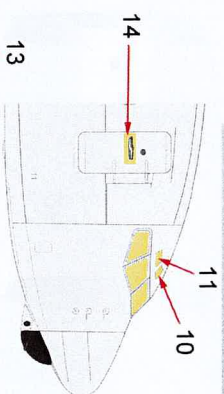

RPM-048 737-7ES Wedgetail Paint Masks for 1772 BPK Kit

737-7ES Wedgetail Paint Masks

Wing Tip
ALR-2001 ESM
Bottom

Paint Masks for 1/72 BPK Kit



Front Undercarriage Wheels

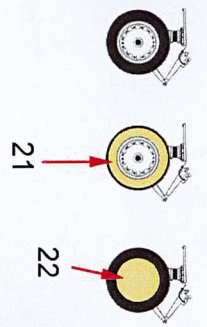

Main Undercarriage Wheels

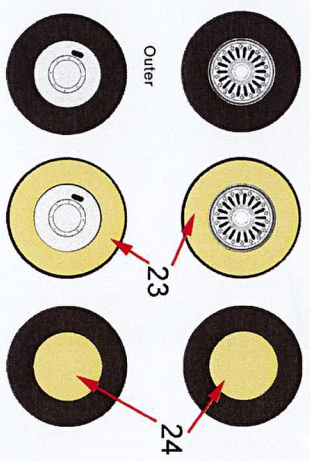

Note: ESM Kit parts are incorrect.

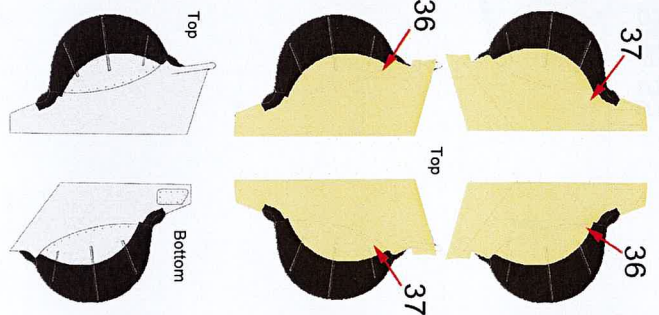

Wing Landing Lights

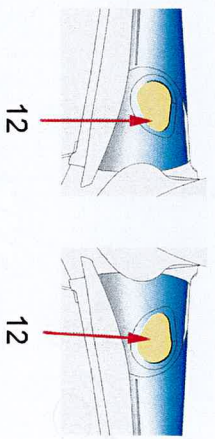

Bottom of engine cells

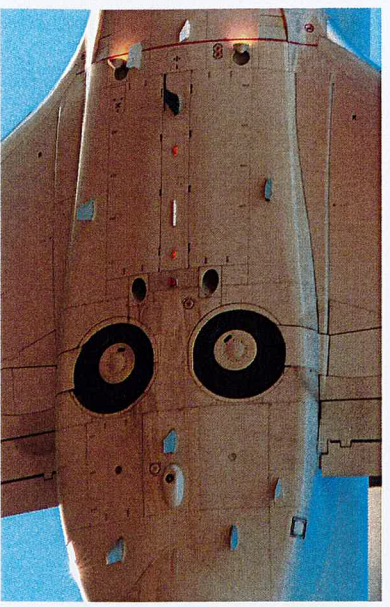
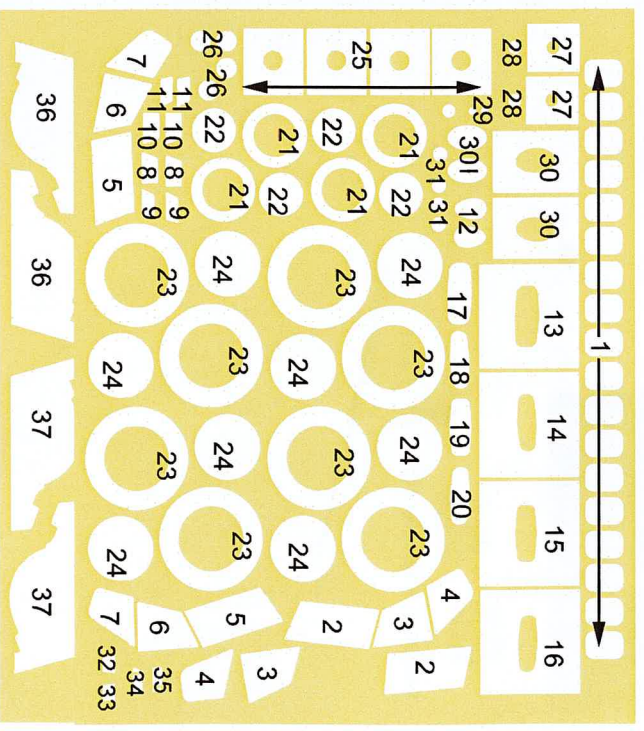
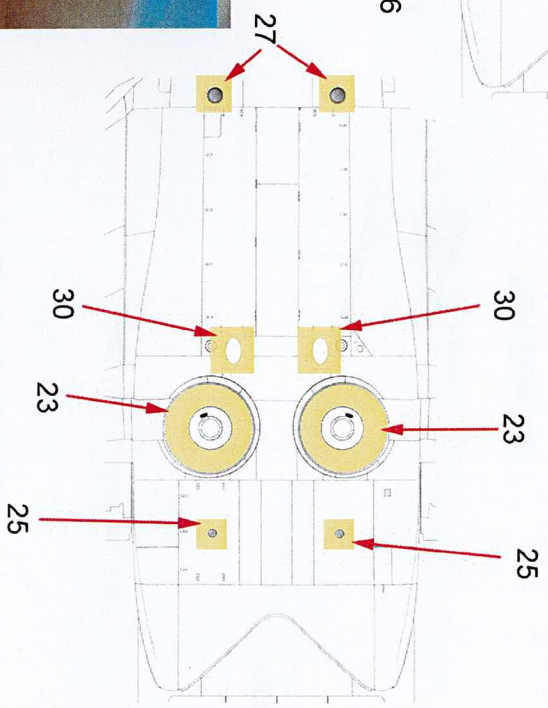
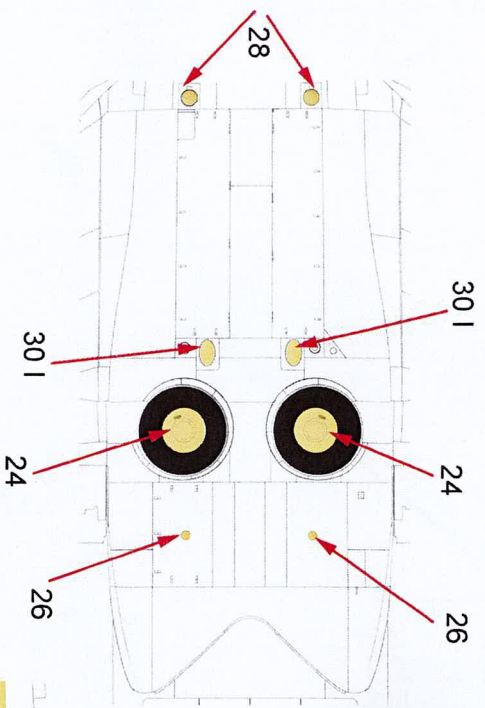
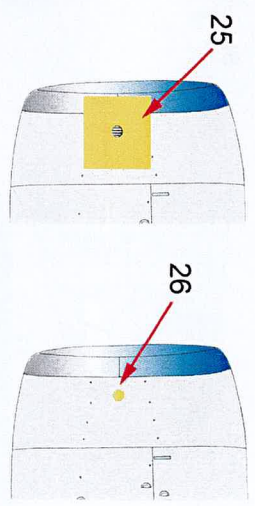

RPM-048 737-7ES Wedgetail Paint Masks for 1/72 BPK Kit



Royal Australian Air Force

BOEING 737-7ES AEW WEDGETAIL

2 Squadron AEW&C
 TESTING AND DELIVERY
 2004 - 2009

Note: Decal 69, This static port was only on the 001 when first delivered.

001 had these Clear windows when first delivered.

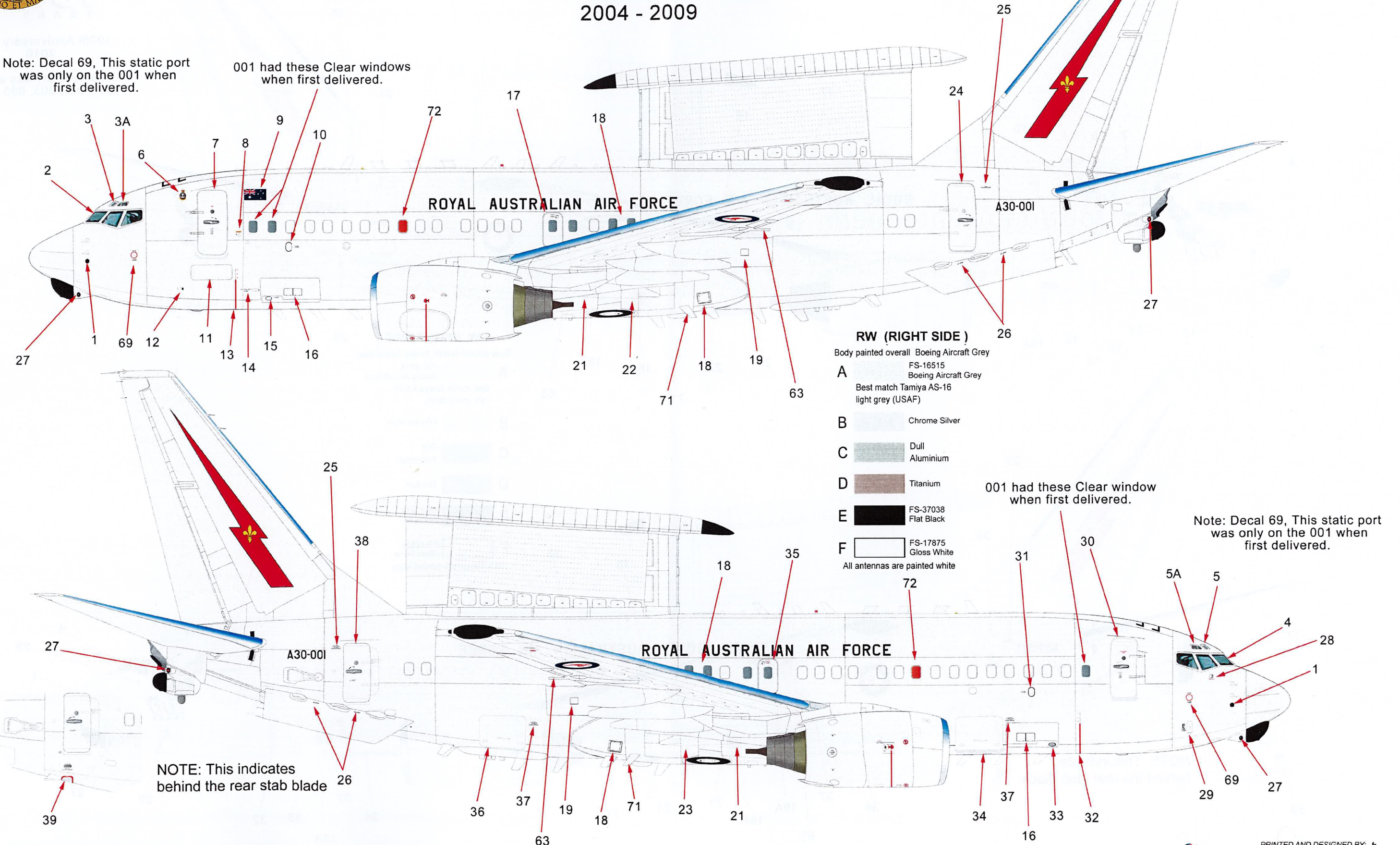

RW (RIGHT SIDE)

Body painted overall Boeing Aircraft Grey

A FS-16515 Boeing Aircraft Grey
 Best match Tamiya AS-16 light grey (USAF)

B Chrome Silver

C Dull Aluminium

D Titanium

E FS-37038 Flat Black

F FS-17875 Gloss White
 All antennas are painted white

001 had these Clear window when first delivered.

Note: Decal 69, This static port was only on the 001 when first delivered.

NOTE: This indicates behind the rear stab blade



Royal Australian Air Force

BOEING 737-7ES AEW WEDGETAIL

2 Squadron AEW&C



100th Anniversary Logo
2016

This nose art was applied
to Aircraft 003, 005 & 006.

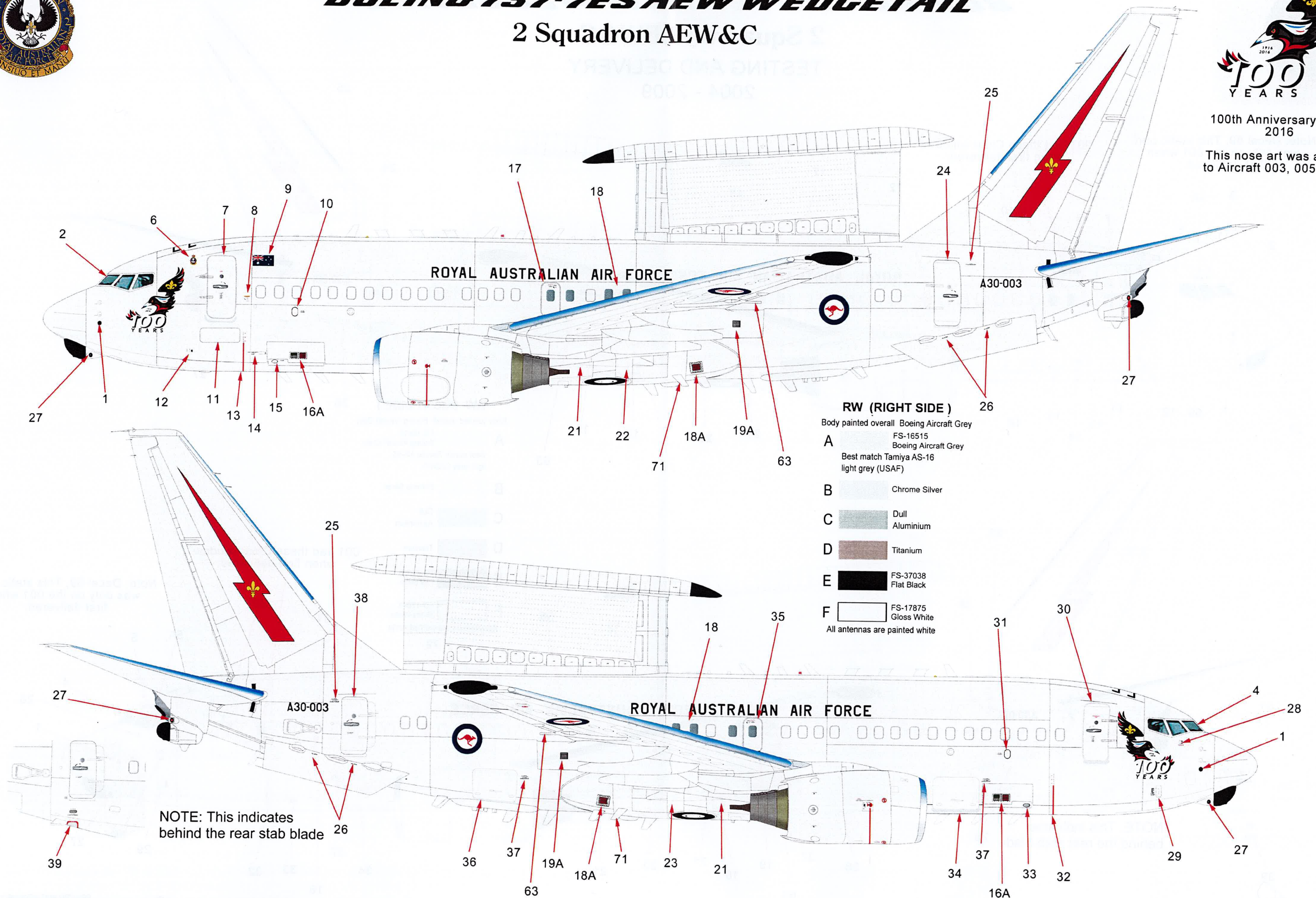

- RW (RIGHT SIDE)**
- Body painted overall Boeing Aircraft Grey
 - A** FS-16515 Boeing Aircraft Grey
Best match Tamiya AS-16 light grey (USAF)
 - B** Chrome Silver
 - C** Dull Aluminium
 - D** Titanium
 - E** FS-37038 Flat Black
 - F** FS-17875 Gloss White
All antennas are painted white

NOTE: This indicates behind the rear stab blade



Royal Australian Air Force

BOEING 737-7ES AEW WEDGETAIL

2 Squadron AEW&C



Applied to A30-001 for the 100th Anniversary of the RAF 1918 -2018

Note: Decal 69, This static port was only on the 001 when first delivered.

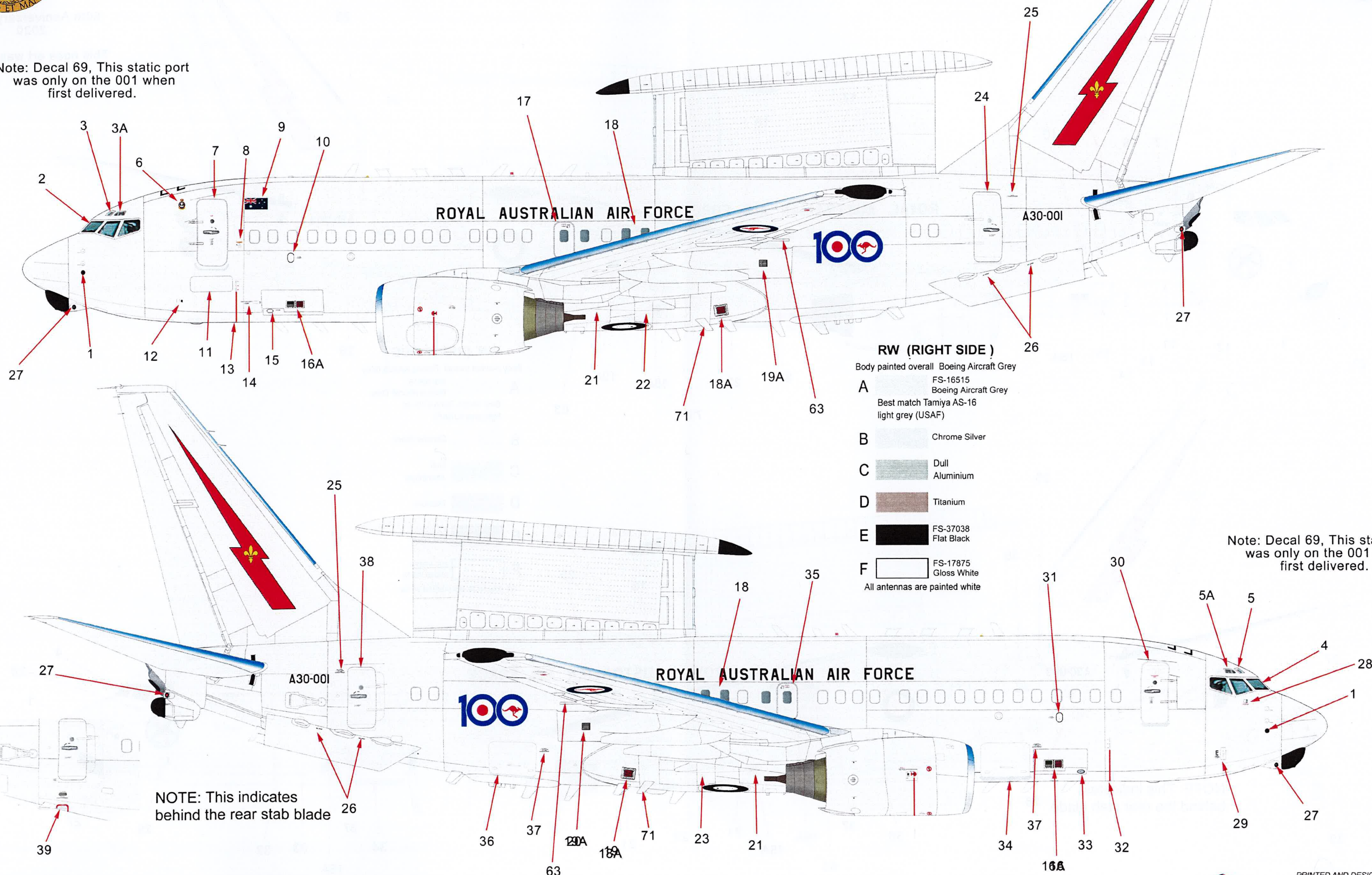

Note: Decal 69, This static port was only on the 001 when first delivered.

NOTE: This indicates behind the rear stab blade





Royal Australian Air Force

BOEING 737-7ES AEW WEDGETAIL

2 Squadron AEW&C



50th Anniversary Logo
2020

This nose art was applied
to all 6 Aircraft.

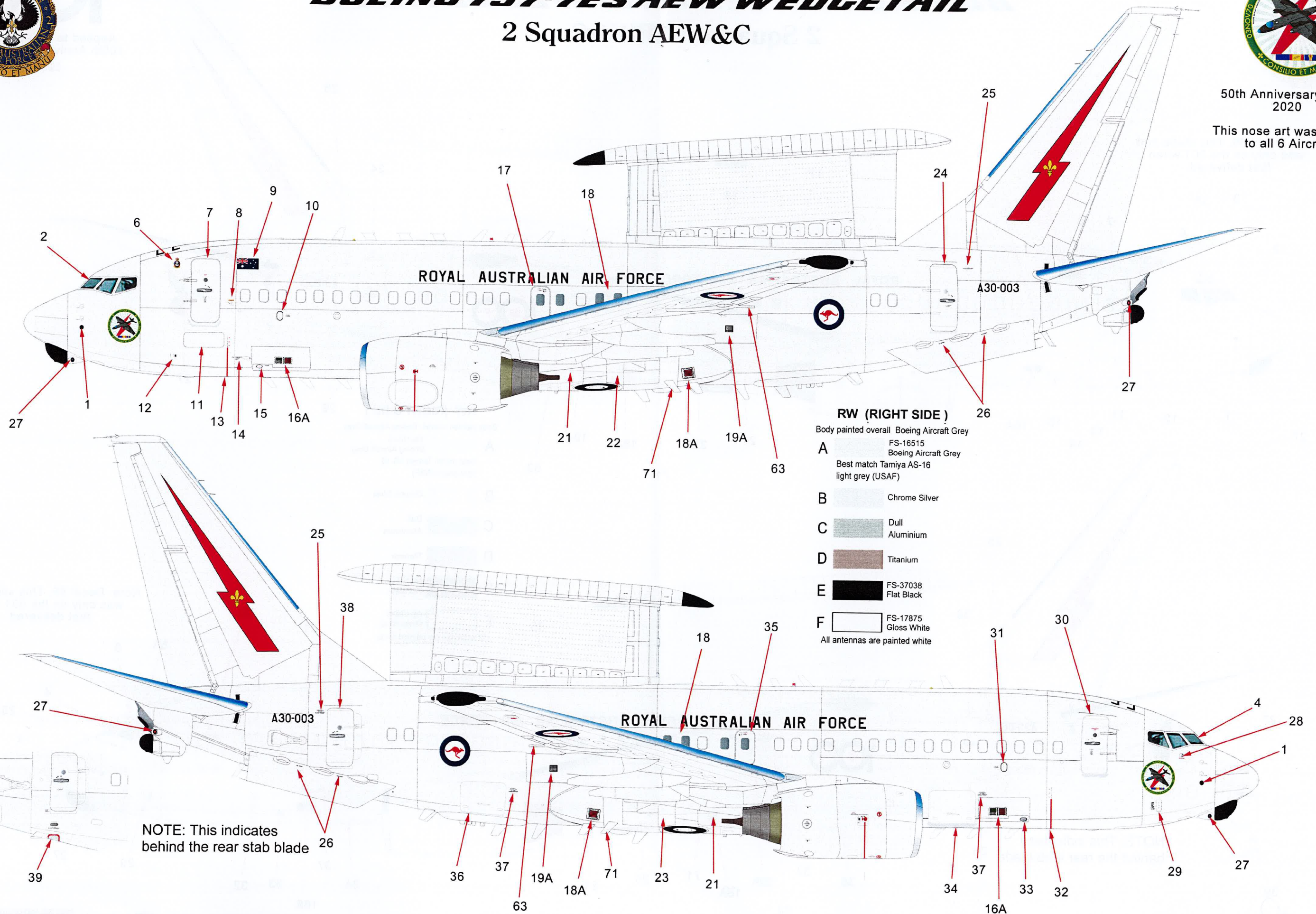

NOTE: This indicates behind the rear stab blade





Royal Australian Air Force

BOEING 737-7ES AEW WEDGETAIL

2 Squadron AEW&C



Marking the 100th Anniversary
of the RAAF
1921 -2021

This logo was applied to only
003 and 005

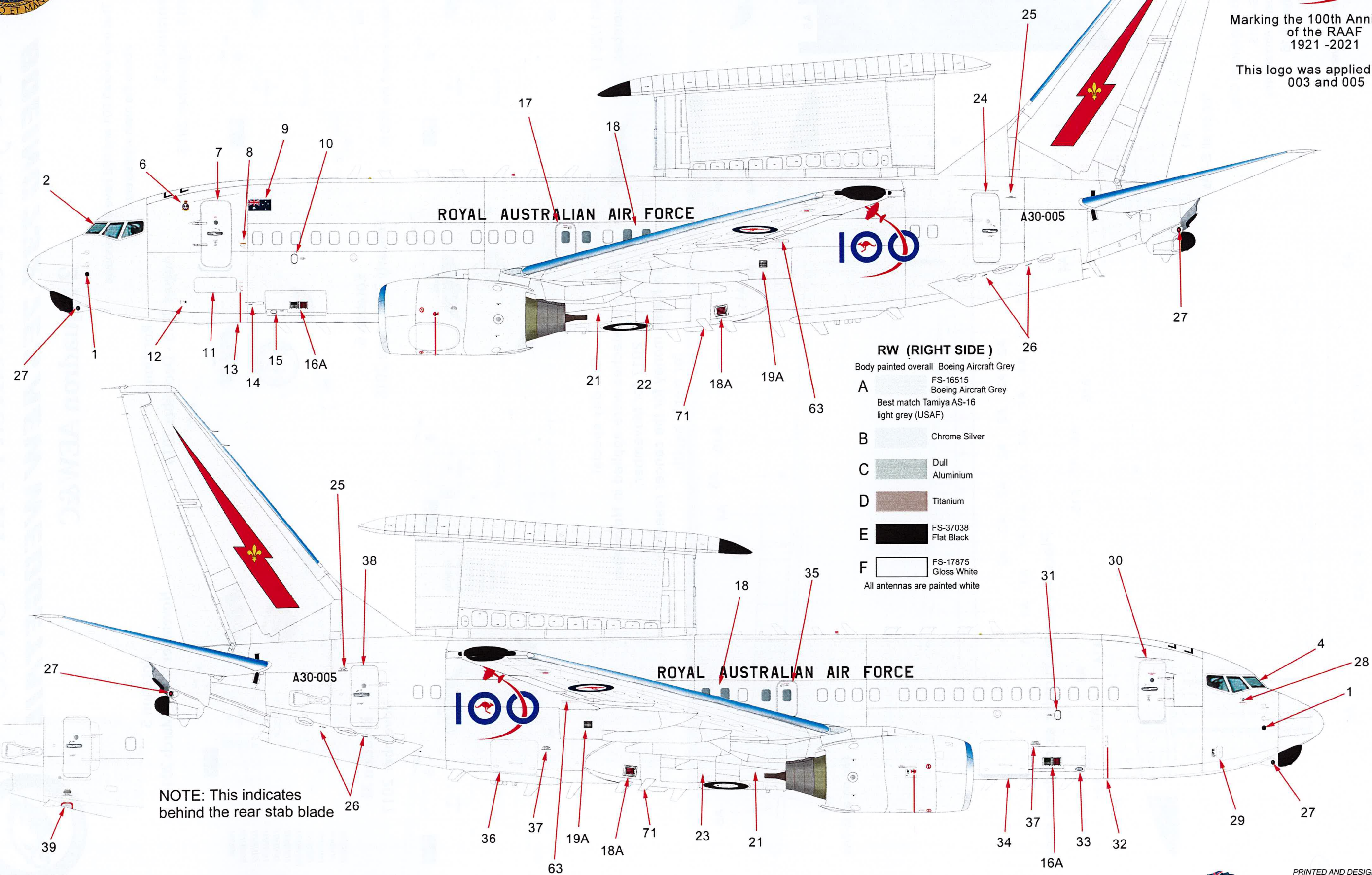



Royal Australian Air Force

BOEING 737-7ES AEW WEDGE TAIL

2 Squadron AEW&C



Note That only aircraft 001 and 002 have the windows above the main windscreen.

Rotation 2-3
February 2015 - September 2015

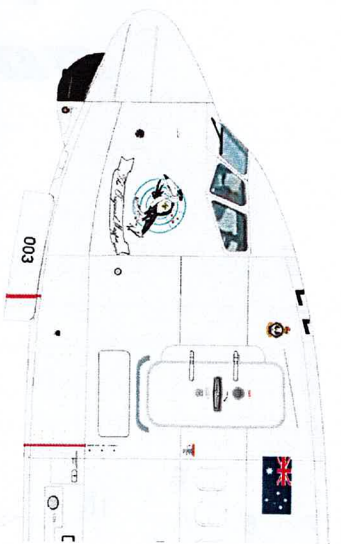

Rotation 4
August 2015 - December 2015

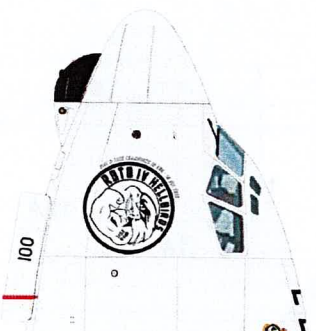

Rotation 5
November 2015 - March 2016

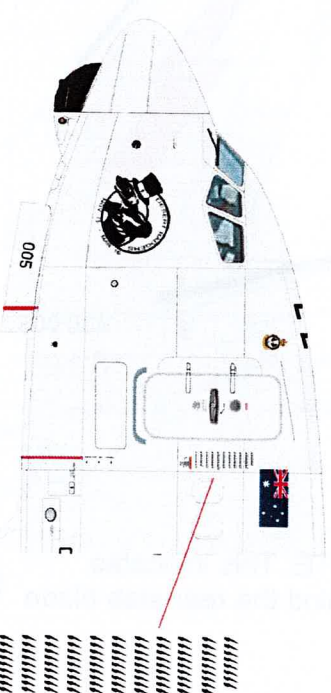

seen during the rotation around the 7/2015

Rotation 6
February 2016 - June 2016

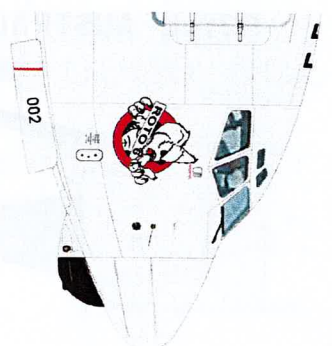

Rotation XI
November 2017

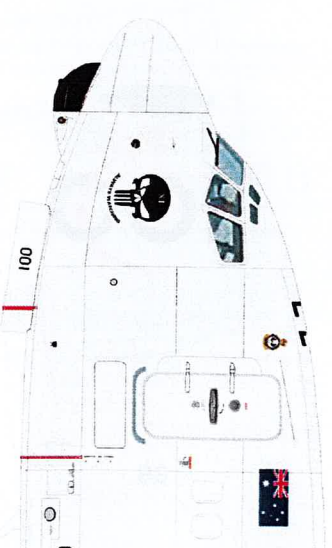
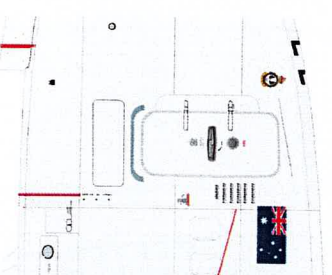

Seen 29/11/2017
For November.

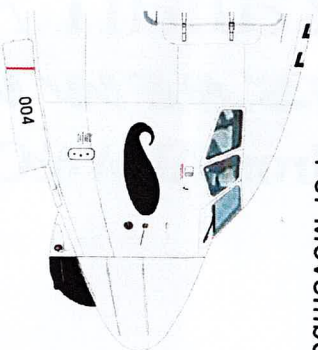

These moustaches were applied in November 2017 for November. To Raise money for the cancer research for men's health.

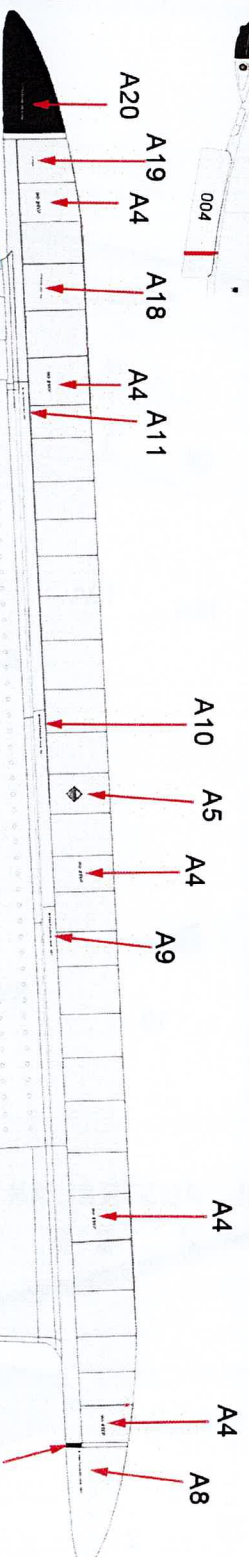
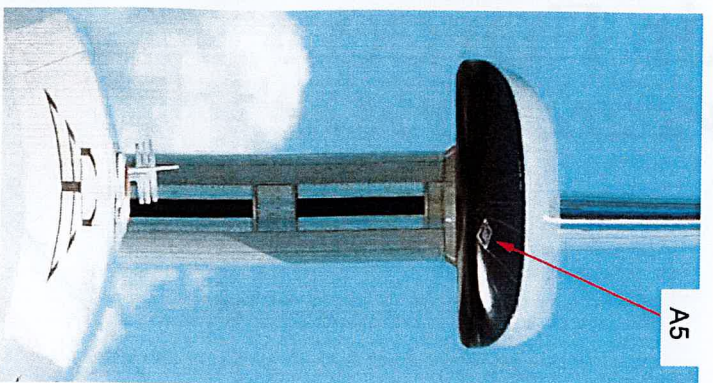
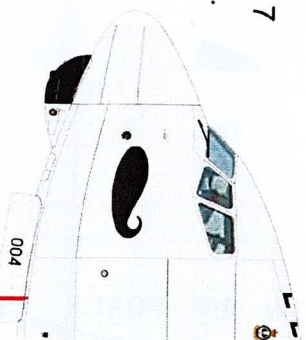

Not on all E-7As

Place A1 decals in order as on decal sheet

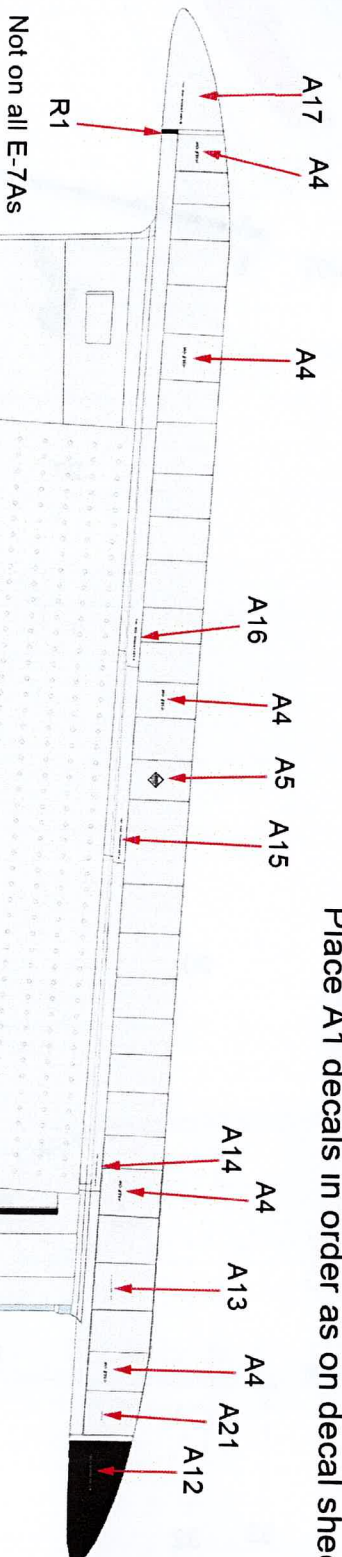

Not on all E-7As

Body painted overall Boeing Aircraft Grey

- A FS-16515 Boeing Aircraft Grey
- Best match Tamiya AS-16 light grey (USAF)

B Chrome Silver



PRINTED AND DESIGNED BY:
ROMM GRAPHS AUSTRALIA
AUSTRALIAN MADE AND OWNED.

Early 001

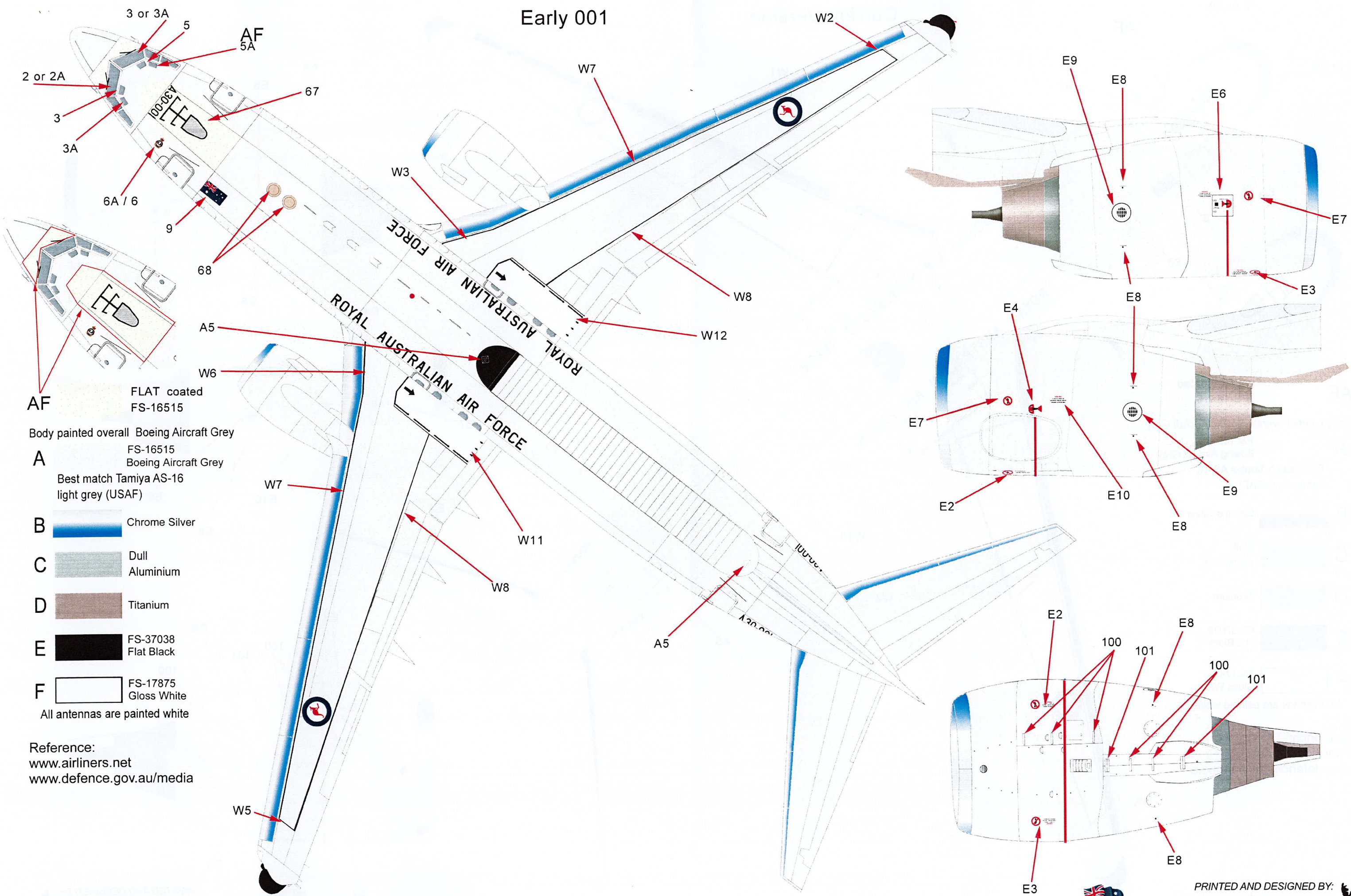

- AF FLAT coated FS-16515
 - Body painted overall Boeing Aircraft Grey FS-16515
 - A Best match Tamiya AS-16 light grey (USAF)
 - B Chrome Silver
 - C Dull Aluminium
 - D Titanium
 - E FS-37038 Flat Black
 - F FS-17875 Gloss White
- All antennas are painted white

Reference:
www.airliners.net
www.defence.gov.au/media

RDS-093 RAAF 2 SQUADRON BOEING 737 WEDGETAIL



PRINTED AND DESIGNED BY:
ROMM GRAPHICS AUSTRALIA
 AUSTRALIAN MADE AND OWNED

Current Version

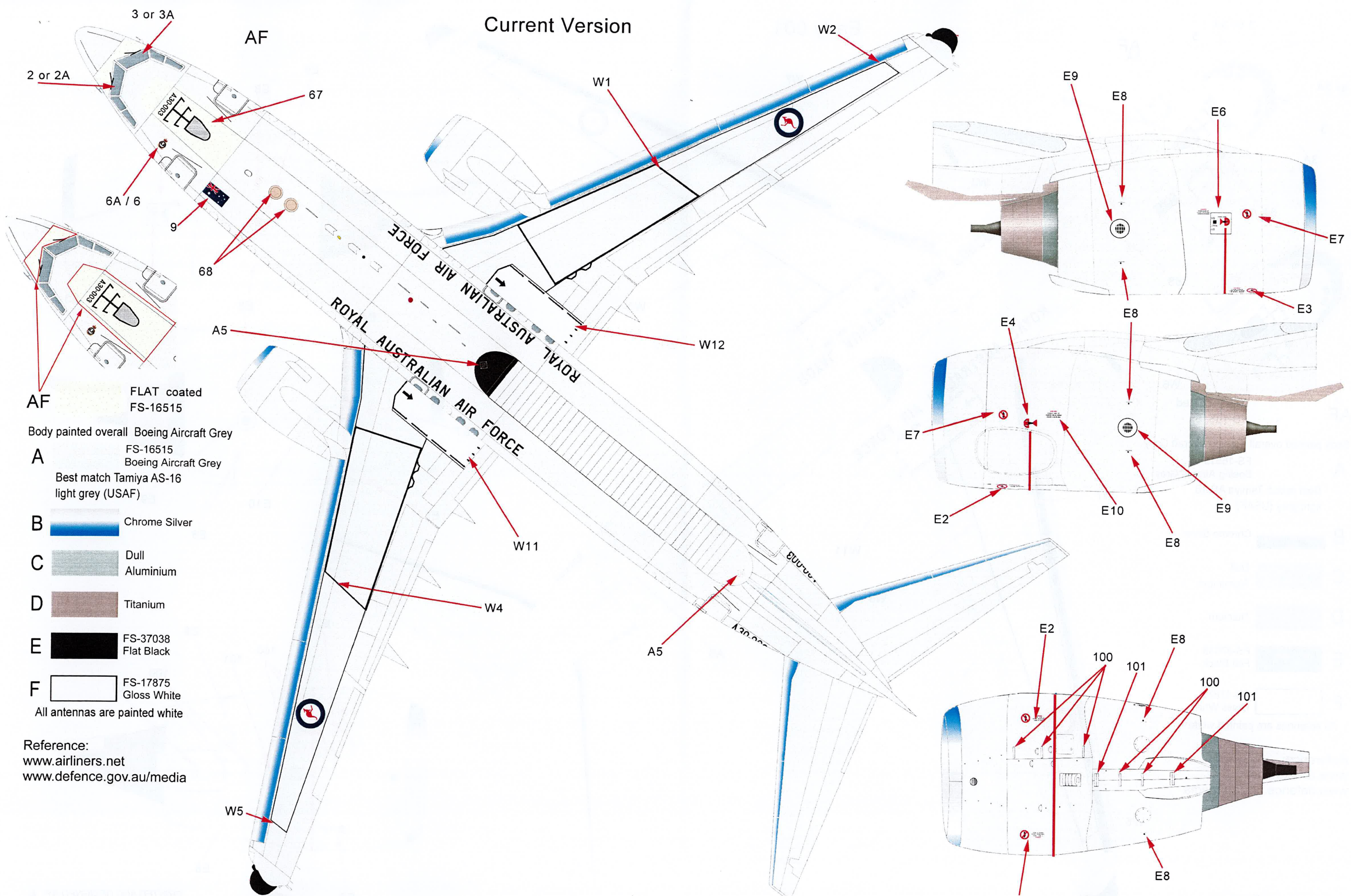

- AF FLAT coated FS-16515
- Body painted overall Boeing Aircraft Grey FS-16515
- A Boeing Aircraft Grey Best match Tamiya AS-16 light grey (USAF)
- B Chrome Silver
- C Dull Aluminium
- D Titanium
- E FS-37038 Flat Black
- F FS-17875 Gloss White
- All antennas are painted white

Reference:
www.airliners.net
www.defence.gov.au/media

RDS-093 RAAF 2 SQUADRON BOEING 737 WEDGETAIL



PRINTED AND DESIGNED BY:
ROMM GRAPHICS AUSTRALIA
 AUSTRALIAN MADE AND OWNED

Body painted overall Boeing Aircraft Grey

A  FS-16515
Boeing Aircraft Grey
Best match Tamiya AS-16
light grey (USAF)

B  Chrome Silver

C  Dull
Aluminium

D  Titanium

E  FS-37038
Flat Black

F  FS-17875
Gloss White

All antennas are painted white

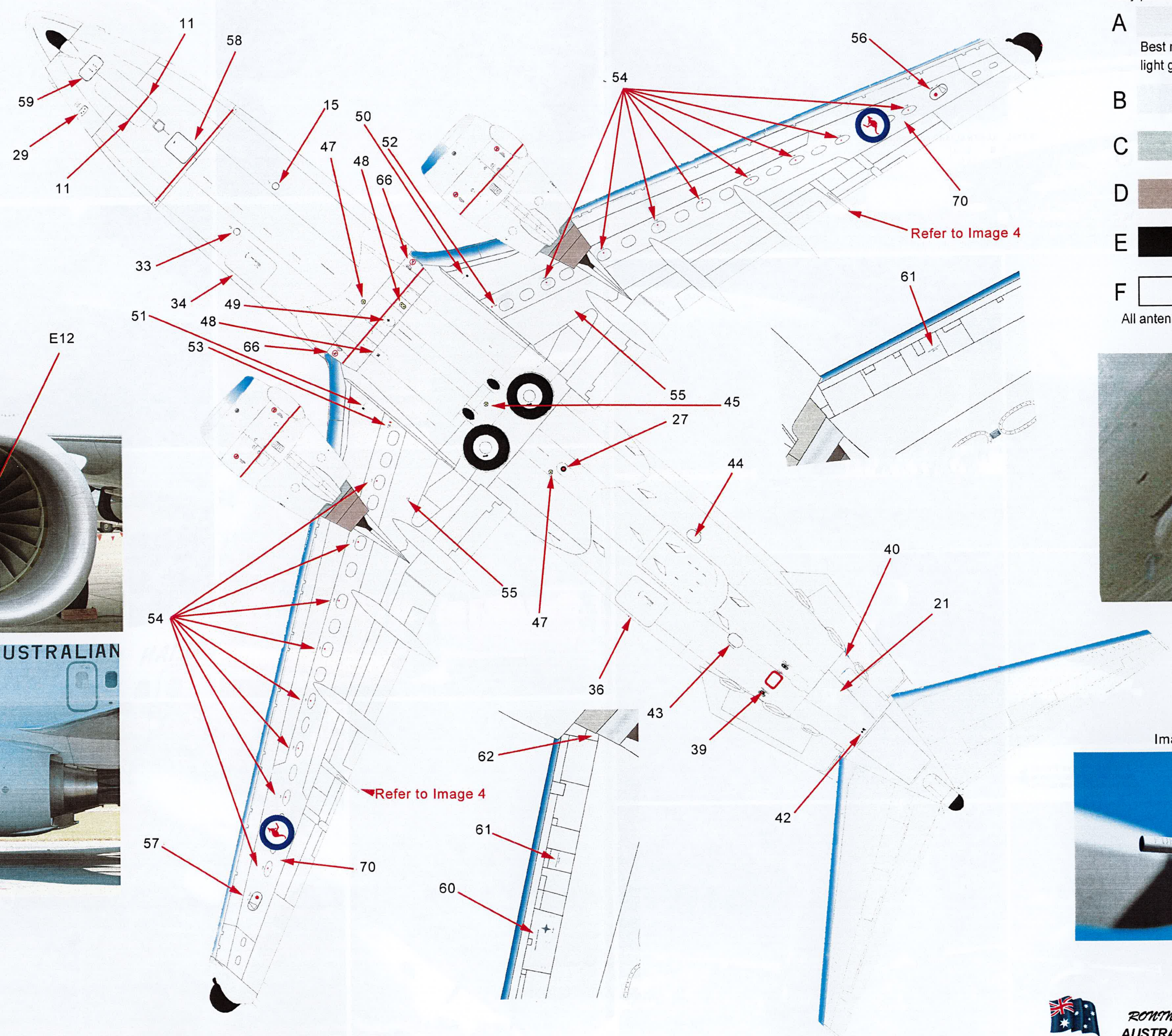

Photo's by Steven Evans

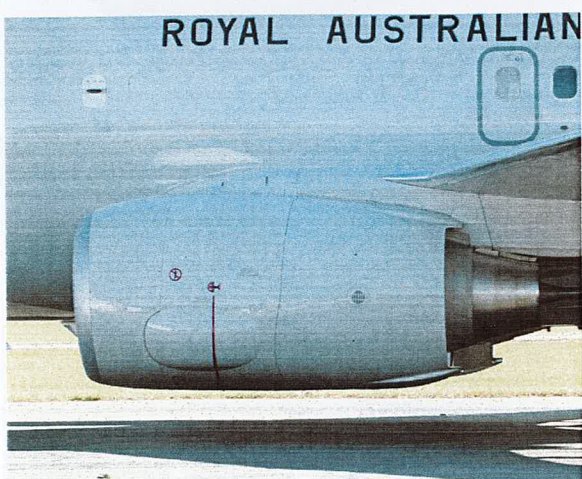

Image 4 decals 63



RDS-093 RAAF 2 SQUADRON BOEING 737 WEDGETAIL



PRINTED AND DESIGNED BY:
ROMY GRAPHICS AUSTRALIA
AUSTRALIAN MADE AND OWNED

Images by: Steven Evans
/ RAAF

Royal Australian Air Force

BOEING 737-7ES AEW WEDGETAIL

2 Squadron AEW&C

Photo By: Steve Evans
ROYAL AUSTRALIAN AIR FORCE
AUSTRALIAN MADE AND OWNED



Photo By: Steve Evans
ROYAL AUSTRALIAN AIR FORCE
AUSTRALIAN MADE AND OWNED

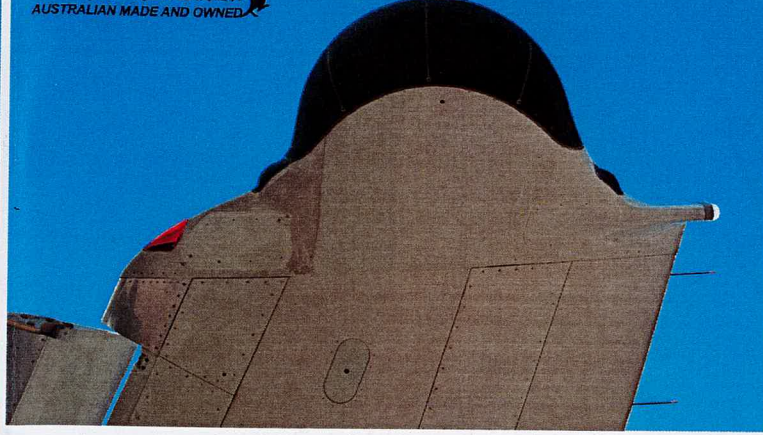

Photo By: Steve Evans
ROYAL AUSTRALIAN AIR FORCE
AUSTRALIAN MADE AND OWNED



Photo By: Steve Evans
ROYAL AUSTRALIAN AIR FORCE
AUSTRALIAN MADE AND OWNED



Photo By: Steve Evans
ROYAL AUSTRALIAN AIR FORCE
AUSTRALIAN MADE AND OWNED



Photo By: Steve Evans
ROYAL AUSTRALIAN AIR FORCE
AUSTRALIAN MADE AND OWNED

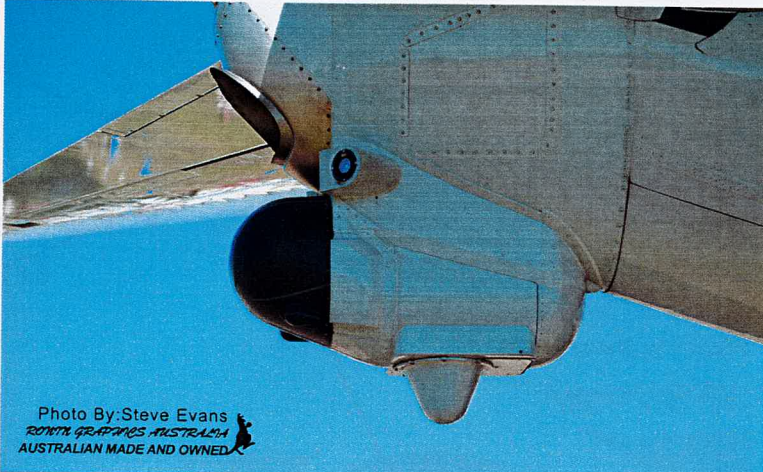
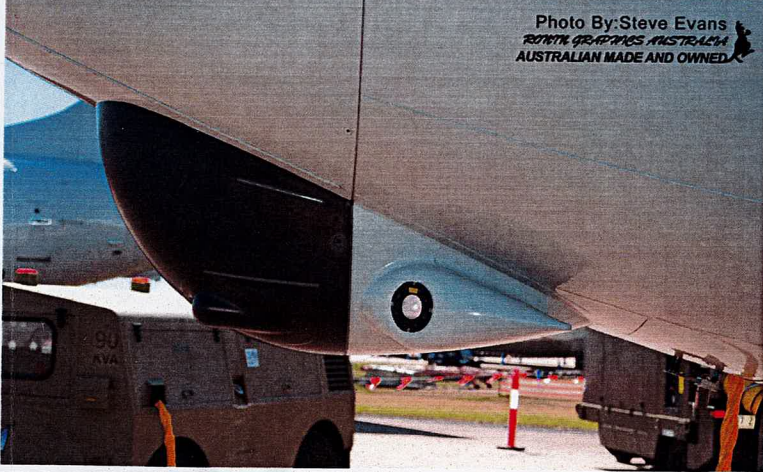

Photo By: Steve Evans
ROYAL AUSTRALIAN AIR FORCE
AUSTRALIAN MADE AND OWNED



Photo By: Steve Evans
ROYAL AUSTRALIAN AIR FORCE
AUSTRALIAN MADE AND OWNED



Photo By: Steve Evans
ROYAL AUSTRALIAN AIR FORCE
AUSTRALIAN MADE AND OWNED



Photo By: Steve Evans
ROYAL AUSTRALIAN AIR FORCE
AUSTRALIAN MADE AND OWNED

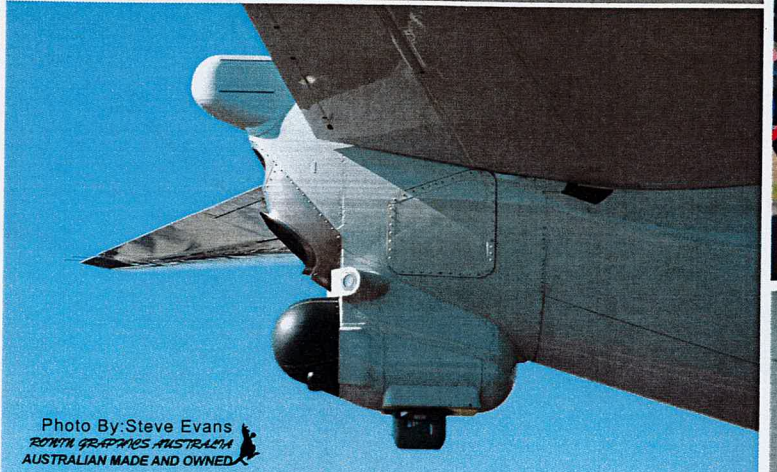

Photo By: Steve Evans
ROYAL AUSTRALIAN AIR FORCE
AUSTRALIAN MADE AND OWNED



Photo By: Steve Evans
ROYAL AUSTRALIAN AIR FORCE
AUSTRALIAN MADE AND OWNED



Photo By: Steve Evans
ROYAL AUSTRALIAN AIR FORCE
AUSTRALIAN MADE AND OWNED



Photo By: Steve Evans
ROYAL AUSTRALIAN AIR FORCE
AUSTRALIAN MADE AND OWNED

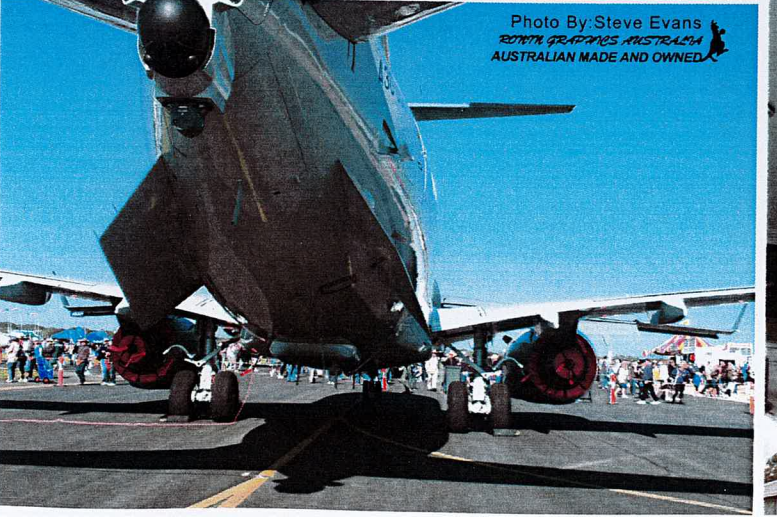
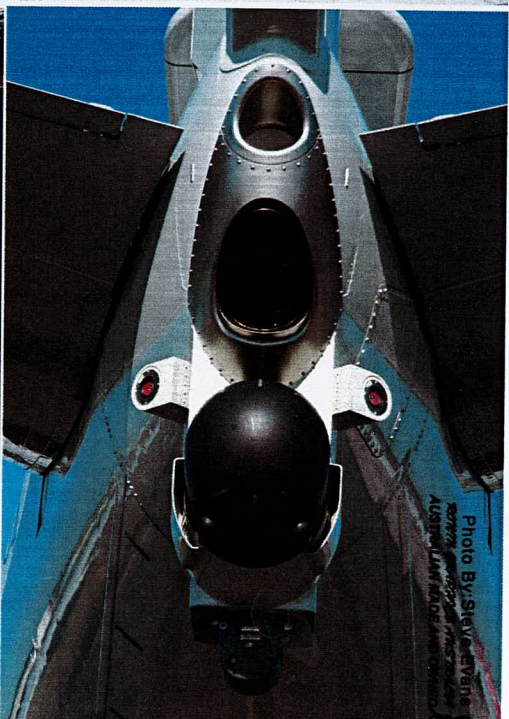
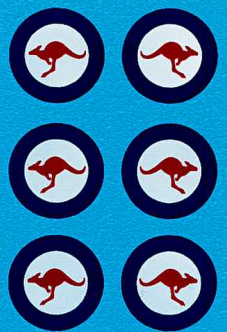
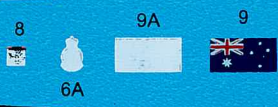
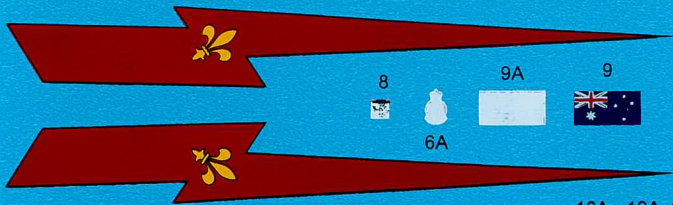

Photo By: Steve Evans
ROYAL AUSTRALIAN AIR FORCE
AUSTRALIAN MADE AND OWNED





32 13 E4 E5 E6 39 1 27 16A 19A 18A

40 E10 70 16 19 18

49 48 E7 71 52 54 55

E2 E3 E8 E11 47 46 45 11 53 54 55

17 18 10 28 21 22 23 A1 26

31 29 12 51 A2 26

33 15 42 A3 A4

69 25 37 50 A6 A10 A14 A18

44 14 42 A7 A11 A15 A19

72 4A 2A A8 A12 A16 A20

5A 5 3 3A 4 2 A9 A13 A17 A21

001 002 003 004 005 006 A5

001 002 003 004 005 006

A30-001 A30-001 A30-002 A30-003

A30-001 A30-002 A30-003

68 A30-001 A30-002 A30-003

● A30-004 A30-005 A30-006

● A30-004 A30-005 A30-006

ROYAL AUSTRALIAN AIR FORCE 002 005

ROYAL AUSTRALIAN AIR FORCE

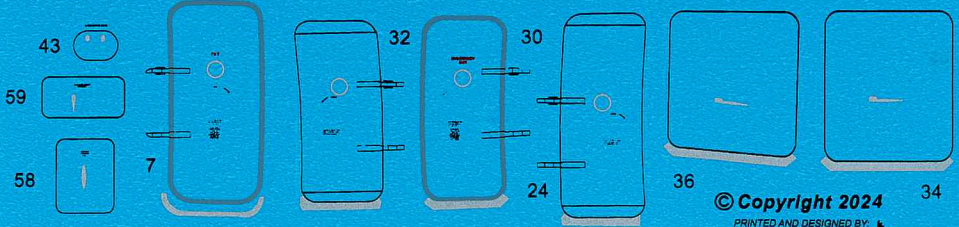

172 Boeing 737-BBJ / 737-E-7A Wedgetail Wing Walk

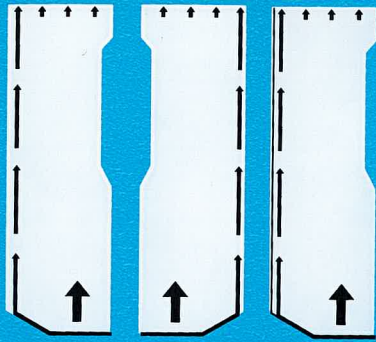

W15

W14

W12



W11

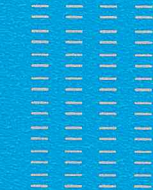

100

101



E12

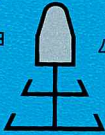

67



11



E9



W8

W9

R1



W6 W3

W7

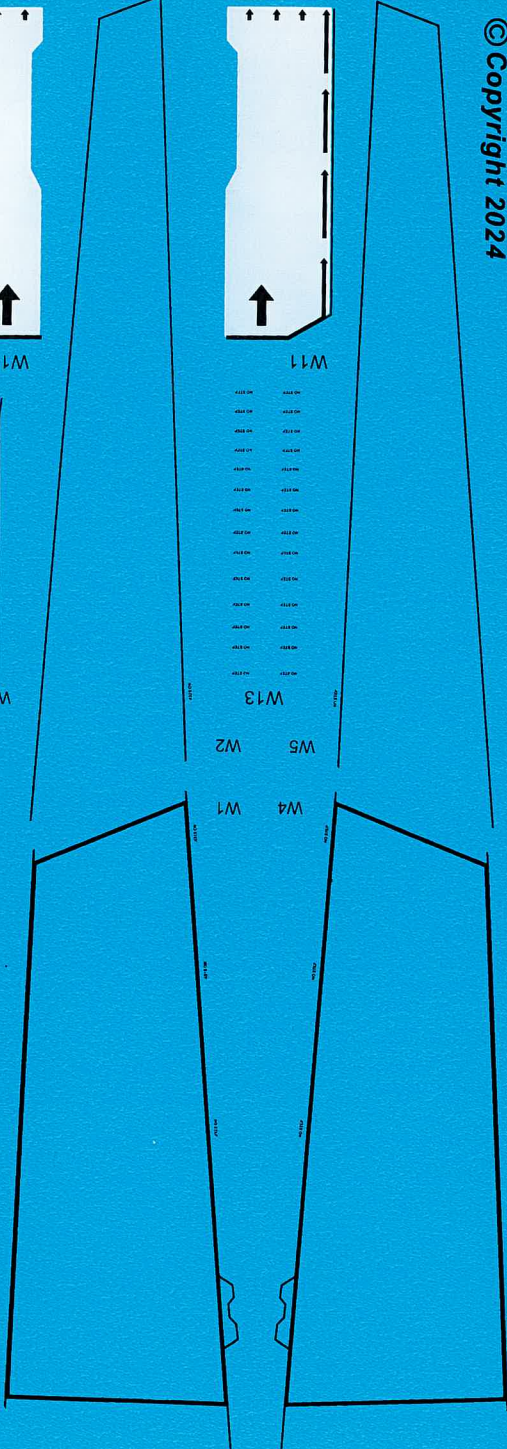

W13

W5 W2

W4 W1

W3

W6

W7

