

1/35 MILITARY MINIATURE VEHICLE UPGRADE SERIES PE35213







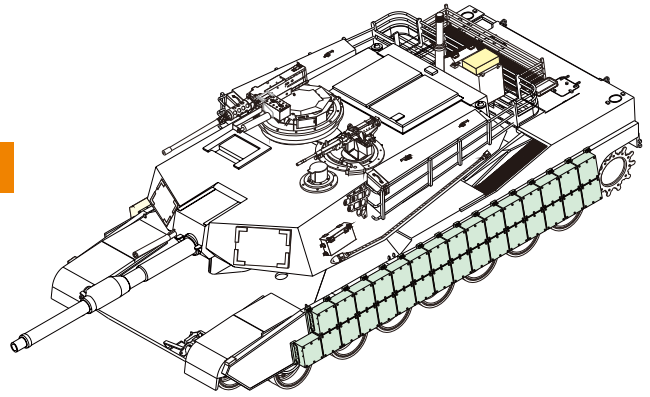
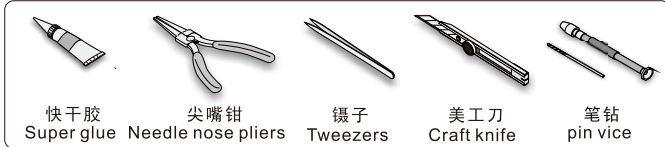

Modern US Army M1A2 Abrams Reactive Armour Module

现代美军M1A2反应装甲改造件

[For DRAGON 3536]

推荐使用工具 RECOMMENDED TOOLS



- 
安装
install
- 
折叠
bend
- A1**
改造件零件编号
PE/resin part number
- B12**
原零件编号
kit part number
- C22**
被替换的原零件编号
replaced kit part number
- 
 另一侧相同制作
repeat on opposite side
- 
切除
remove
- 
打磨
grind off
- 
弧度卷曲
radial bending
- x2**
制作若干组
multiple assembly
- 
选择安装
alternative
- 
钻孔
drill
- 
用胶棒制作
make from plastic rod

 用尖端在凹槽处冲压
use penpoint to press on the dent

蚀刻片零件内侧面向上
Put the part upside down
用笔尖在凹槽处刺
Use penpoint to press on the dent

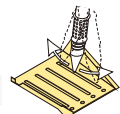
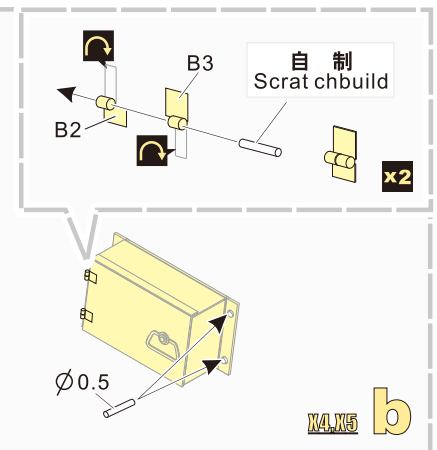
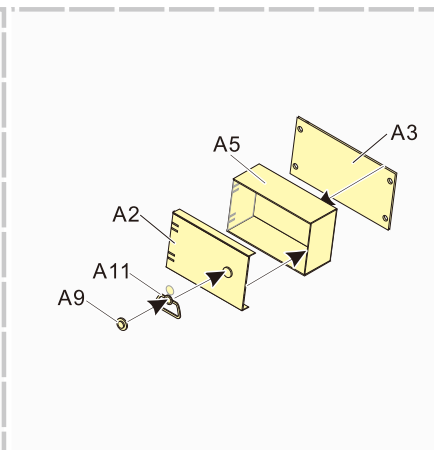
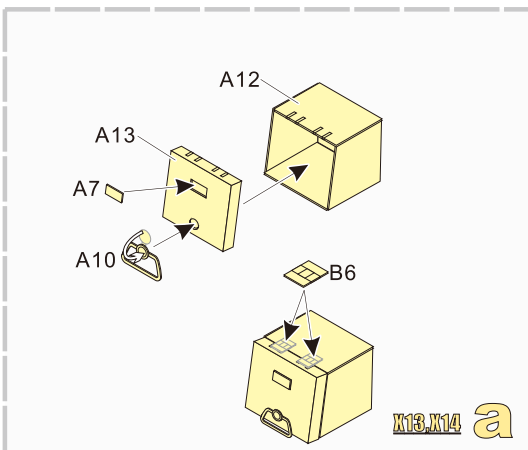
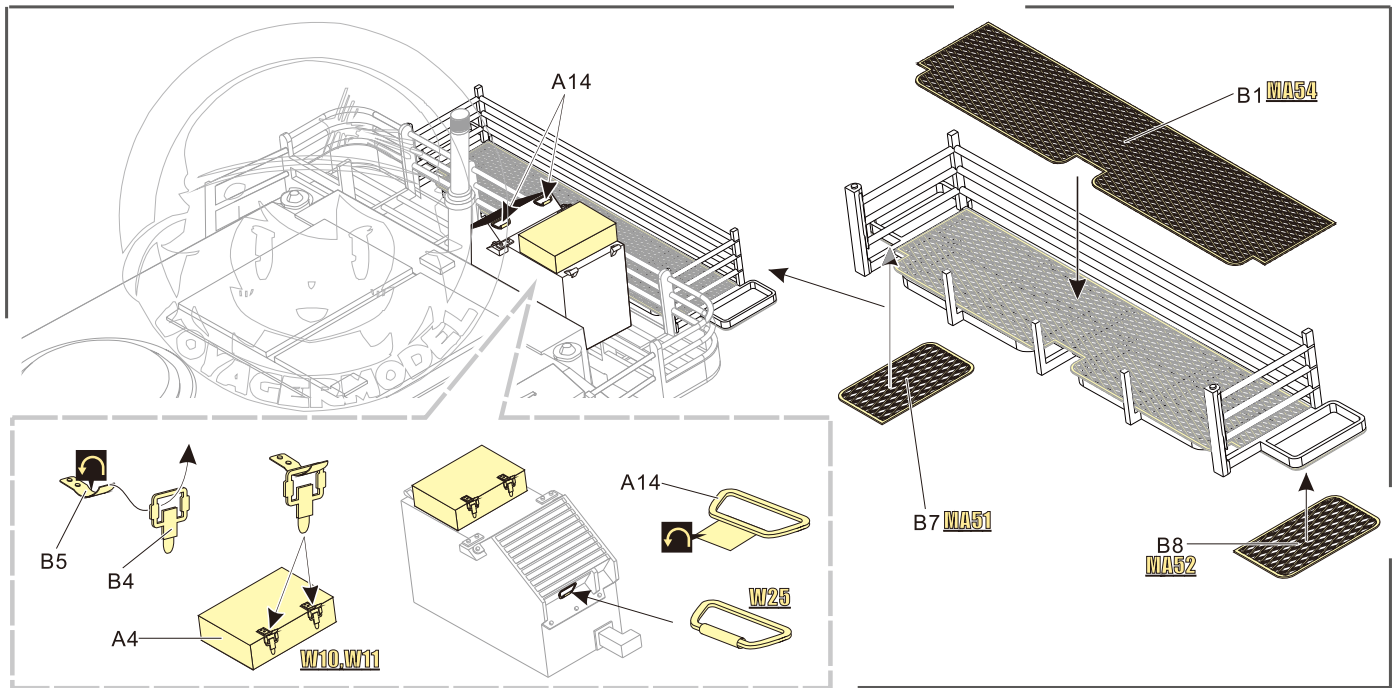
1/35 MILITARY MINIATURE VEHICLE UPGRADE SERIES PE35213

