

Spitfire F/FR Mk XIVc/e

1/32 Conversion Set for Tamiya Spitfire Mk VIII/IX "High Back"

Laminar Flow Design
 Email : info@laminarflowdesign.com
www.laminarflowdesign.com



- Working with 3D printed parts.
 - o Removal of the supports: Parts are printed into an enclosed cage that protects them in the different stages of production, transport and storage. Please cut the 4 pillars at their base on the corners and clean up the remaining mesh to access the parts. Then you can remove the parts from their support, starting by the most accessible on the sides and working your way to the center. Work support by support, using razor saw or new scalpel blade.
 Avoid snapping the part off its supports as it could damage the part in the process.
 - o Outer fuselage surfaces (ie: Sides of the cowling) might need Surfacer and sanding work for optimal result. Please try to avoid filling small rivets in the operation.
 - o Don't "force fit" parts into assembly. Cured resin is very hard, but will break under pressure.
 - o For accurate fitting, prefer trimming and sanding the plastic parts rather than resin. Plastic is easier to form and shape. But ultimately the choice is up to the builder.
 - o Washing agent residues can remain on some surfaces, fine grid sand to get rid of them
- Preparatory work
 - o Fuselage:
 - Fuselage cuts: Please refer to the image for the tail post and engine cut out. There is no template provided for these cut as they are quite straightforward, and are along the panel lines. Use razor saw for the cut, and finish with scalpel and Flat file.

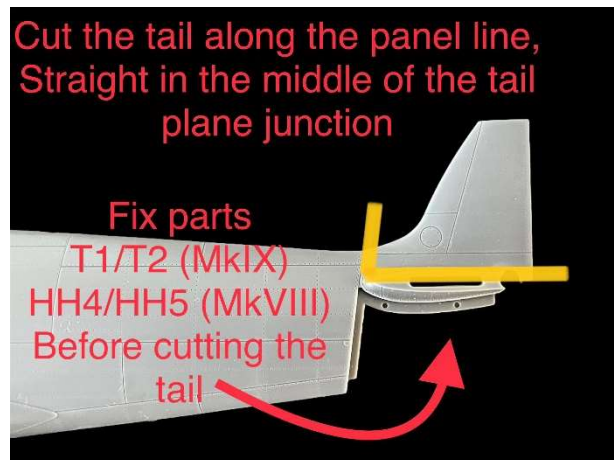
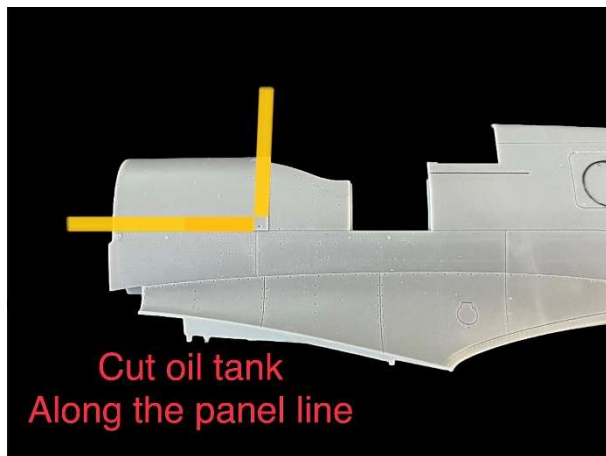

- Griffon Nose: place the windshield base template (located on Mask sheet C4) on a 0.5mm thick plastic sheet and cut a part out of it. Form it to the tank outer curve and CA glue it in the windshield recess on the resin nose. This is to ensure that the windshield part can be glued to the fuselage without CA glue and avoid fogging on the clear part.



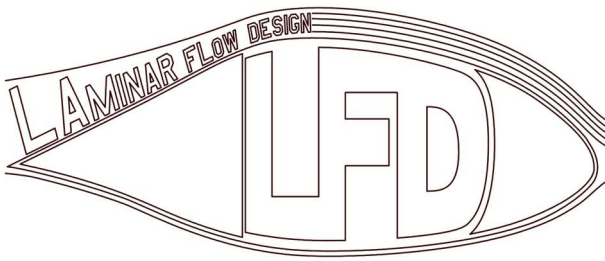

Spitfire F/FR Mk XIVc/e

1/32 Conversion Set for Tamiya Spitfire Mk VIII/IX "High Back"

Laminar Flow Design
 Email : info@laminarflowdesign.com
www.laminarflowdesign.com



- Hatches & Blisters: Refer on the version you are building. Use the corresponding template to mark the position, once satisfied, attach temporarily the template with tape. Drill multiple holes and finish with scalpel to remove the inner portion. Finish with flat and round files to conform to the template opening. Check the fit of the hatch/blister with your opening regularly, but again, don't force it into, it would break.
 - For F spitfire, add the right rear fuselage only. The port fuselage Hatch on the Tamiya fuselage needs to be filled and smoothed, prolong existing rivets lines to blend in your work. This hatch was replaced by the right rear hatch on the FXIV fuselages.
 - For FR Spitfire, Rear Starboard hatch and both blisters need to be installed, don't fill the port hatch as it was reinstalled as a part of the FR modification.

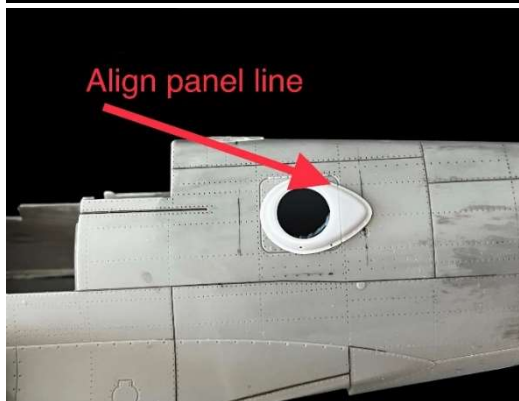
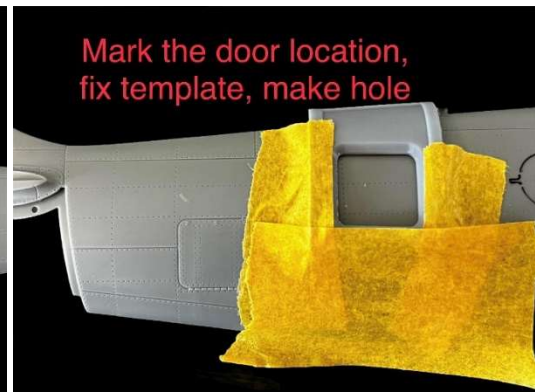
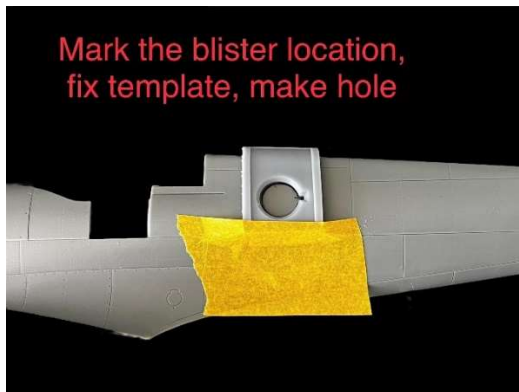

- Retractable Tail Wheel: Start with the LH side template, it slots into the rudder actuator recess on the fuselage. Fix it with tape, then fix the RH side template at the exact same height. Once happy, proceed with razor saw, scalpel and finish with flat file.



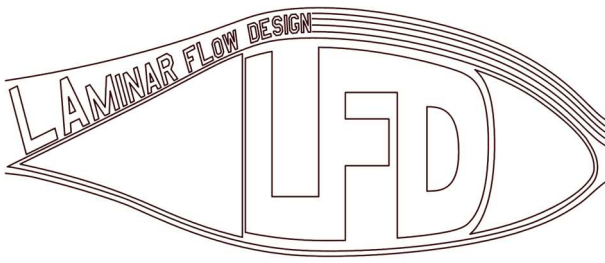

Spitfire F/FR Mk XIVc/e

1/32 Conversion Set for Tamiya Spitfire Mk VIII/IX "High Back"

Laminar Flow Design
 Email : info@laminarflowdesign.com
www.laminarflowdesign.com

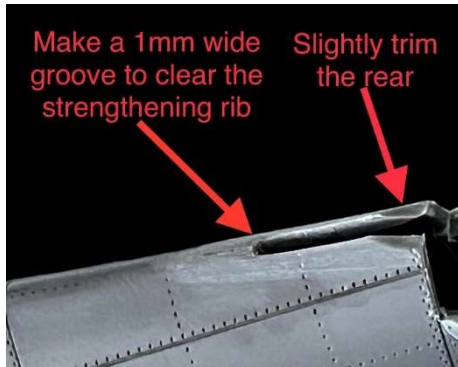

- Tail Post: With the original tail chopped off, all left is to remove material to allow for the strengthening rib on the tail post. Width of the rib is 1mm length is 11.6 mm. Check fit regularly

- Fuselage ID light: (Optional, check your subject references). Drill the pre-molded part inside the high back fuselage.



○ Wings:

- Fuel Tanks: Use templates as shown in the pictures. Mark 1st with a fine pencil, once happy with the location, fix the first template and scribe the outline with your preferred engraving tool. Then fix the 2nd template inside the first, and proceed to engrave the filling port. Sand clean and fix with a small drop of extra thin.

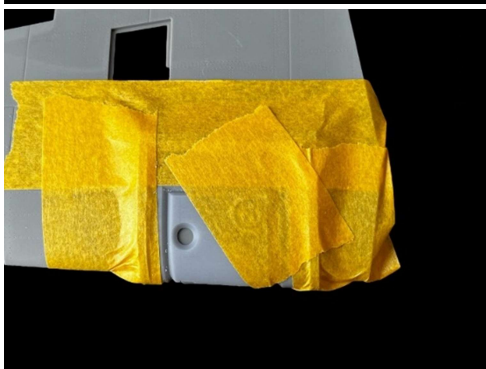
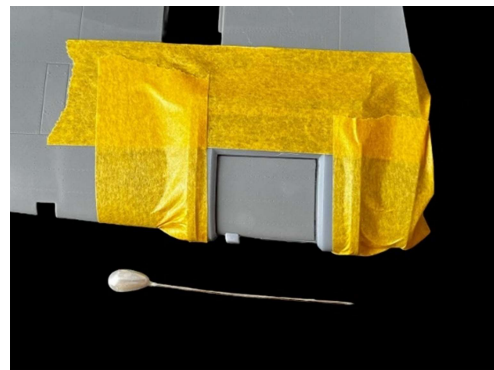

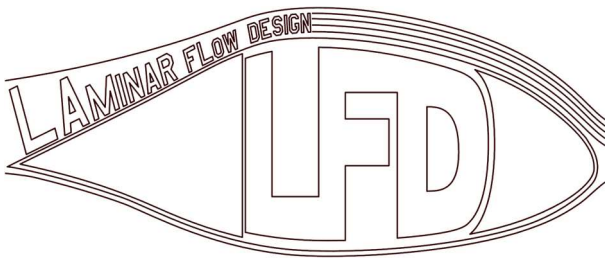

Spitfire F/FR Mk XIVc/e

1/32 Conversion Set for Tamiya Spitfire Mk VIII/IX "High Back"

Laminar Flow Design
 Email : info@laminarflowdesign.com
www.laminarflowdesign.com



Add rows of fasteners and rivets per the last picture (courtesy of MkVIII wing)

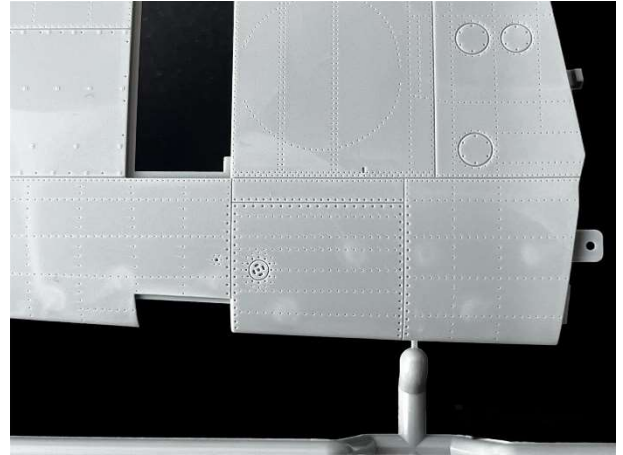
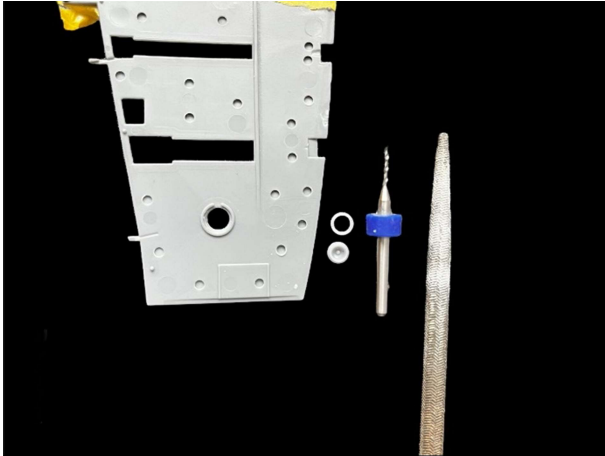

- Downward ID lights (Optional, check your subject references): Drill the pre-molded part inside the wing, finish the diameter with round file. Test fit with the assembly.

- Ailerons Shortening: Cut Parts B5/B6 at the outer line, keep cut parts to reassemble with the wings, eventually add a plastic strip along the seam to keep the alignment. putty and sand the joints to blend in the wing. See Reference pic

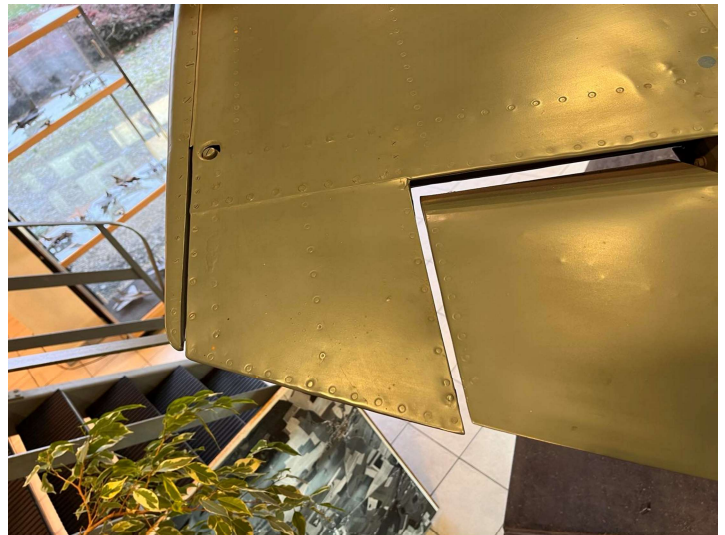

Congratulations, you have finished the preparatory work.

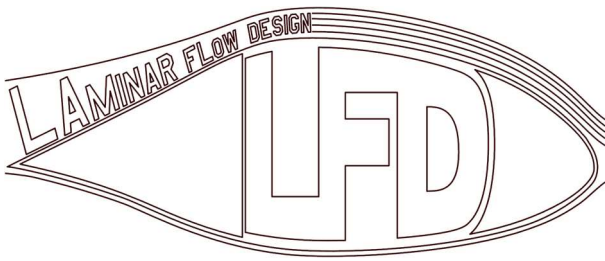

Spitfire F/FR Mk XIVc/e

1/32 Conversion Set for Tamiya Spitfire Mk VIII/IX "High Back"

Laminar Flow Design
 Email : info@laminarflowdesign.com
www.laminarflowdesign.com



- General Assembly:

- Fixation of the nose: Proceed on Step 15 on the model assembly, but omit part G6 when assembling fuselage (Check Tail post instructions when assembling the fuselage). Slide Part G6 (+G3+Polycaps) into the nose protruding pins, but don't glue it. Place the nose assembly into the assembled fuselage and place part G6 in its side locating holes. Test fit and CA glue part G6 to the resin nose (via the 2 slide pins). Hold in place and let dry.

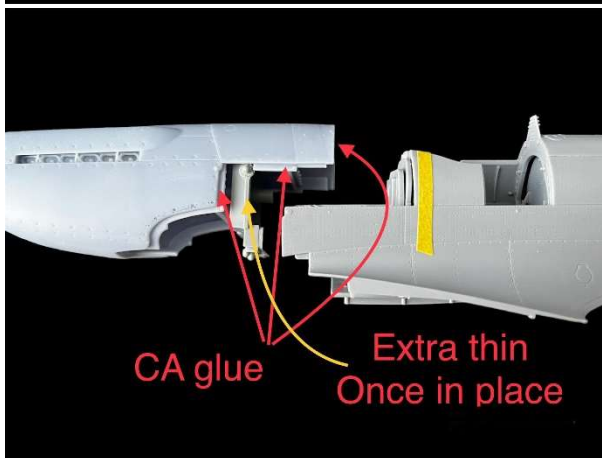

Take out the nose with affixed G6 part, apply CA glue on all contact surfaces and put the nose back in place. To Reinforce the bond, apply Extra Thin glue on the contact surface between G6 Part and fuselage.

Assembly of the nose parts: Use parts from cage 2 and 3.

Add the Spinner Counter plate at its base (Not on the below picture). Avoid Gluing the Propeller Axle, it is designed to allow turning the prop. Assemble part AA27 (provided in the box, but normally unused) to the rear of the carb intake.

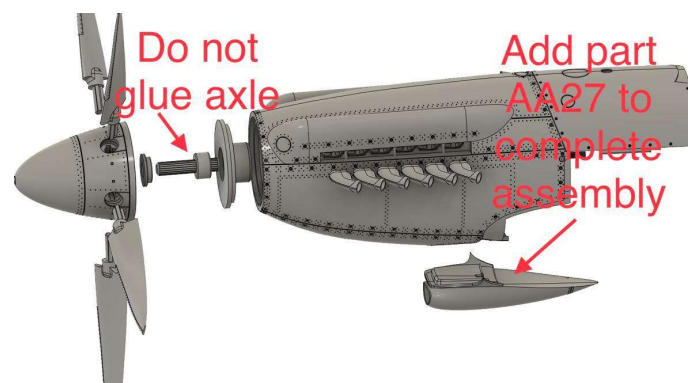
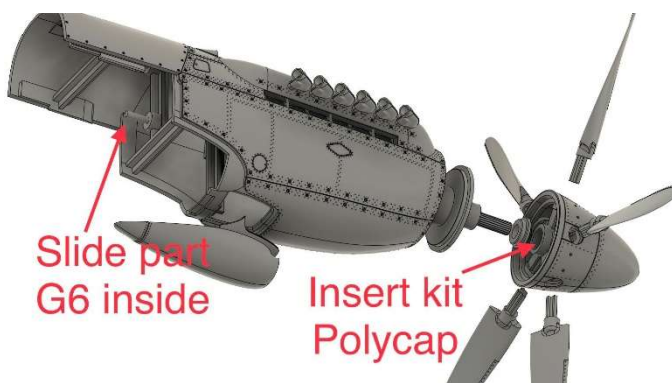

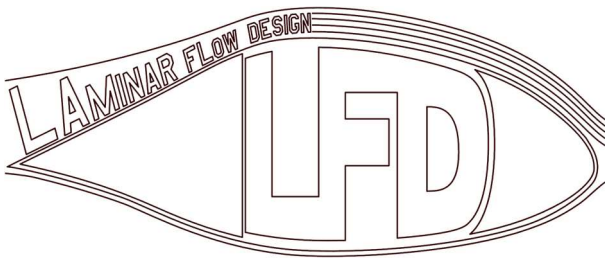

Spitfire F/FR Mk XIVc/e

1/32 Conversion Set for Tamiya Spitfire Mk VIII/IX "High Back"

Laminar Flow Design
 Email : info@laminarflowdesign.com
www.laminarflowdesign.com



- Radiators

Clean contact parts and between the 2 grills to ensure optimal fitting. Absolutely don't force them into position, again, they would break. Position the vent open or closed at your discretion.

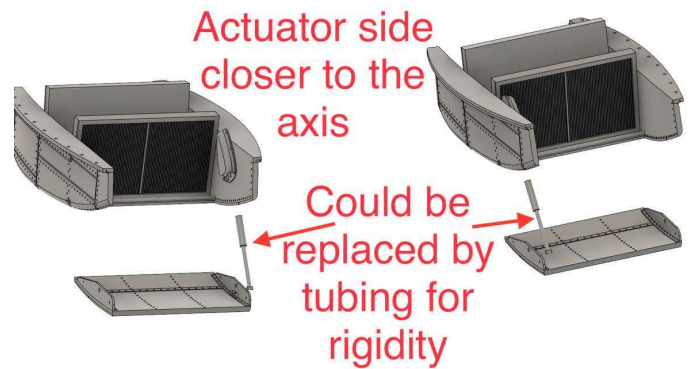

- Tail Post

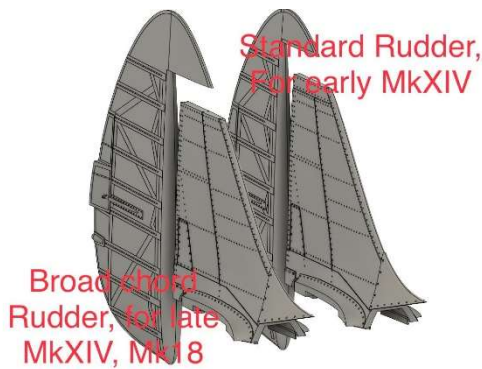

Choose between Std or enlarged rudder (check your references).

While special care has been taken to design the most fittable part as possible, the tail post assembly is a tad wider than the stock part, and thus require a few modeling skills:

The rear fuselage joint needs a bit of shimming to comply with the global width.

When assembling the fuselage, **do not** glue the fuselage part at the rudder junction (see picture).

Shim accordingly up and down to comply with the tail post and wheel well insert.

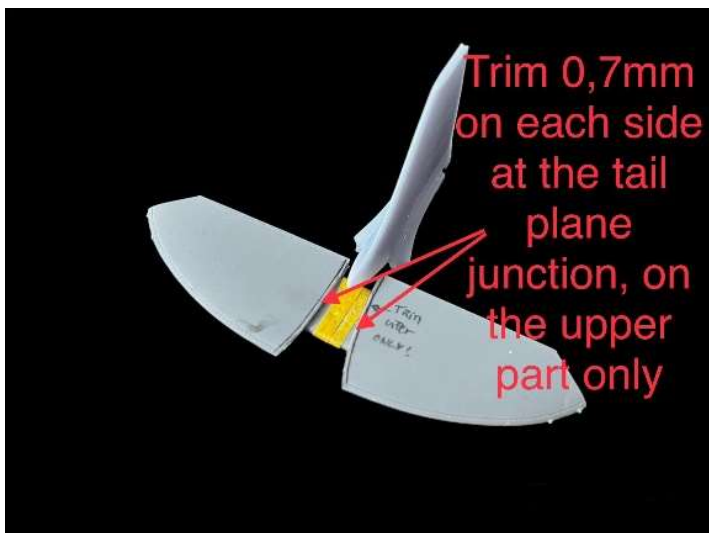

Last step, as the tail is a bit wider, there is 0.7mm to remove along the inner junction on the upper part of the horizontal tail plane. Keep the same contour. Best is to mark the line before committing to cut. See picture.

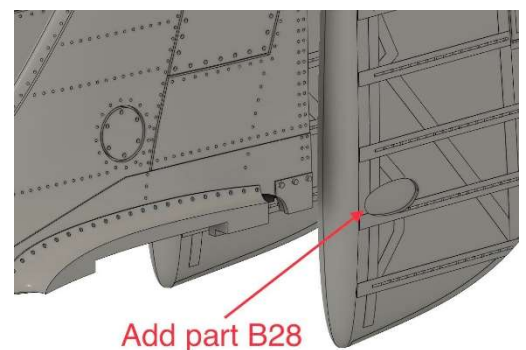

This step ensures there is a minimal gap on the underside of the tailplane.

Prepare the rudder and affix part B28 to it. But wait having shimmed the fuselage to the tail width, to fix the rudder

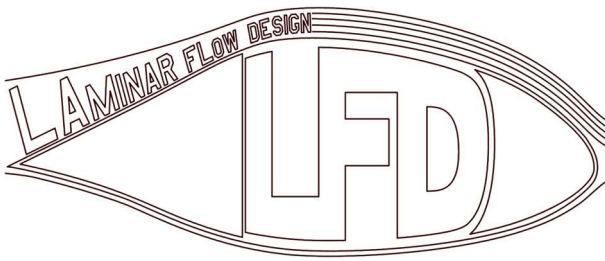

Spitfire F/FR Mk XIVc/e

1/32 Conversion Set for Tamiya Spitfire Mk VIII/IX "High Back"

Laminar Flow Design
 Email : info@laminarflowdesign.com
www.laminarflowdesign.com

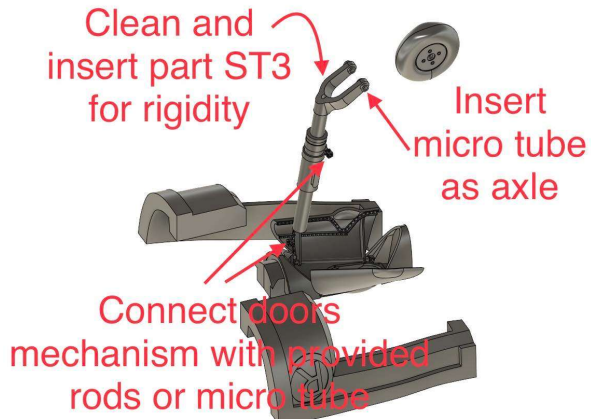

○ Retractable Tail wheel

As per picture, insert the well into the fuselage. Slide the fork into its hole. Use a 0.5mm diameter Rod to complete the wheel assembly with the fork. Add the door mechanism rod (parts provided or micro tube)

Once assembled, take extra care to not break the doors as they are very fragile.

This assembly could wait the very end of your build.

If you are starting from the VII boxing, you can assemble the kit part

- Fuselage hatch (rear RH side): Use Part Marked RR located in plate 5 (inserted in engine cage). Insert it upper side first, to clear the protruding hinge.

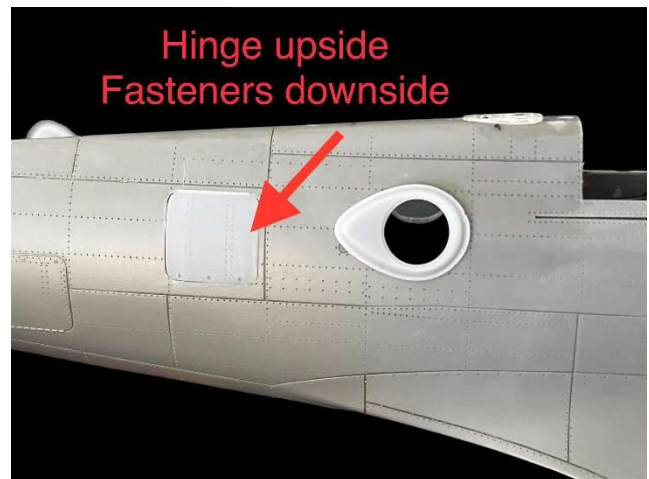
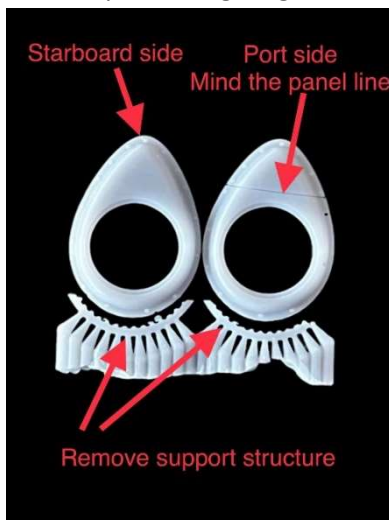

- Fighter Recon Parts: Prepare 2 8mm diameter (+/-1mm tolerance) round acetate sheets and affix them to the camera ports from inside.

Insert the camera blister on the fuselage holes. Fix the camera assembly to fuselage, better add plastic strips on the fuselage sides to support the rack.

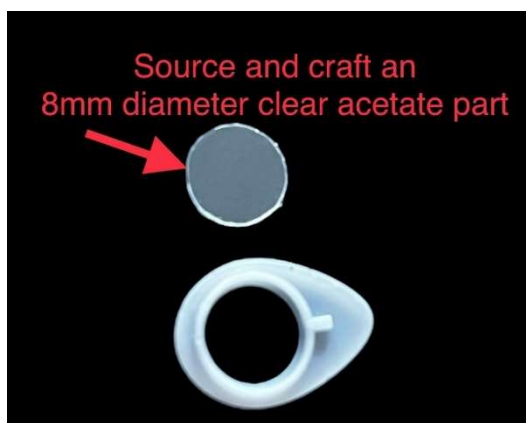

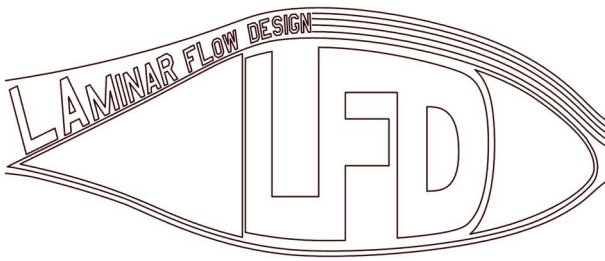

Spitfire F/FR Mk XIVc/e

1/32 Conversion Set for Tamiya Spitfire Mk VIII/IX "High Back"

Laminar Flow Design
 Email : info@laminarflowdesign.com
www.laminarflowdesign.com



Assemble the camera rack, you can choose the camera pointing side. Carefully align the camera objective with the windows and fix the rack into the fuselage, support the rack from under with plastic strip to ease and strengthen the assembly.

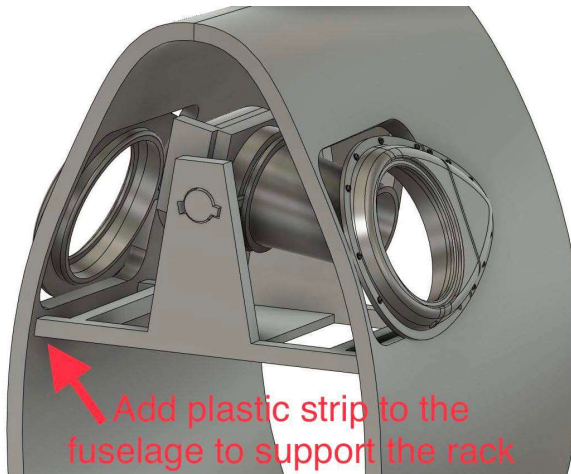

○ Downward ID light:

Prepare 3 4mm diameter round acetate sheets and sandwich them into each light assembly. Slide the lights into position in the wings and fuselage. Take care of the fuselage lamp orientation, check picture. For better accuracy, you can color the acetate sheet (amber center, red left, green right).

Fuselage light (amber)

Insert clear
4mm diameter
acetate sheet



Wing lights
(green & red)

Insert 4mm
diameter
acetate sheet



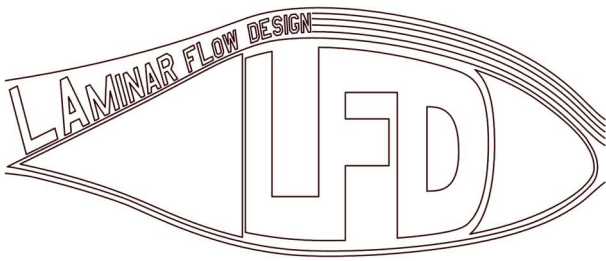

Spitfire F/FR Mk XIVc/e

1/32 Conversion Set for Tamiya Spitfire Mk VIII/IX "High Back"

Laminar Flow Design
 Email : info@laminarflowdesign.com
www.laminarflowdesign.com



- E-wing Panels & Blisters:
 Replace kit panels with the provided. Mind the locating knob on the outboard upper panels during clean-up of the support structures. Check your references for the correct canon blister type you need. Add the strengthening rib on the upper surface over the wheel bay

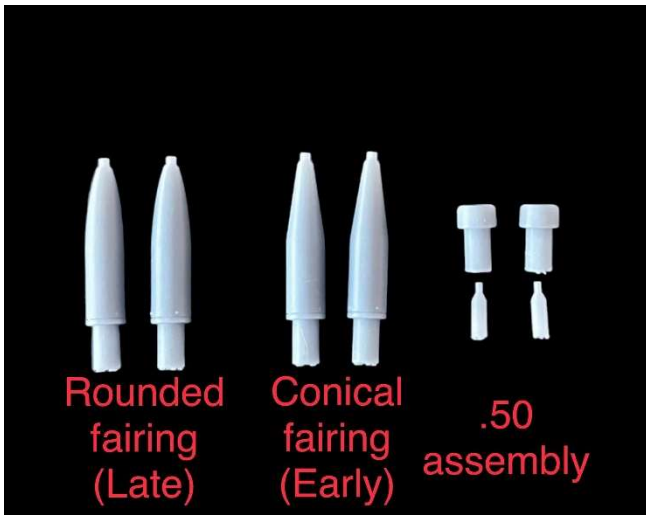
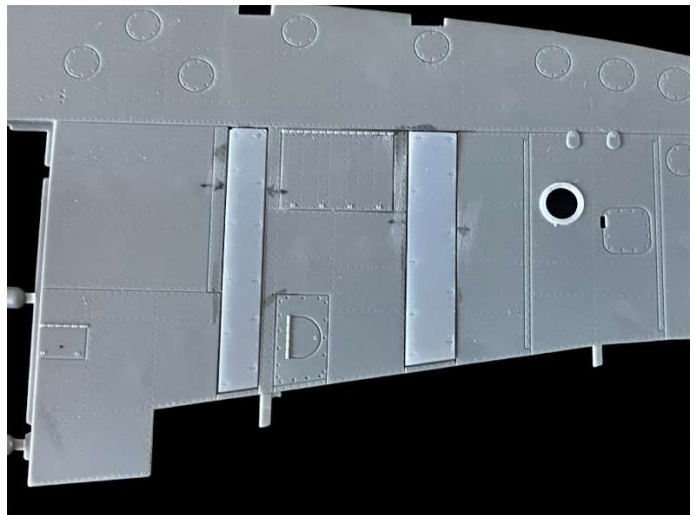
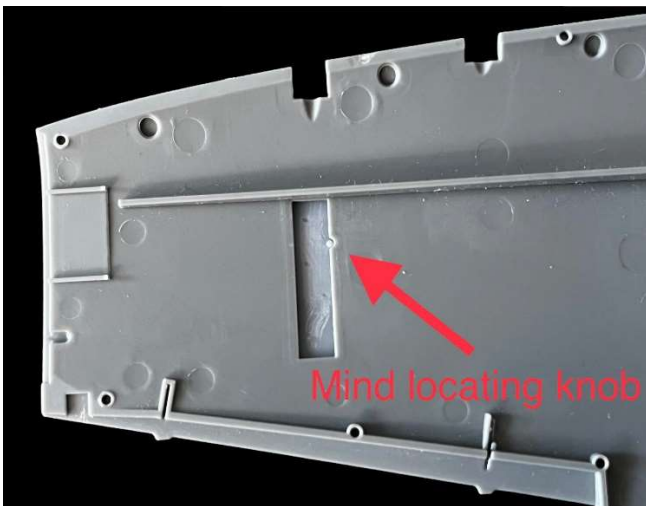
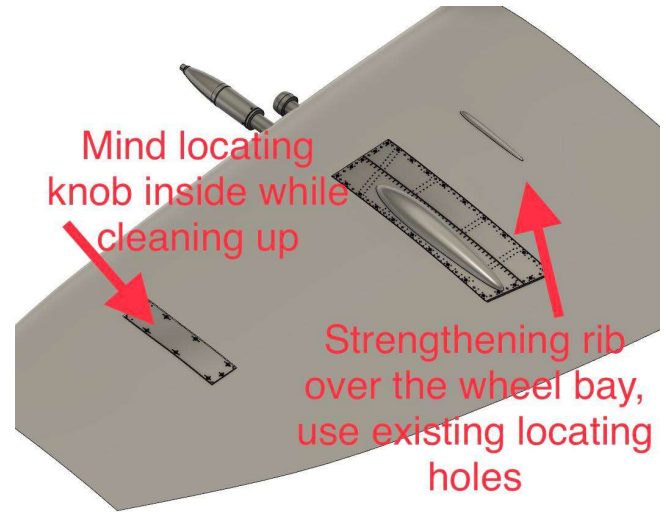

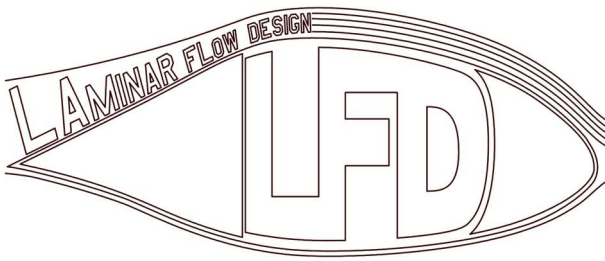

Spitfire F/FR Mk XIVc/e

1/32 Conversion Set for Tamiya Spitfire Mk VIII/IX "High Back"

Laminar Flow Design
 Email : info@laminarflowdesign.com
www.laminarflowdesign.com

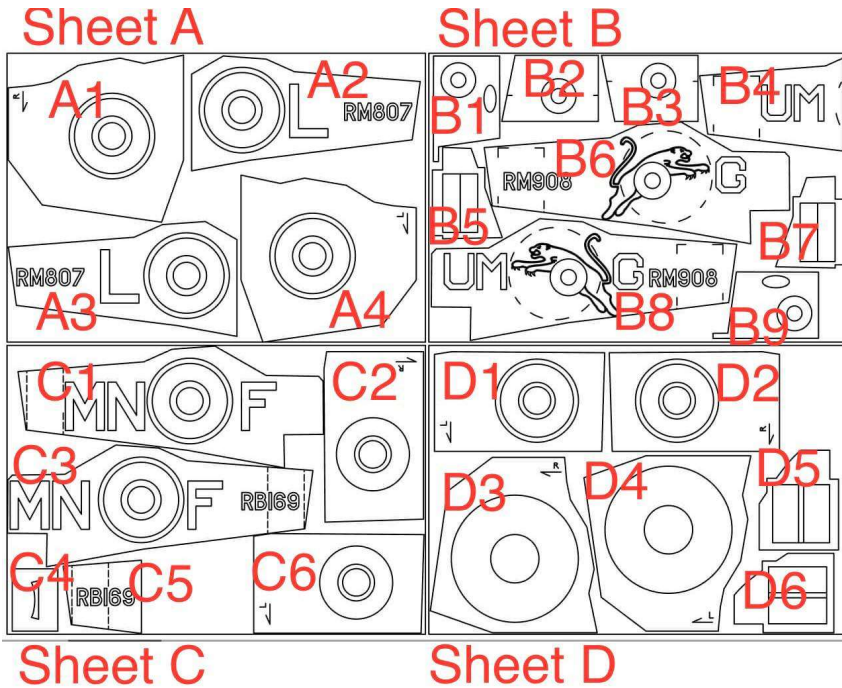

Painting and masks instructions:

- Arrow indicates the front direction, R/L the side of the plane.
- In order to avoid deformation during the mask application, apply a transfer tape over the masks during manipulation.
- Mask borders are to be aligned with panel line to help the positioning. Check on the drawing for the relevant panel lines.

Scheme 1: Spitfire F XIVc RB169, MN-F 350th Squadron (Belgian). 1944 Lympe

Use mask sheet C and D for this scheme.
 F Configuration, Mk14 Standard Rudder
 Rounded wing tips
 Fuselage Beam approach system (Part F58)
 C wing, Fishtail exhausts
 Standard Grey Green RAF Paint Scheme.
 Fairly clean painted under surfaces invasion stripes
 Grey Spinner
 Full Fuselage sky Rear band, and sky squadron codes.

Scheme 2: Spitfire FR XIVe RM807, L 430th Squadron (RCAF), 1945.

Use mask sheet A and D for this scheme.
 FR Configuration, Mk14 Standard Rudder
 Rounded wing tips
 Downward ID lights installed
 Fuselage Beam approach system (Part F58)
 E wing, Fishtail exhausts, conical 20mm fairings
 Standard Grey Green RAF Paint Scheme.
 IFF Antenna under right wing
 "L" Marking: White or light grey
 Black Spinner base behind the blades, light grey or Sky front spinner
 Fuselage Rear band freshly overpainted

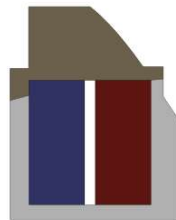

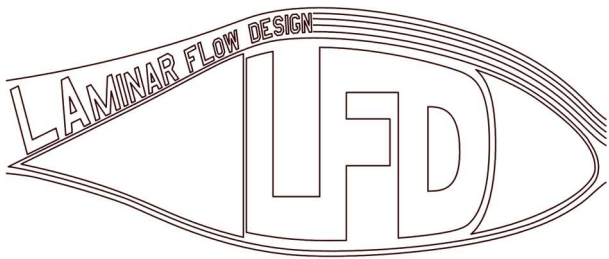

Spitfire F/FR Mk XIVc/e

1/32 Conversion Set for Tamiya Spitfire Mk VIII/IX "High Back"

Laminar Flow Design
Email : info@laminarflowdesign.com
www.laminarflowdesign.com

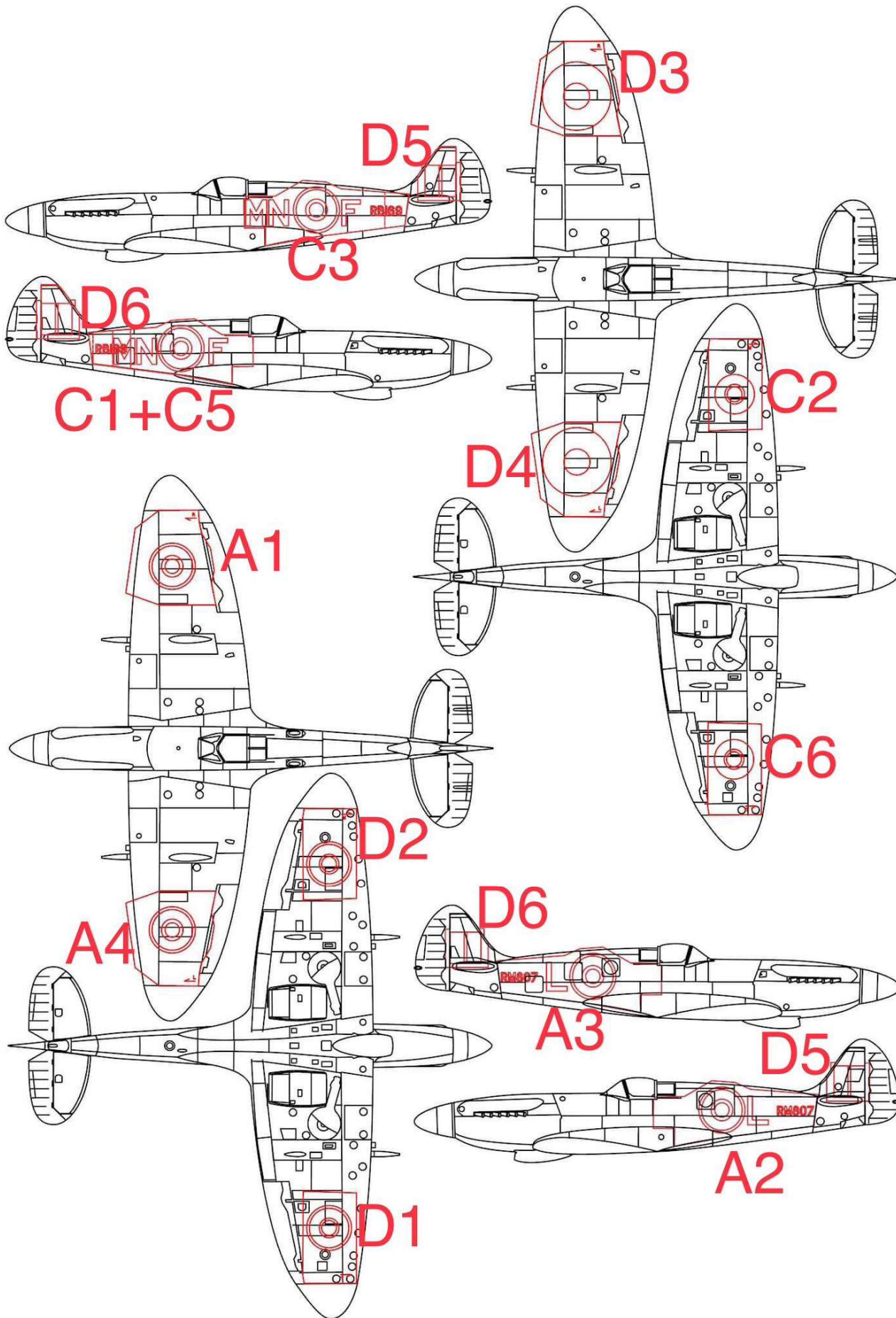

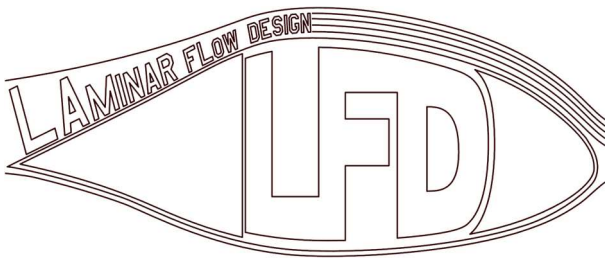

Spitfire F/FR Mk XIVc/e

1/32 Conversion Set for Tamiya Spitfire Mk VIII/IX "High Back"

Laminar Flow Design
 Email : info@laminarflowdesign.com
www.laminarflowdesign.com



Scheme 3: Spitfire F XIVe RM908 "UM-G", 152th Squadron RAF. 1945 Burma.

Use mask sheet B for this scheme.

Standard F Configuration, Mk14 Standard Rudder.

Rounded wing tips

Fuselage Beam approach system (Part F58)

E Wing, Round exhausts, rounded 20mm fairings

Standard Grey Green RAF Paint Scheme.

Grey spinner, White or Grey sqn codes

Black Panther with white outline.

Over painted European style cocardes, replaced by Far east 2 colors smaller cocardes

Serial RM908 (Black) Partial rear fuselage band (Grey), some early pictures of the machine shows a full band

Far east white recognition bands on upper & lower wings (width 21mm), and on upper & lower tailplane (width 15mm)

