

1/35 MILITARY MINIATURE VEHICLE UPGRADE SERIES PE35947









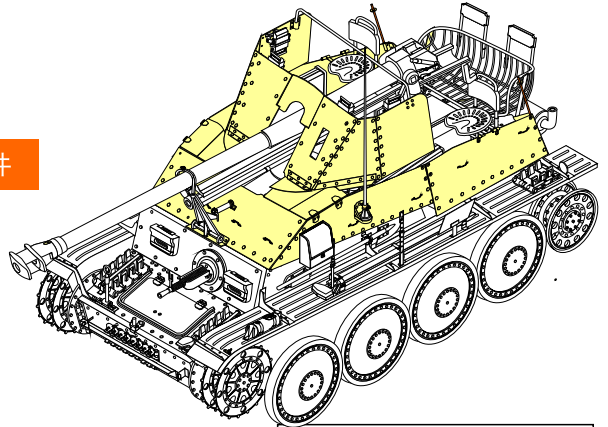
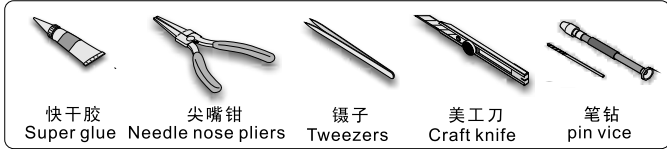

WWII German Tank Destroyer Marder III (Sd.Kfz.139) Armour Plates

二战德军黄鼠狼III坦克歼击车(Sd. Kfz. 139)装甲板改造件

[For TAMIYA 35248]

推荐使用工具 RECOMMENDED TOOLS



- 
安装
install
- 
折叠
bend
- A1**
改造件零件编号
PE/resin part number
- B12**
原零件编号
kit part number
- C22**
被替换的原零件编号
replaced kit part number
- 
 另一侧相同制作
repeat on opposite side
- 
切除
remove
- 
打磨
grind off
- 
弧度卷曲
radial bending
- 
制作若干组
multiple assembly
- 
选择安装
alternative
- 
钻孔
drill
- 
用胶棒制作
make from plastic rod

 用尖端在凹槽处冲压
 use penpoint to press on the dent

蚀刻片零件内朝面向上
 Put the part upside down
 用笔尖在凹槽处刺
 Use penpoint to press on the dent

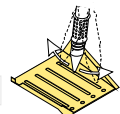
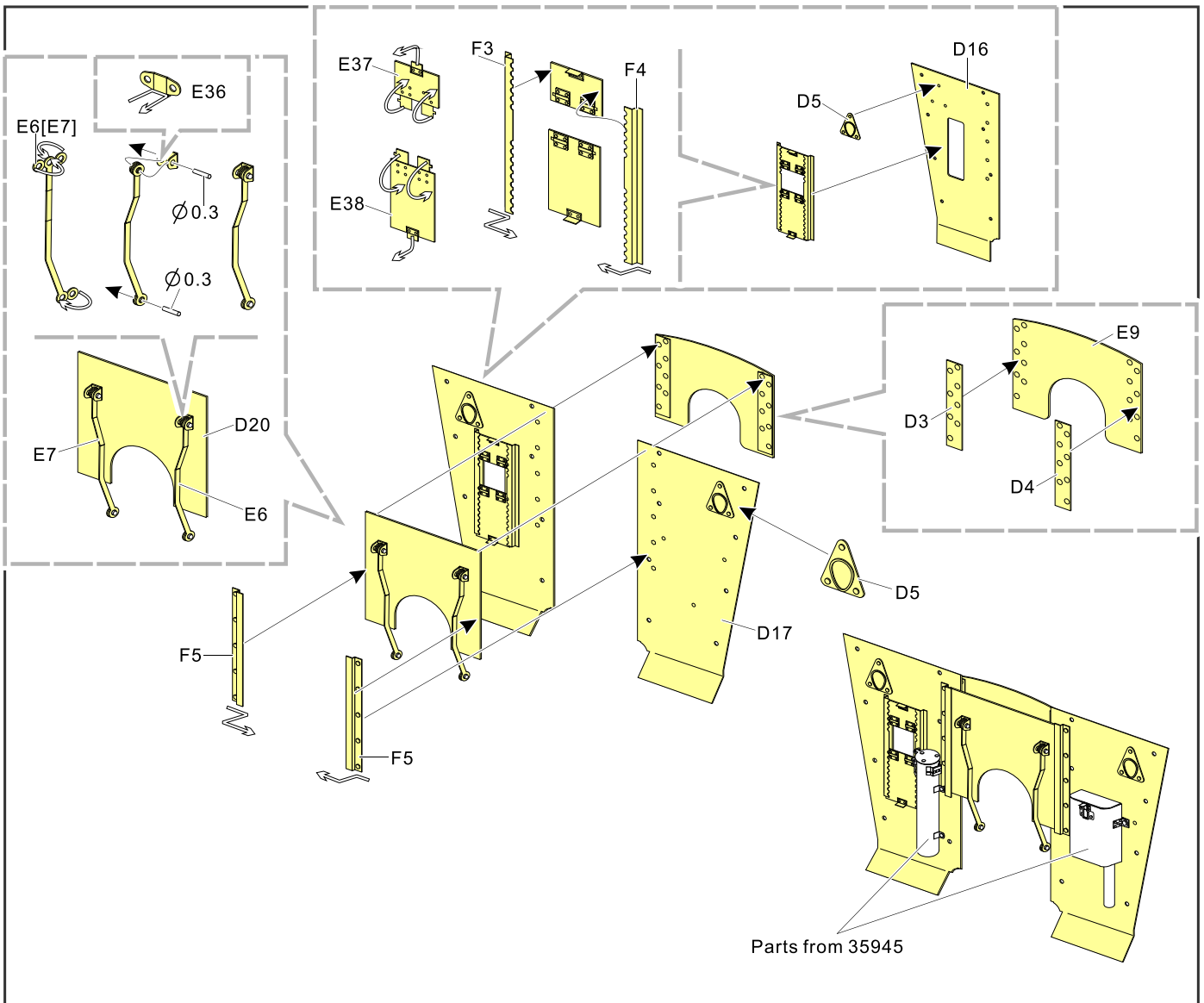
1/35 MILITARY MINIATURE VEHICLE UPGRADE SERIES PE35947

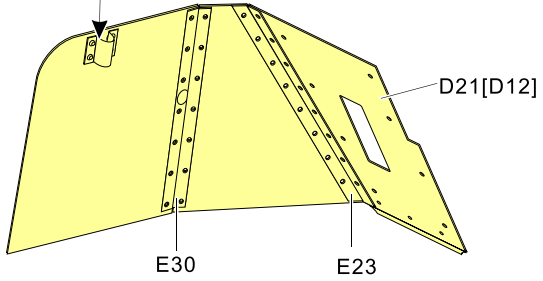
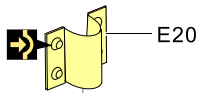

**VOYAGER
MODEL**



更多PE35947样品照片参考请扫一扫
MORE PICTUER OF PE 35947
REFERENCE SCAN HERE

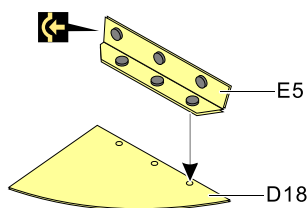
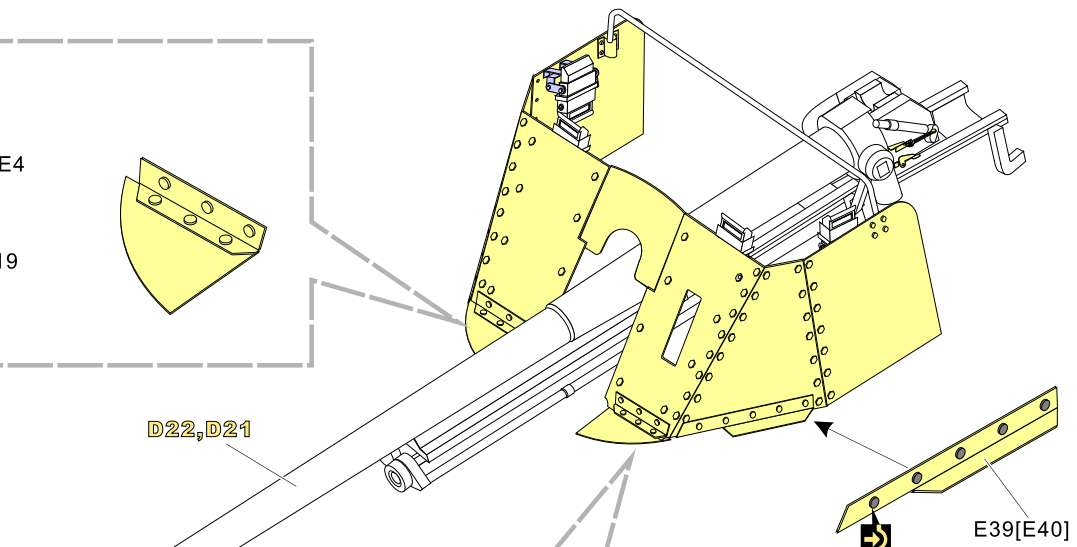
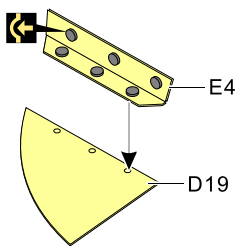
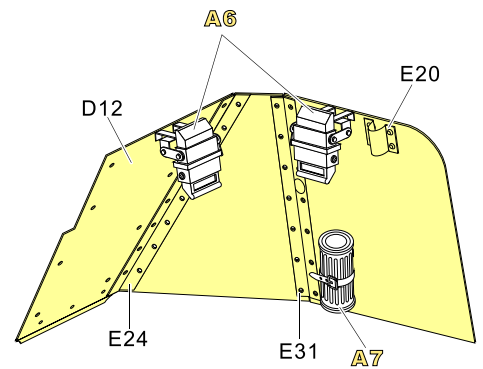
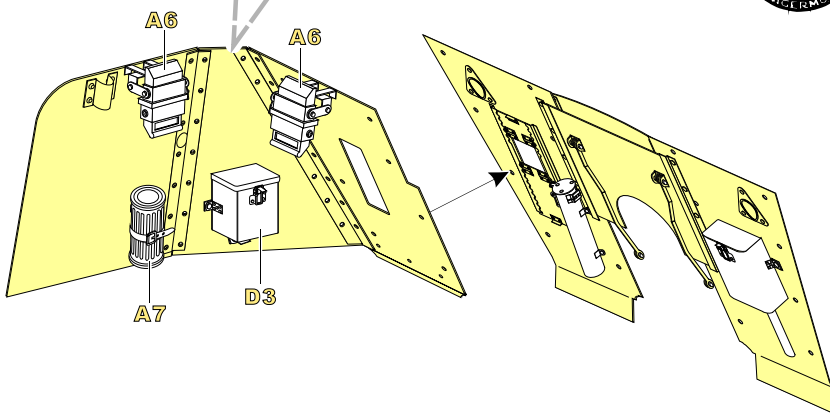

1/35 MILITARY MINIATURE VEHICLE UPGRADE SERIES PE35947

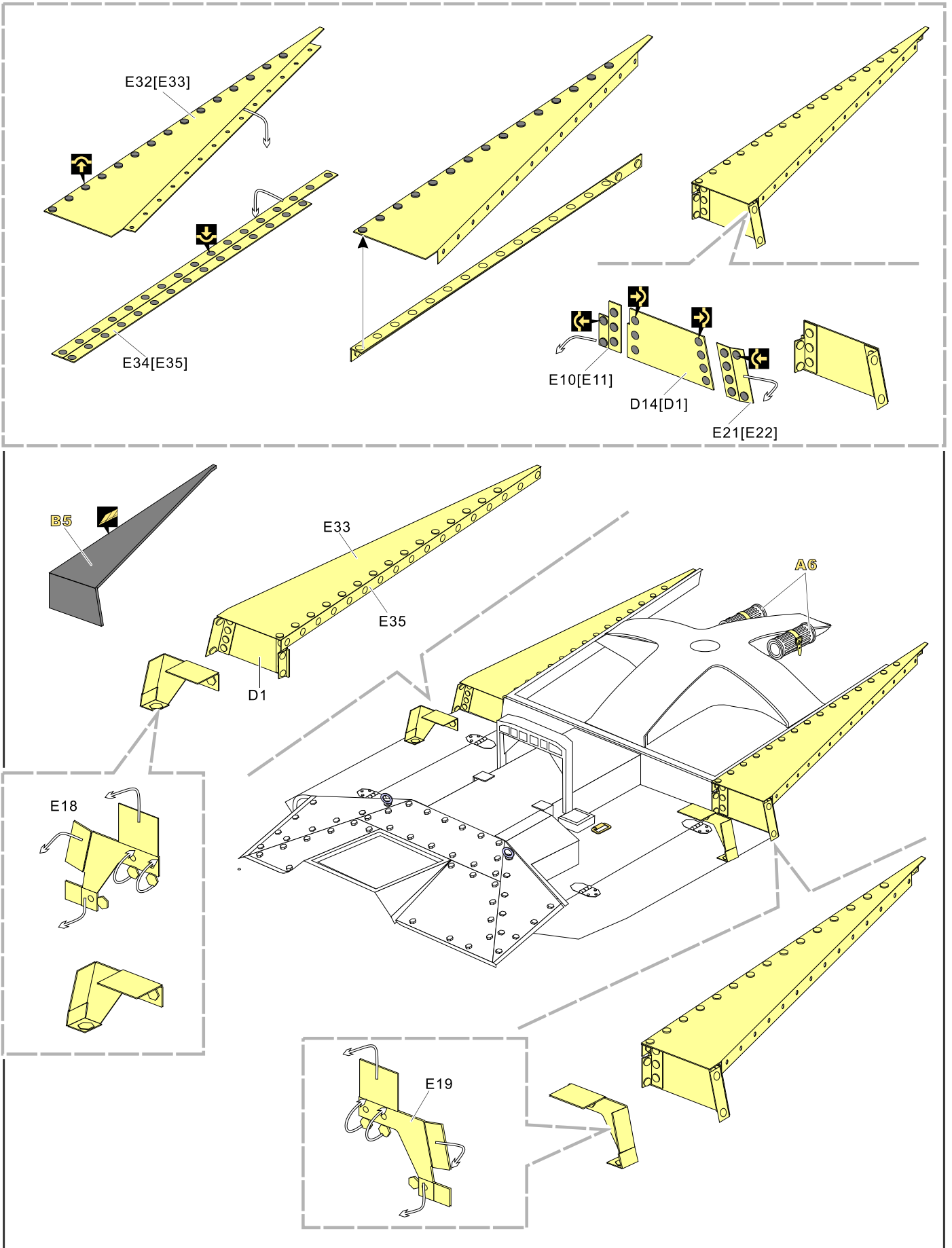

1/35 MILITARY MINIATURE VEHICLE UPGRADE SERIES PE35947

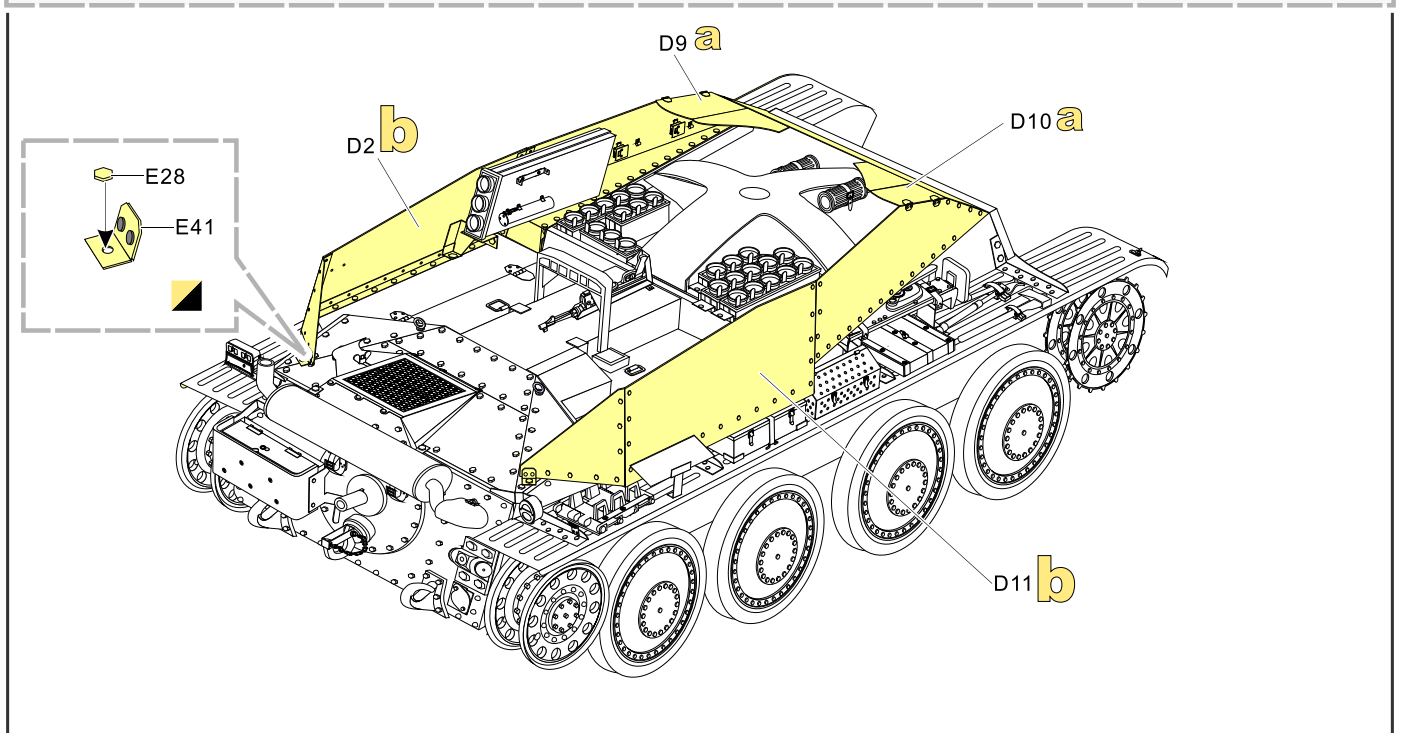
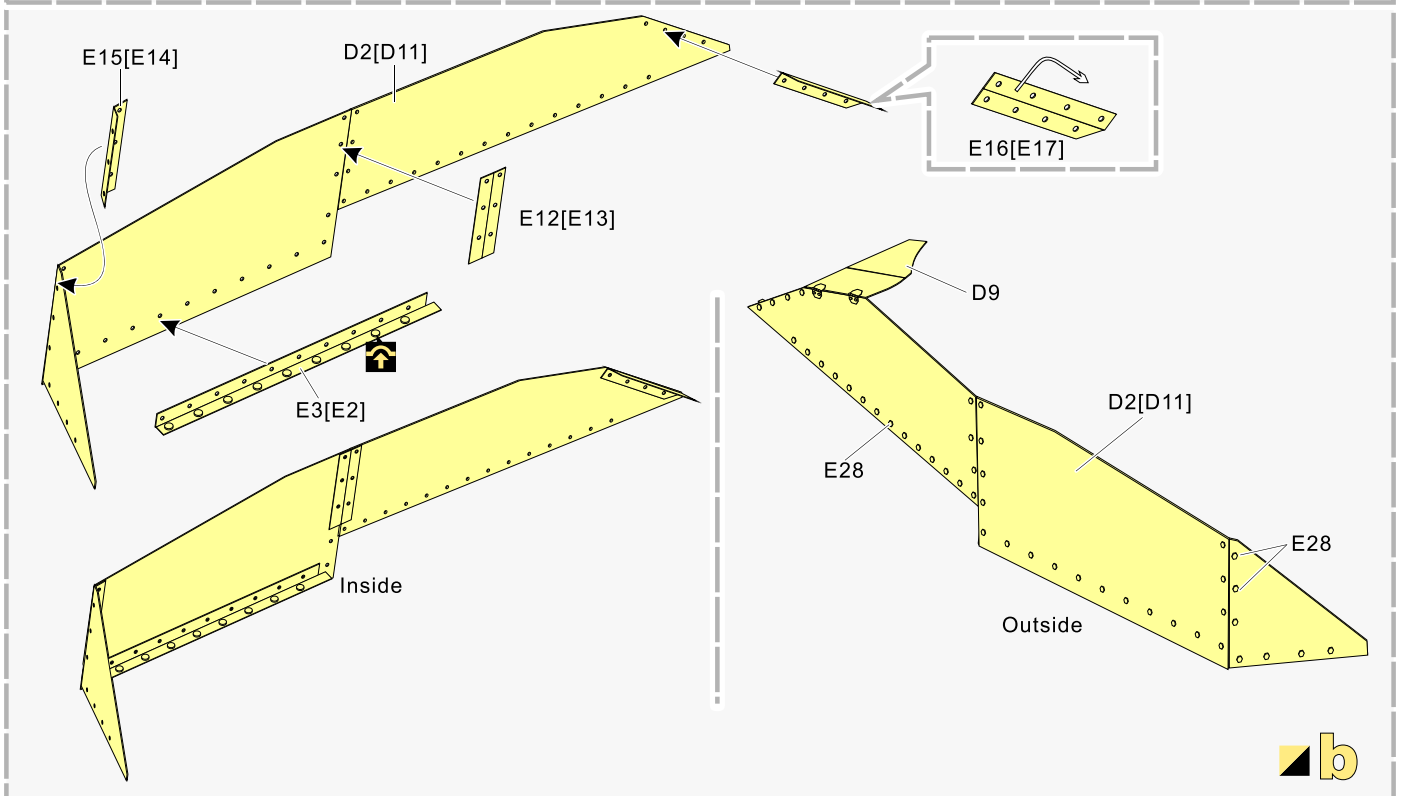
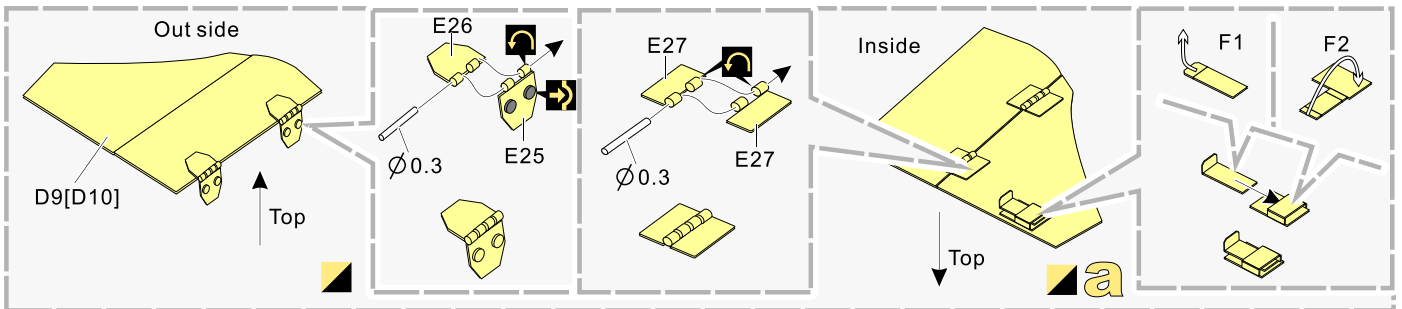

1/35 MILITARY MINIATURE VEHICLE UPGRADE SERIES PE35947

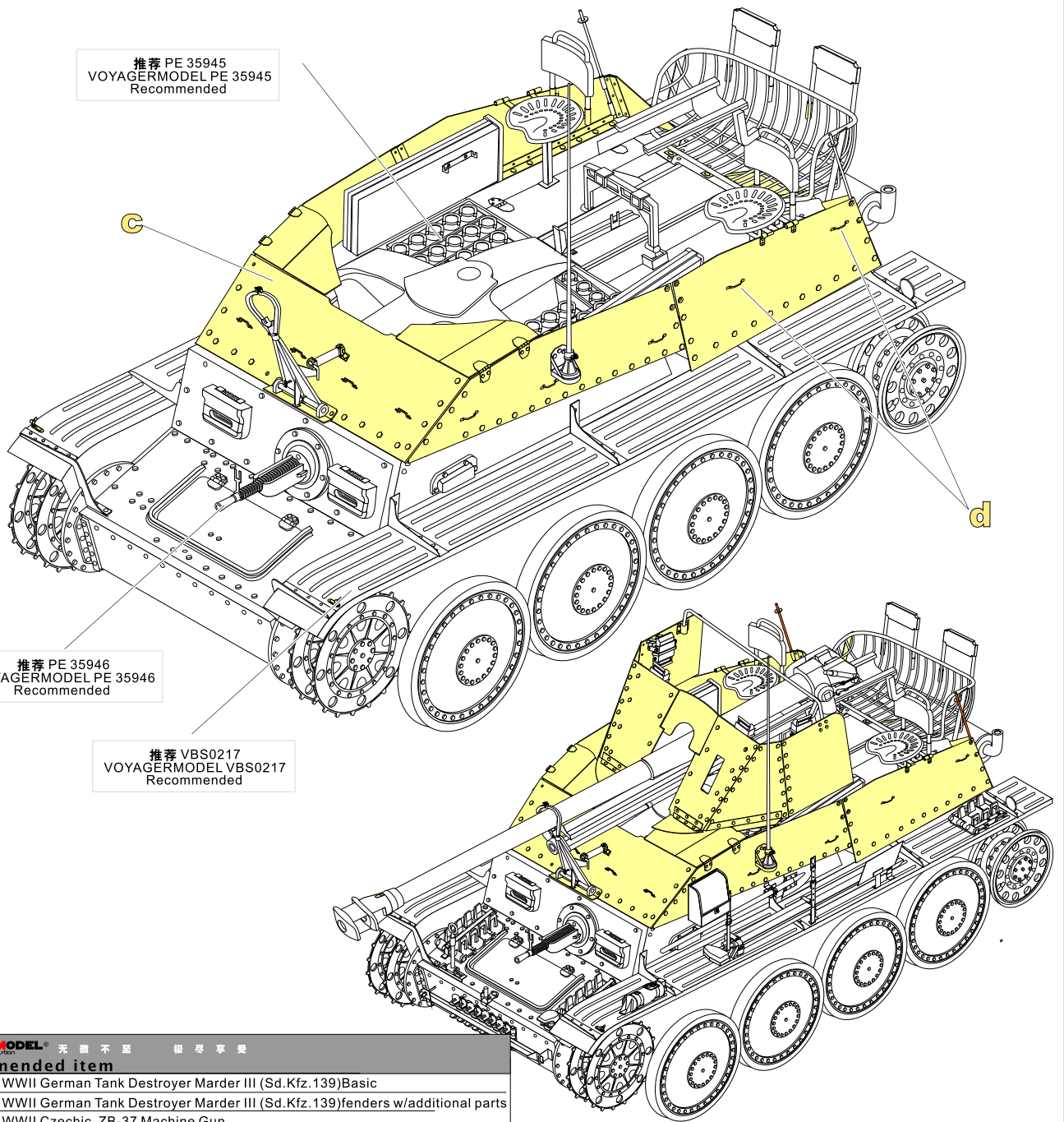
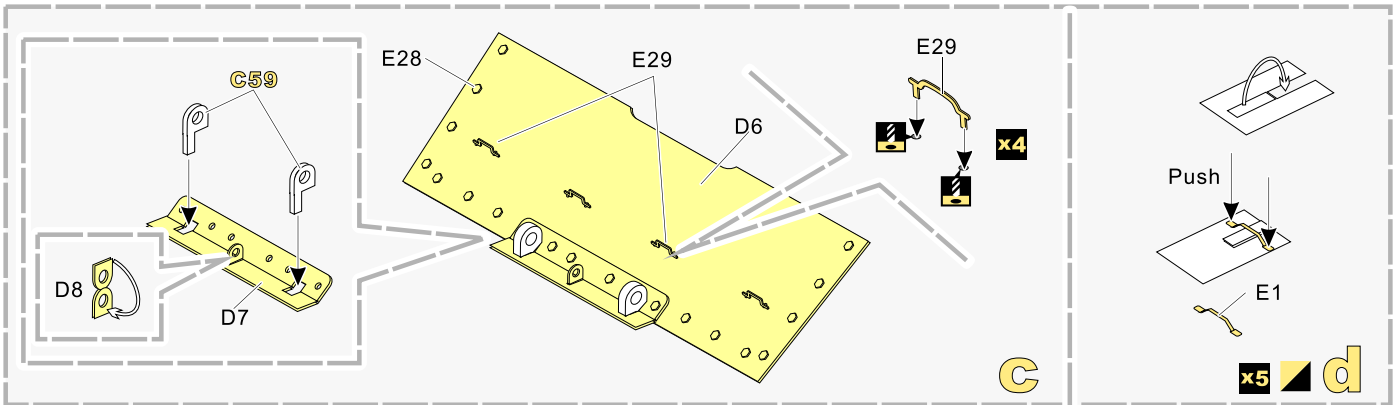

VOYAGERMODEL® 无微不至 极尽享受

Recommended item

- PE 35945 WWII German Tank Destroyer Marder III (Sd.Kfz.139)Basic
- PE 35946 WWII German Tank Destroyer Marder III (Sd.Kfz.139)fenders w/additional parts
- VBS 0217 WWII Czechic ZB-37 Machine Gun