

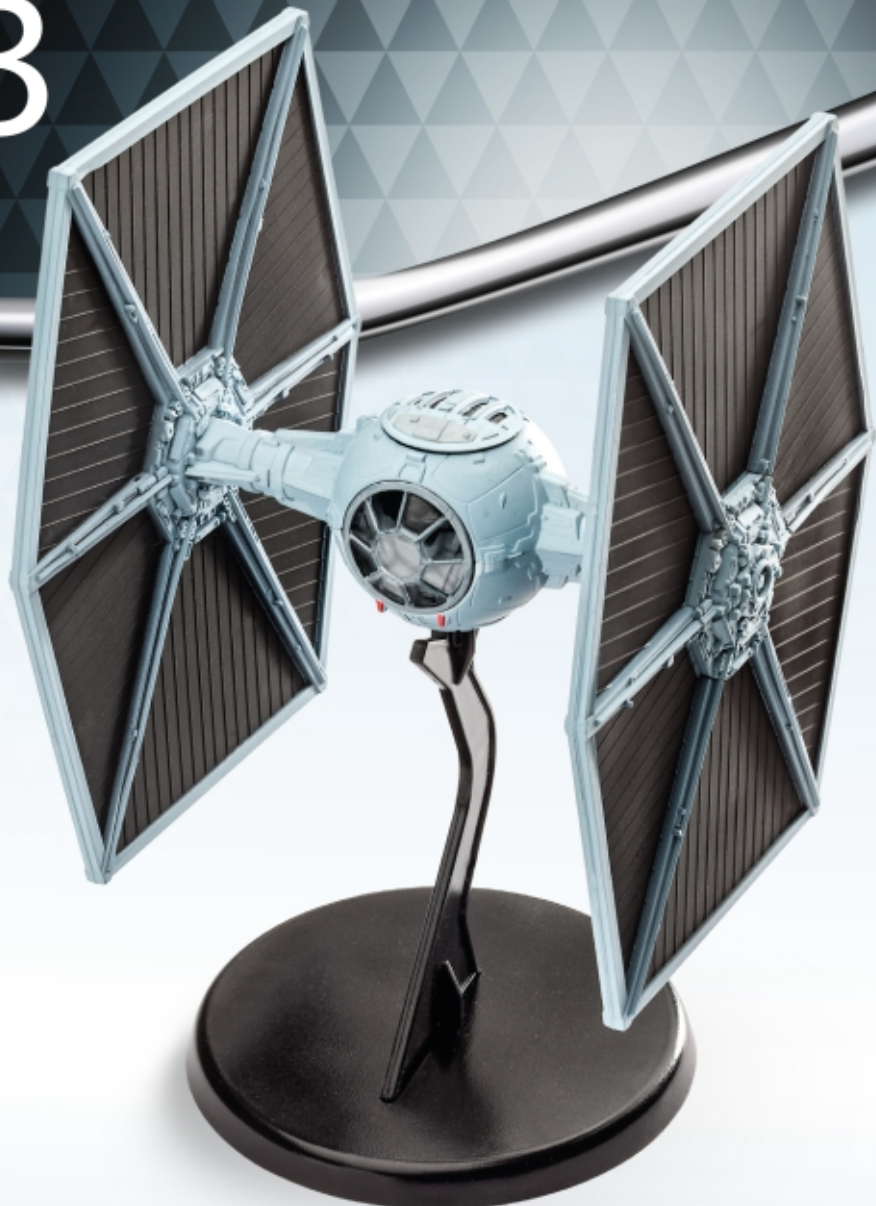

03605 - 0379

LEVEL 3
1 2 3 4 5



TIE Fighter™

Beiliegenden Sicherheitstext beachten / Please note the enclosed safety advice

- Ⓢ Beiliegenden Sicherheitstext beachten und nachschlagbereit halten.
- Ⓢ Please note the enclosed safety advice and keep safe for later reference.
- Ⓢ Respecter les consignes de sécurité ci-jointes et les conserver à portée de main.
- Ⓢ Houdt u aan de bijgaande veiligheidsinstructies en hou deze steeds bij de hand.
- Ⓢ Seguire le avvertenze di sicurezza allegate e tenerle a portata di mano.
- Ⓢ Observar y siempre tener a disposición este texto de seguridad adjunto.
- Ⓢ Ter em atenção o texto de segurança anexo e guardá-lo para consulta.
- Ⓢ Overhold vedlagte sikkerhedsanvisninger og hav dem liggende i nærheden.
- Ⓢ Ha alltid vedlagt sikkerhetstekst klar til bruk.
- Ⓢ Beakta bifogad säkerhetstext och håll den i beredskap.
- Ⓢ Huomioi ja säilytä oheiset varoitukset.
- Ⓢ Соблюдать технику безопасности, сохранить инструкцию для дальнейших обращений.
- Ⓢ Przestrzegać załączonego tekstu dotyczącego bezpieczeństwa i mieć go zawsze pod ręką.
- Ⓢ Dodržujte tento příložený bezpečnostní text a mějte ho po ruce.
- Ⓢ A mellékelt biztonsági szöveget vegye figyelembe és tartsa fellepozásra készen.
- Ⓢ Respektujte příložený bezpečnostní text a uchovajte ho pre budúce použitie.
- Ⓢ Respectați textul de siguranță atașat și păstrați-l la îndemână.
- Ⓢ Спазуйте приложенія текст за безопасност и го дръжте под ръка за справки.
- Ⓢ Priložena varnostna navodila izvajajte in jih hranite na vsem dostopnem mestu.
- Ⓢ Λάβετε υπόψη σας το συννημένο κείμενο ασφαλείας και φυλάξτε το ώστε να ανατρέχετε σε αυτό όποτε χρειάζεται.
- Ⓢ Ekteki güvenlik talimatlarını dikkate alıp, bakabileceğiniz bir şekilde muafaza ediniz.

© 2015 Revell GmbH, Henschelstr. 20-30, D-32257 Bünde. A subsidiary of Hobbico, Inc. © & ™ Lucasfilm Ltd.

REVELL IS THE REGISTERED TRADEMARK OF REVELL GMBH, GERMANY. www.revell.de

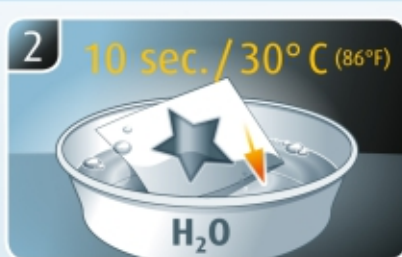
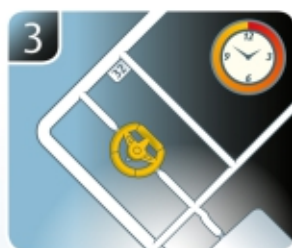
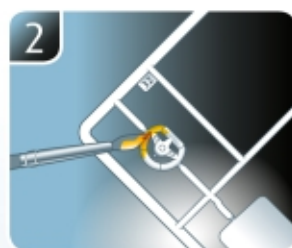
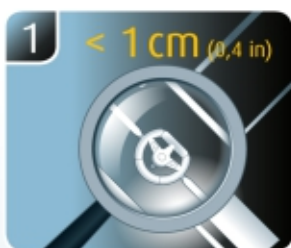
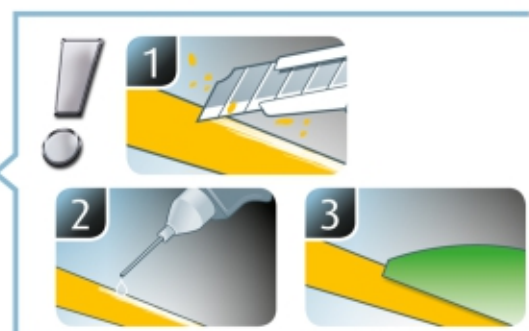
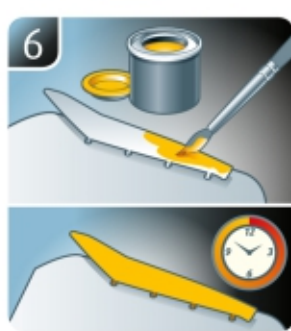
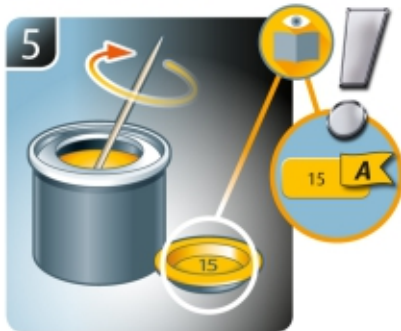
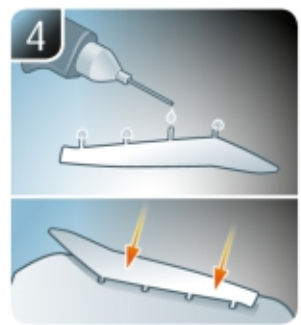
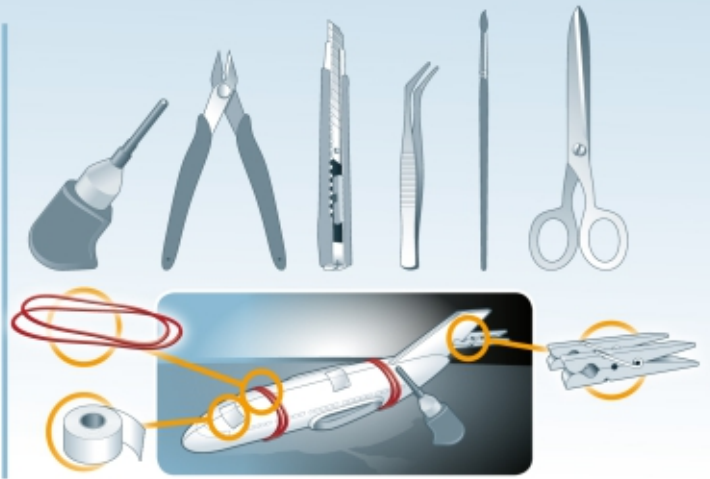

- ☞ Weitere Tipps und Tricks.
- ☞ Additional tips and tricks.
- ☞ Conseils et astuces supplémentaires.
- ☞ Andere tips en trucs.
- ☞ Ulteriori consigli e suggerimenti.
- ☞ Consejos y sugerencias adicionales.
- ☞ Mais dicas e truques.

- ☞ Flere tips og tricks.
- ☞ Flere tips og tricks.
- ☞ Ytterligere tips och tricks.
- ☞ Lisää vinkkejä ja niksejä.
- ☞ Другие советы и хитрости.
- ☞ Dalsze wskazówki i sugestie.
- ☞ Další tipy a rady.
- ☞ További ötletek és fogások.
- ☞ Dalsie tipy a triky.
- ☞ Alte sfaturi și trucuri.

- ☞ Други полезни съвети и трикове.
- ☞ Nadaljnji nasveti in zvijače.
- ☞ Πρόσθετες συμβουλές και κόλπα.
- ☞ Diğer öneriler ve ipuçları.

www.revell.de



- ☒ Kleben
- ☒ Glue
- ☒ Coller
- ☒ Lijmen
- ☒ Incollare
- ☒ Pegamento
- ☒ Colar
- ☒ Lim
- ☒ Lime
- ☒ Limma
- ☒ Liimaa
- ☒ Клеить
- ☒ Przykleić
- ☒ Slepiti
- ☒ Ragassza rá
- ☒ Lepit
- ☒ Lipiti
- ☒ Залепете
- ☒ Prilepite
- ☒ Κολλήστε
- ☒ Yapıştırma



- ☒ Nicht kleben
- ☒ Don't glue
- ☒ Ne pas coller
- ☒ Niet lijmen
- ☒ Non incollare
- ☒ No pegamento
- ☒ Não colar
- ☒ Lim ikke
- ☒ Ikke lime
- ☒ Limma inte
- ☒ Älä liimaa
- ☒ Не клеить
- ☒ Nie przyklejać
- ☒ Nelepiti
- ☒ Ne ragassza rá
- ☒ Nelepiti
- ☒ Nu lipiti
- ☒ Не лепете
- ☒ Ne lepite
- ☒ Μην κολλήσετε
- ☒ Yapıştırmayın



- ☒ Bemalen
- ☒ Paint
- ☒ Peindre
- ☒ Beschilderen
- ☒ Colorare
- ☒ Pintar
- ☒ Pintar
- ☒ Mal
- ☒ Male
- ☒ Måla
- ☒ Maalaa
- ☒ Раскрасить
- ☒ Pomalować
- ☒ Pomalovat
- ☒ Fesse be
- ☒ Natriet
- ☒ Vopsiti
- ☒ Боядисайте
- ☒ Pobarvajte
- ☒ Βάψτε
- ☒ Boyama



- ☒ Zusammenbau Reihenfolge.
- ☒ Sequence of assembly.
- ☒ Ordre d'assemblage.
- ☒ Volgorde van montage.
- ☒ Sequenza di assemblaggio.
- ☒ Secuencia de montaje.
- ☒ Sequência de montagem.
- ☒ Samlerækkefølge.
- ☒ Monteringsrekkefølge.
- ☒ Montering ordningsföljd.
- ☒ Kokoamisjärjestys.
- ☒ Последовательность сборки.
- ☒ Kolejność montażu.
- ☒ Pořadí složení.
- ☒ Összerakási sorrend.
- ☒ Poradie zostavenia.
- ☒ Ordinea asamblării.
- ☒ Последовательность на съглобяване.
- ☒ Vrstni red sestavljanja.
- ☒ Σειρά τοποθέτησης.
- ☒ Parçaları birleştirme sırası.



- ☒ Klarsichtteile
- ☒ Clear parts
- ☒ Pièces transparentes
- ☒ Transparente onderdelen
- ☒ Parti trasparenti
- ☒ Piezas transparentes
- ☒ Peças transparentes
- ☒ Klare dele
- ☒ Klare deler
- ☒ Genomskinliga detaljer
- ☒ Läpinäkyvät osat
- ☒ Прозрачные детали
- ☒ Przezrocyste części
- ☒ Průhledné díly
- ☒ Átlátszó alkatrészek
- ☒ Číre diely
- ☒ Piese transparente
- ☒ Прозрачни части
- ☒ Prozorni deli
- ☒ Διάφανα μέρη
- ☒ Şeffaf parçalar



- ☒ Abziehbild in Wasser einweichen und anbringen.
- ☒ Soak and apply decals.
- ☒ Mouiller et appliquer les décalcomanies.
- ☒ Transfer in water even laten weken en aanbrengen.
- ☒ Immergere la decalcomania nell'acqua e applicarla.
- ☒ Mojar y aplicar calcomanías.
- ☒ Amolecer o decalque em água e aplicar.
- ☒ Gör överföringsbilledet vådt og sæt det på.
- ☒ Myk opp avtrekkingsbildet i vann og sett på.
- ☒ Blötlägg dekalen i vatten och sätt på den.
- ☒ Pehmitä siirtokuva vedessä ja siirrä paikalleen.
- ☒ Опустите переводную картинку в воду и нанесите её.
- ☒ Namoczyć kalkomanie w wodzie i przykleić.
- ☒ Nechte obtisk odmočit ve vodě a přilepte.
- ☒ Merítse vízbe és helyezze fel a matricát.
- ☒ Obtlačkový obrázok namočte do vody a priložte na plochu.
- ☒ Inmuiați abțibildul în apă și aplicați-l.
- ☒ Потопете ваденката във вода и я поставете.
- ☒ Prelepnicu namakajte v vodi. In namestite
- ☒ Μουσκεψτε σε νερό και τοποθετήστε τις χαλκομανίες.
- ☒ Çikartmayı suda yumuşatın ve takın.



- ☒ Zur Anbringung der Klarteile empfohlen.
- ☒ Recommended to fix clear parts.
- ☒ Recommandé pour fixer les pièces transparentes.
- ☒ Aanbevolen voor het aanbrengen van transparante delen.
- ☒ Raccomandato per l'applicazione delle decalcomanie.
- ☒ Recomendado para fijar las piezas transparentes.
- ☒ Recomendado para a fixação das peças transparentes.
- ☒ Anbefales til anbringelse af de klare dele.
- ☒ Anbefales til å feste klare deler.
- ☒ Rekommenderad för montering av de genomskinliga detaljerna.
- ☒ Suositellaan läpinäkyvien osien siirtämiseen.
- ☒ Рекомендується для кріплення прозорчастих деталей.
- ☒ Zalecane do przyklejenia przezroczystych części.
- ☒ Doporučujeme k umístění průhledných dílů.
- ☒ Az átlátszó darabok felhelyezéséhez ajánlható.
- ☒ Odporuča sa pre umiestnenie čírych dielov.
- ☒ Recomandat pentru aplicarea pieselor transparente.
- ☒ Препоръчва се за поставяне на прозрачни части.
- ☒ Pri nameščenju prozornih delov priporočamo.
- ☒ Συνιστάται για την τοποθέτηση των διαφανών μερών.
- ☒ Şeffaf parçaların takılması için önerilir.



- ☒ Zur Anbringung der Abziehbilder empfohlen.
- ☒ Recommended for affixing the decals.
- ☒ Recommandé pour l'application des décalcomanies.
- ☒ Aanbevolen voor het aanbrengen van de transfers.
- ☒ Raccomandato per l'applicazione delle decalcomanie.
- ☒ Recomendado para fijar bien las calcomanías.
- ☒ Recomendado para a fixação dos autocolantes.
- ☒ Anbefales til anbringelse af overføringsbillederne.
- ☒ Anbefales til å feste avtrekksbilder.
- ☒ Rekommenderad för montering av klisterdekalerna.
- ☒ Suositellaan siirtokuvien siirtämiseen.
- ☒ Рекомендується для нанесення переводних картинок.
- ☒ Zalecane do przyklejenia kalkomanii.
- ☒ Doporučujeme k umístění obtiskovacích obrázků.
- ☒ A matrica felhelyezéséhez ajánlható.
- ☒ Odporuča sa pre umiestnenie obtlačkového obrázku.
- ☒ Recomandat pentru aplicarea abțibildurilor.
- ☒ Препоръчва се за поставяне на ваденки.
- ☒ Pri nameščenju nalepnic priporočamo.
- ☒ Συνιστάται για την τοποθέτηση των χαλκομανιών.
- ☒ Çikartmaların takılması için önerilir.

- * ☒ Nicht enthalten
- ☒ Not included
- ☒ Non fourni
- ☒ Behoort niet tot de levering
- ☒ Non incluso

- ☒ No incluido
- ☒ Não incluído
- ☒ Medfølger ikke
- ☒ Ikke inkludert
- ☒ Ingår ej
- ☒ Ei sisällä

- ☒ He содержится
- ☒ Nie wchodzi w zakres dostawy
- ☒ Není obsaženo
- ☒ Nem tartalmazza
- ☒ Neobsahuje

- ☒ Nu este inclus
- ☒ He se uključava u komplekta
- ☒ Ni priloženo
- ☒ Δεν περιλαμβάνεται
- ☒ İçermiyor

Benötigte Farben / Required colours

- Ⓢ Peintures nécessaires
- Ⓢ Benodigde kleuren
- Ⓢ Colori necessari
- Ⓢ Colores necesarios
- Ⓢ Cores necessàrias
- Ⓢ Nødvendige farver
- Ⓢ Nødvendige farger
- Ⓢ Erforderliga färger
- Ⓢ Tarvittavat värit
- Ⓢ Необходимые краски
- Ⓢ Potrzebne kolory
- Ⓢ Potřebné barvy
- Ⓢ Szükséges színek
- Ⓢ Požadované farby
- Ⓢ Colori necesare
- Ⓢ Необходими цветове
- Ⓢ Potrebne barve
- Ⓢ Απαιτούμενα χρώματα
- Ⓢ Gerekti renkler

332

D

- Ⓢ Leuchtrot seidenmatt
- Ⓢ Luminous red silk matt
- Ⓢ Rouge voyant satiné mat
- Ⓢ Neonrood zijdemat
- Ⓢ Rosso luminoso opaco satinato
- Ⓢ Rojo luminoso mate satinado
- Ⓢ Vermelho fluorescente mate sedoso
- Ⓢ Lysende rød silkematt
- Ⓢ Selvlýsende rød silkematt
- Ⓢ Lysande rød sidenmatt
- Ⓢ Hohtava punainen silkkimatta
- Ⓢ Ярко-красный шелковисто-матовый
- Ⓢ Świetlisty czerwony jedwabście matowy
- Ⓢ Červená svítící jemně matný
- Ⓢ Világító piros, fakőselymes
- Ⓢ Svetielkujúca červená hodvábne matný
- Ⓢ Roşu luminos satinat
- Ⓢ Светещо червено коприненоматово
- Ⓢ Svetlo-rdeča svilenomat
- Ⓢ Κόκκινο φωτεινό σατινέ
- Ⓢ Palak kırmızı ipeksi mat

06

A

- Ⓢ Teerschwartz matt
- Ⓢ Tar black matt
- Ⓢ Noir goudron mat
- Ⓢ Teerzwart mat
- Ⓢ Nero catrame opaco
- Ⓢ Negro brea mate
- Ⓢ Preto alcatrão mate
- Ⓢ Tjæresort mat
- Ⓢ Tjæresort matt
- Ⓢ Tjærsvart matt
- Ⓢ Tervanmusta matta
- Ⓢ Битумно-чёрный матовый
- Ⓢ Czarna smola matowy
- Ⓢ Dehtová černá matný
- Ⓢ Kátrányfekete, fénytelen
- Ⓢ Čierna térová matný
- Ⓢ Negro-închis mat
- Ⓢ Катранено черно матово
- Ⓢ Katransko-črna mat
- Ⓢ Μαύρο βαθύ ματ
- Ⓢ Katran siyahı mat

07

B

- Ⓢ Schwarz glänzend
- Ⓢ Black gloss
- Ⓢ Noir brillant
- Ⓢ Zwart glanzend
- Ⓢ Nero lucido
- Ⓢ Negro brillante
- Ⓢ Preto brilhante
- Ⓢ Sort blank
- Ⓢ Sort glansende
- Ⓢ Svart blank
- Ⓢ Musta kiiltävä
- Ⓢ Чёрный глянцевый
- Ⓢ Czarny błyszczący
- Ⓢ Černá lesklý
- Ⓢ Fekete, fényes
- Ⓢ Čierna lesklý
- Ⓢ Negro-strălucitor
- Ⓢ Черно глянцово
- Ⓢ Črna sijóča
- Ⓢ Μαύρο γυαλιστερό
- Ⓢ Siyah parlak

76

C

- Ⓢ Hellgrau matt
- Ⓢ Light grey matt
- Ⓢ Gris clair mat
- Ⓢ Lichtgrijs mat
- Ⓢ Grigio chiaro opaco
- Ⓢ Gris claro mate
- Ⓢ Cinza claro mate
- Ⓢ Lysegrå mat
- Ⓢ Lysegrå matt
- Ⓢ Ljusgrå matt
- Ⓢ Vaaleanharmaa matta
- Ⓢ Светло-серый матовый
- Ⓢ Jasnoszary matowy
- Ⓢ Světlá šedivá matný
- Ⓢ Világosszürke, fénytelen
- Ⓢ Svetlo sivá matný
- Ⓢ Gri-deschis mat
- Ⓢ Светлосиво матово
- Ⓢ Svetlo-siva mat
- Ⓢ Γκρι ανοιχτό ματ
- Ⓢ Açık gri mat

91

E

- Ⓢ Eisen metallic
- Ⓢ Iron metallic
- Ⓢ Fer métallique
- Ⓢ Ijzer metallic
- Ⓢ Ferro metallico
- Ⓢ Acero metálico
- Ⓢ Aço metálico
- Ⓢ Stål metallisk
- Ⓢ Jern metallic
- Ⓢ Stål metallic
- Ⓢ Teräs metallinen
- Ⓢ Сталь металлিক
- Ⓢ Grafit metaliczny
- Ⓢ Ocelová metalizový
- Ⓢ Acélmetál
- Ⓢ Ocelová metaliza
- Ⓢ Fier metallic
- Ⓢ Желязо металик
- Ⓢ Železna kovinska
- Ⓢ Χρώμα σιδήρου μεταλλικό
- Ⓢ Metalik metalik

79

F

- Ⓢ Blaugrau matt
- Ⓢ Blue-grey matt
- Ⓢ Gris bleu mat
- Ⓢ Blauwgrijs mat
- Ⓢ Grigio bluastro opaco
- Ⓢ Azul grisáceo mate
- Ⓢ Azul acinzentado mate
- Ⓢ Blågrøn mat
- Ⓢ Gråblå matt
- Ⓢ Blågrøn matt
- Ⓢ Harmaansininen matta
- Ⓢ Сери-синий матовый
- Ⓢ Niebieskoszary matowy
- Ⓢ Sedomodrá matný
- Ⓢ Kékesszürke, fénytelen
- Ⓢ Sivomodrá matný
- Ⓢ Albastru cenuşiu mat
- Ⓢ Синьо-сиво матово
- Ⓢ Modro-siva mat
- Ⓢ Γκρι-μπλε ματ
- Ⓢ Gri mavi mat

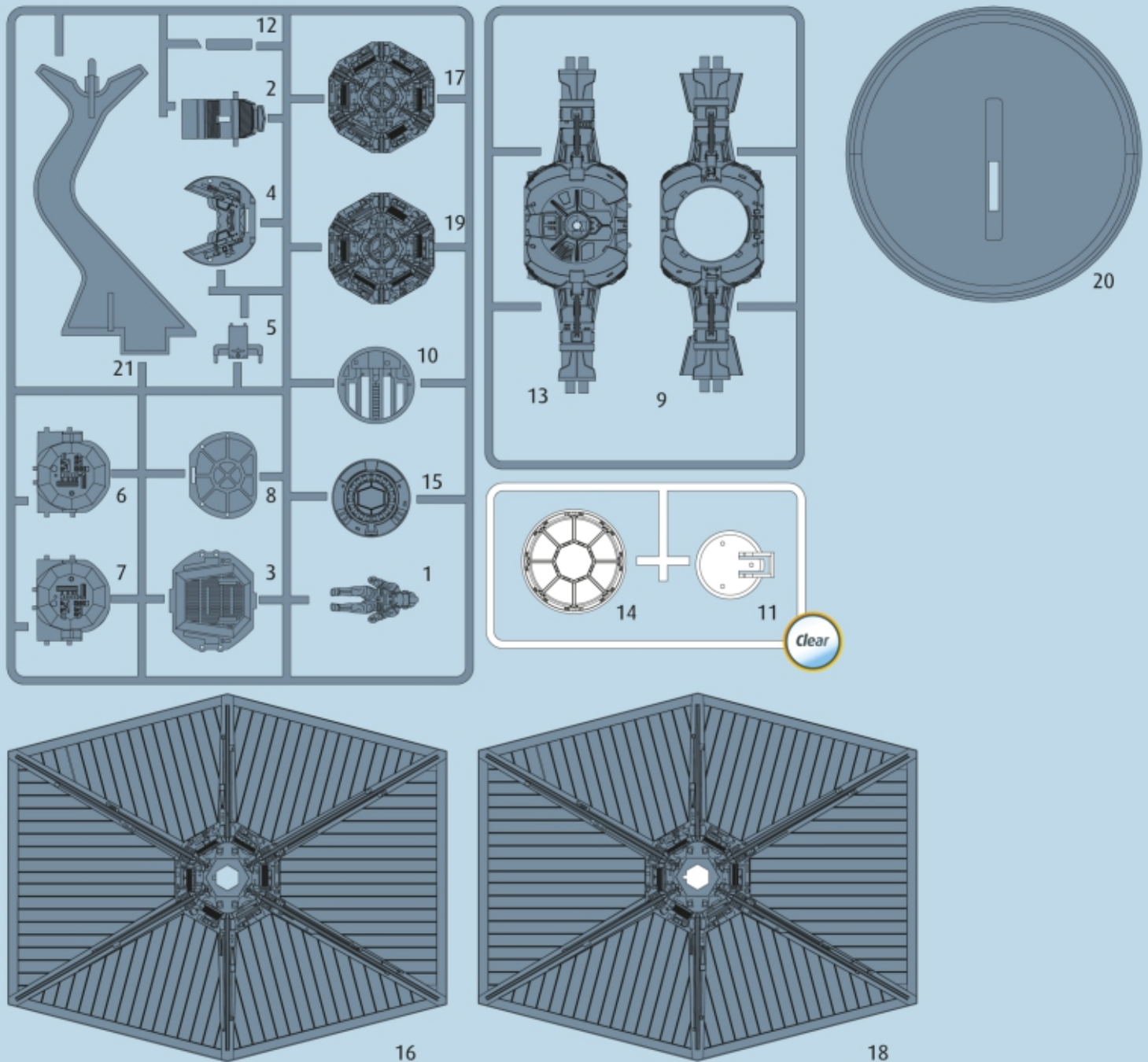

Ersatzteile benötigt?

Kein Problem. Einfach den Revell-Service mit Angabe von Artikel- und Teilenummer kontaktieren. Entweder unter service@revell.de oder Revell GmbH, Abteilung X, Henschelstr. 20-30, 32257 Bünde.*

*Wir bitten um Verständnis, dass eine Gewährleistung nur bei aktuellen Artikeln, die im Zeitraum der letzten 24 Monate erworben wurden, übernommen werden kann. Mit der Ersatzteil-Bestellung können Kosten z.B. für Verpackung und Versand entstehen. Ob diese Kosten anfallen wird im Vorfeld schriftlich durch unseren Service mitgeteilt. Das Angebot kann dann angenommen oder abgelehnt werden. Unfrei eingesandte Ersatzteil-Bestellungen werden von uns nicht angenommen! Dieser Direktservice gilt für die Länder Deutschland, Benelux, Österreich, Frankreich, Großbritannien. Ersatzteil-Bestellungen aus den übrigen Ländern werden über die jeweiligen Distributeure abgewickelt. Bitte kontaktieren Sie Ihren Händler.

Besoin de pièces de rechange ?

Il vous suffit de contacter le service Revell et d'indiquer la référence de l'article et de la pièce. Soit en écrivant par mail à france@revell.de (uniquement pour la France) ou par courrier à Revell GmbH, Département X, Henschelstr. 20-30, D-32257 Bünde.*

*La garantie s'applique pour les articles présents au catalogue et achetés au cours des 24 derniers mois. Merci de votre compréhension. La commande de pièces de rechange peut donner lieu à des frais supplémentaires, par ex. pour l'emballage et le port. Notre service client vous en informera au préalable par écrit. Vous pourrez accepter ou refuser le devis. Nous n'acceptons pas les commandes de pièces de rechange envoyées sans affranchissement ! Ce service direct est valable pour les pays suivants : Allemagne, Benelux, Autriche, France, Grande-Bretagne. Les commandes de pièces de provenance d'autres pays sont traitées par les distributeurs correspondants. Veuillez contacter votre revendeur.

Need spare parts?

No problem. Contact Revell Service with the item number and part numbers you need: service@revell.de or Revell GmbH, Unit 10, Old Airfield Industrial Estate, Cheddington Lane, Tring, Herts, HP23 4QR, Great Britain.*

*We request your understanding that a warranty can only be accepted for current articles which have been purchased in the last 24 months. Orders for spare parts may also be subject to costs for packaging and shipping. You will be notified in advance by our Service department if such costs are incurred. The offer can then be accepted or rejected. We will not be able to process any postal requests unless correct postage has been applied to mailing! This direct service applies to the countries: Germany, Benelux, Austria, France, and the United Kingdom. Spare part orders from other countries are processed by the local distributors. Please contact your dealer.

Hebt u reserveonderdelen nodig?

Geen probleem! Neem eenvoudig contact op met de klantenservice van Revell en geef ons het artikel- en onderdeelnummer door. U kunt ons bereiken op service@revell.de of per post: Revell GmbH, Afdeling X, Henschelstr. 20-30, 32257 Bünde.*

*Wij vragen uw begrip voor de omstandigheid, dat er alleen garantie kan worden geboden voor actuele artikelen, die in de afgelopen 24 maanden zijn gekocht. Met het bestellen van reserveonderdelen kunnen kosten gemoeid zijn, bijv. voor verpakking en verzending. U wordt vooraf schriftelijk door onze klantenservice op de hoogte gesteld als er kosten zouden ontstaan. Het aanbod kan dan worden aangenomen of afgewezen. Wij nemen geen ongefrankeerde bestellingen van reserveonderdelen aan! Deze rechtstreekse service wordt verleend in de landen Duitsland, de Benelux, Oostenrijk, Frankrijk en Groot-Brittannië. Bestellingen van reserveonderdelen in de overige landen worden afgewikkeld via de betreffende distributeurs. Neem hiervoor contact op met uw verkoper.

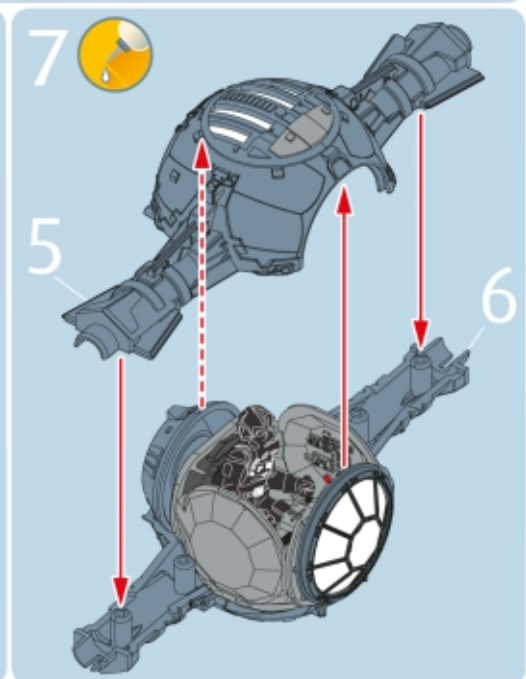
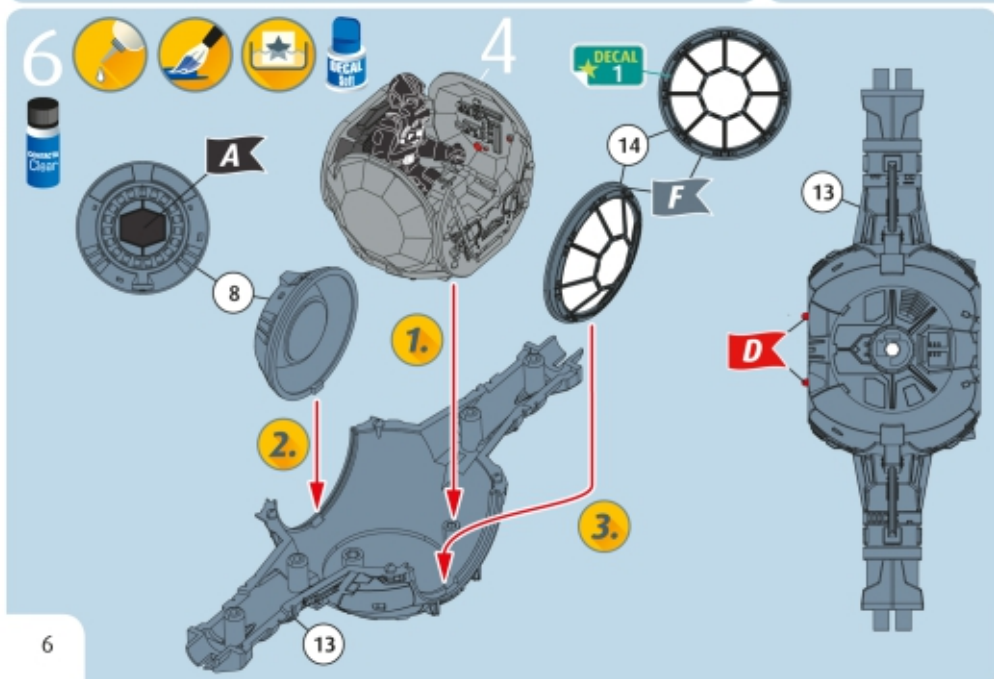
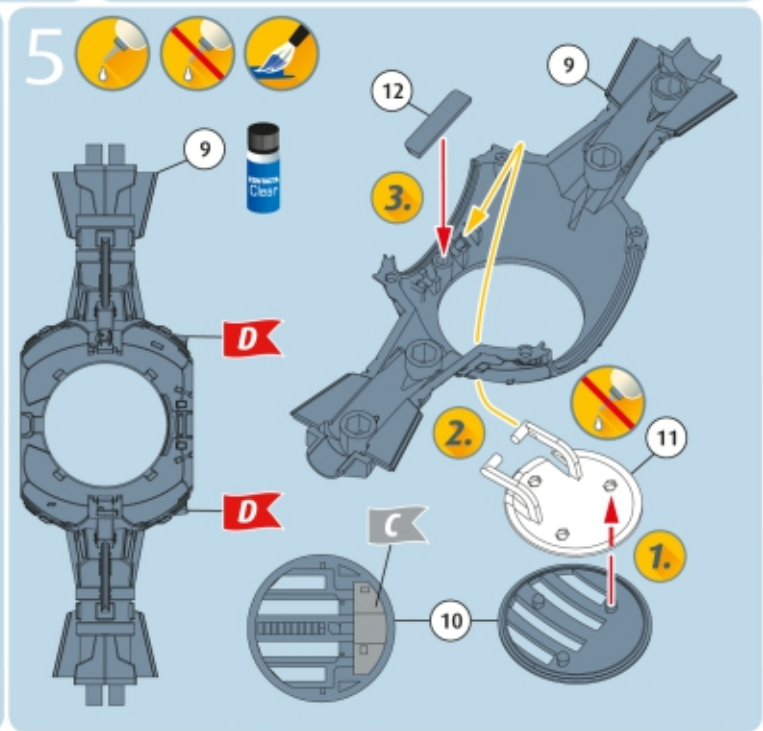
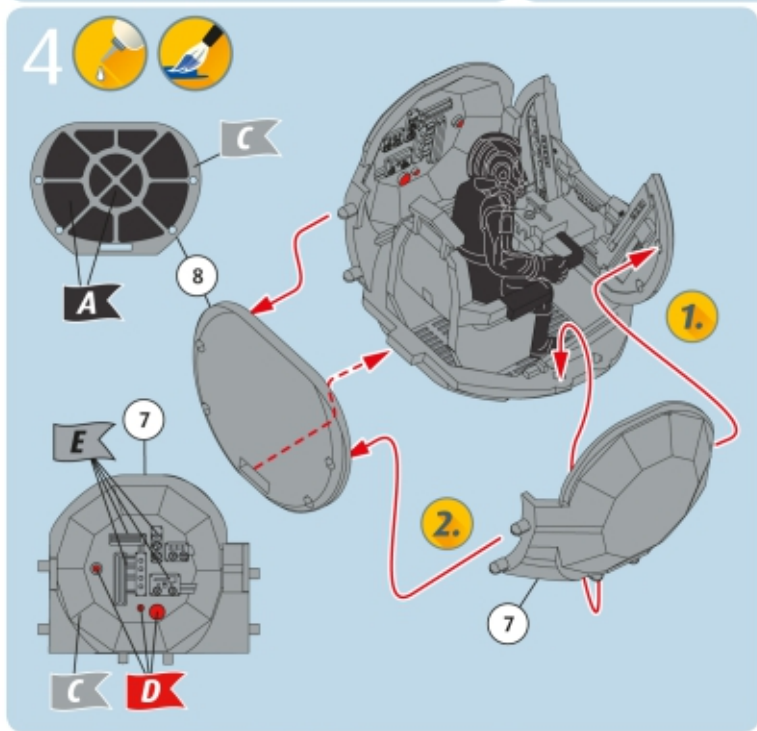
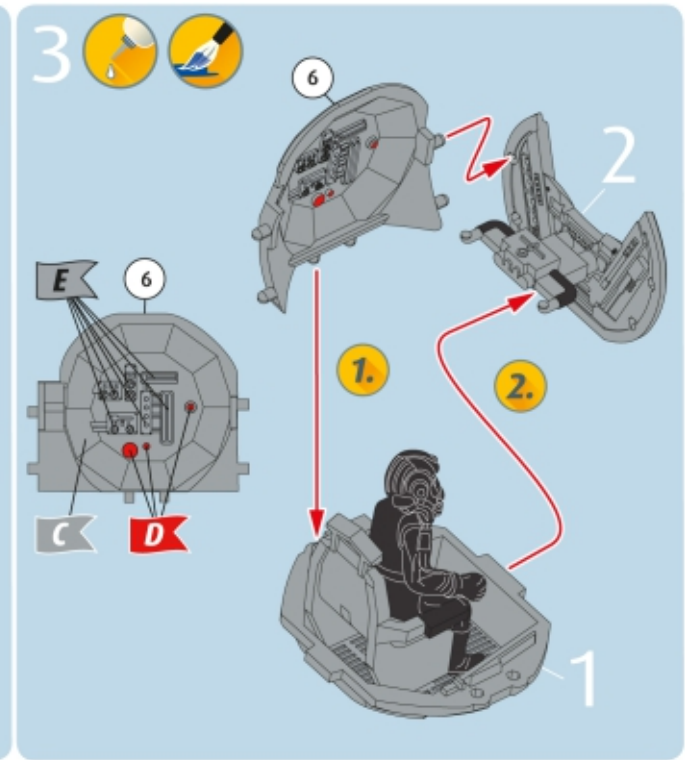
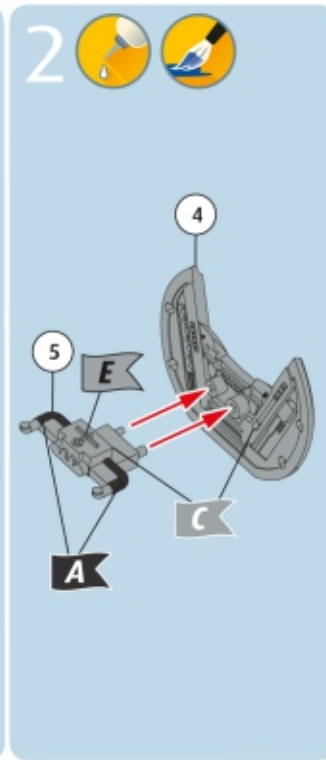
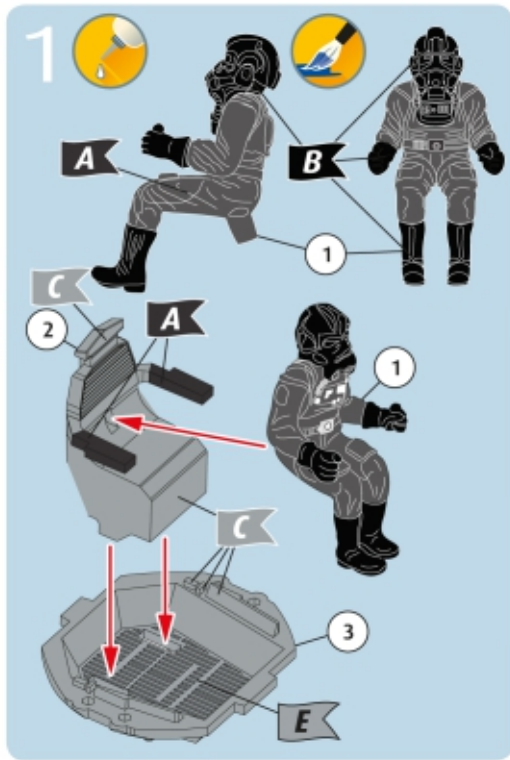

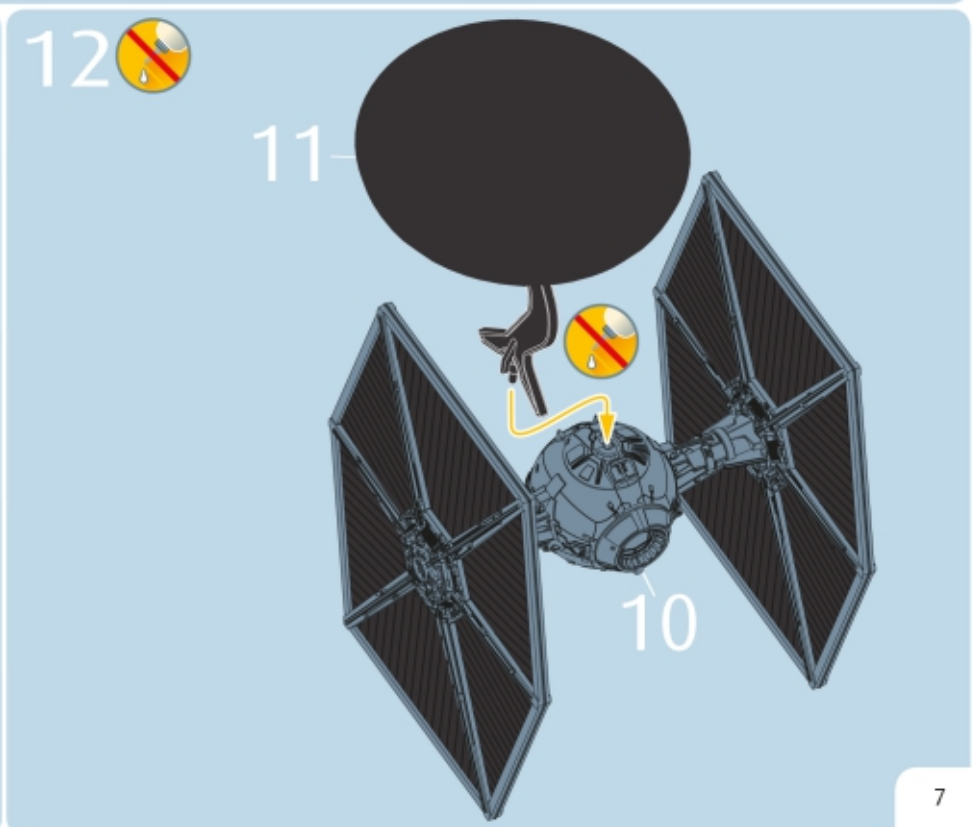
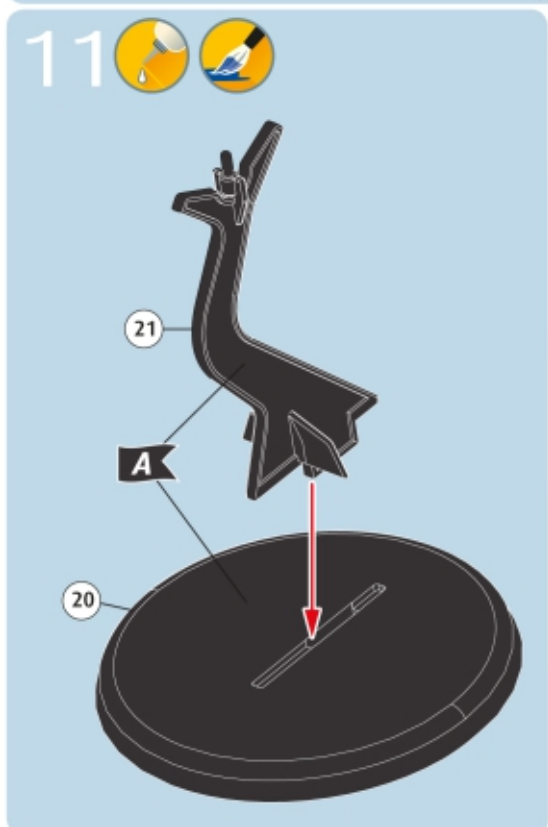
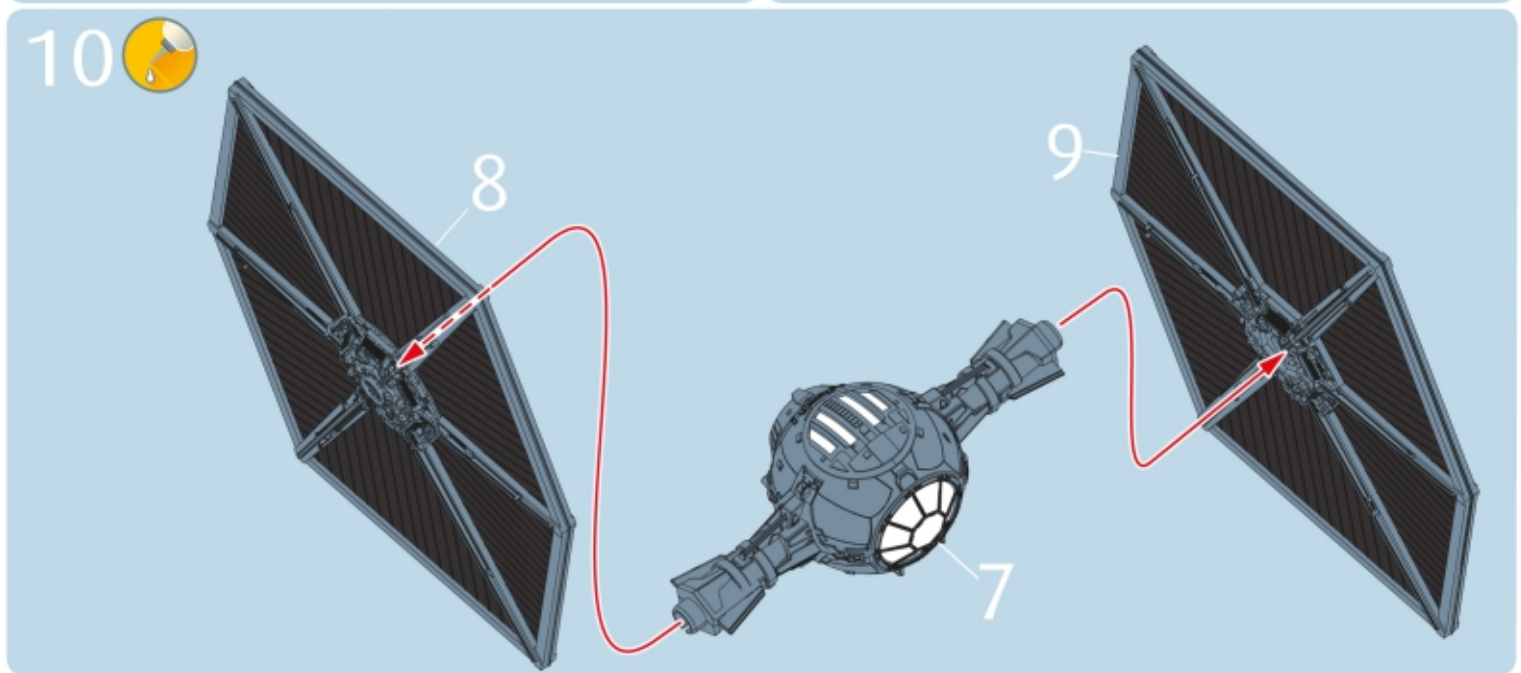
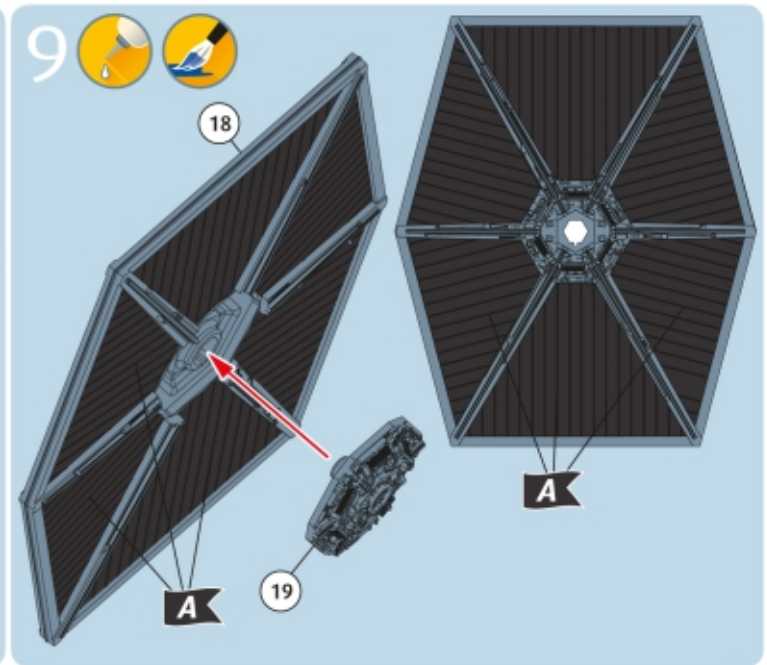
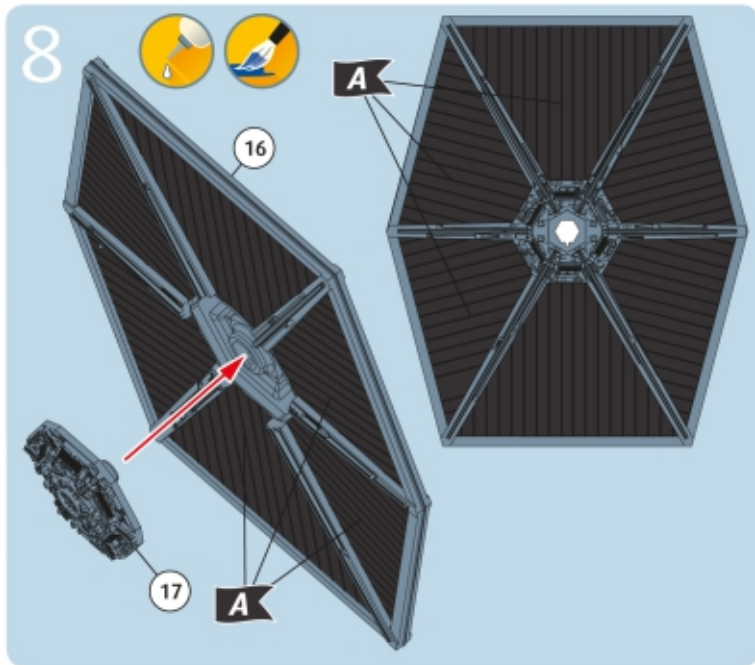



A
C
D

