

648 338 Spitfire Mk.VIII top cowl

for Eduard kit - pro stavebnici Eduard

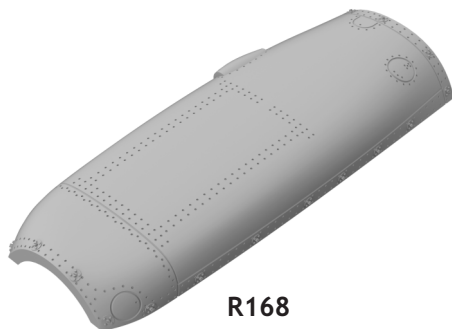

1/48 scale



R168

COLOURS

GSI Creos (GUNZE)		Mr.METAL COLOR	
AQUEOUS	Mr.COLOR		

This product contains metal and resin detail parts for upgrading scale plastic models. When selecting this set make sure that it is for the kit mentioned in product name as these sets are made specifically for that kit. When upgrading the model some cutting or corrections may be necessary for parts to fit accurately. **WARNING!** This set contains small and sharp parts. Work carefully in a ventilated and well-lit room. Safety glasses are recommended. This product is not suitable for children below 14 years of age.

Tento výrobek obsahuje lepané a odlévané detaily pro úpravu a vylepšení plastického modelu. Při výběru sady kovových detailů zkontrolujte, zda je určena pro model, který chcete upravit. Model, pro který je sada určena, je uveden u názvu výrobku. Pro přesnou aplikaci kovových a odlévaných dílů může být zapotřebí upravit díly upravovaného modelu. **POZOR!** Sada obsahuje malé ostré díly. Pracujte ve větrané a dobře osvětlené místnosti. Doporučujeme použití ochranných brýlí. Tento výrobek není vhodný pro děti mladší 14 let.



435 21 Obrnice 170
Czech Republic



www.eduard.com









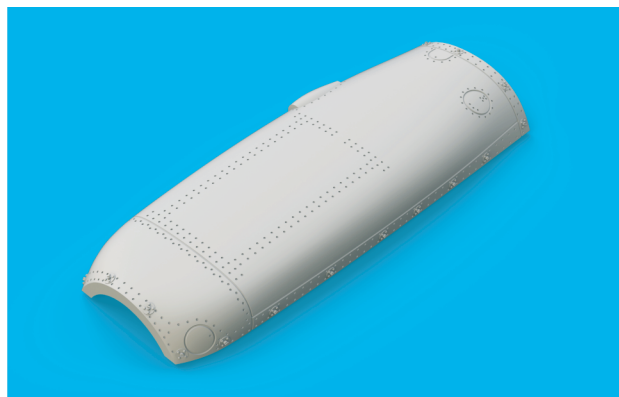
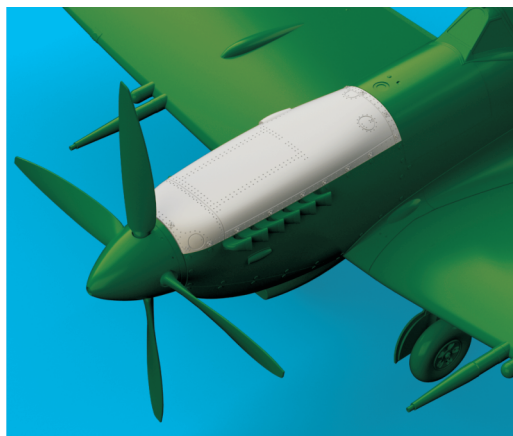

648 338 Spitfire Mk.VIII top cowl

for Eduard kit - pro stavebnici Eduard

1/48



BEST ~~BRASS~~ RESIN AROUND!

 REMOVE ODSTRÁNIŤ	 BEND OHNOUIT	 SYMMETRICAL ASSEMBLY SYMETRICKÁ MONTÁŽ
 GRIND OBROUSIT	 OPTION VOLBA	 SCRIBE THE PANEL AND HOLES RYTI
 DRILL HOLE VRTAT OTVOR	 REPLACE NAHRADIŤ	 REVERSE SIDE OTOČIT

