

Hawker Sea Fury:

Iraq/Pakistan/Egypt

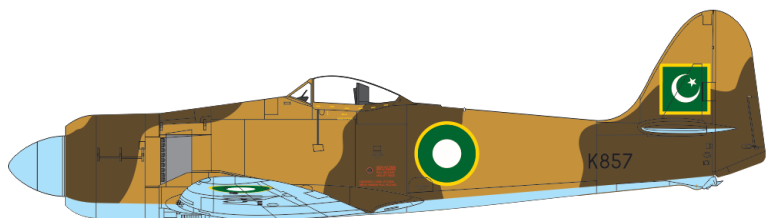

Download full guide from guide from www.uprise-decal.com

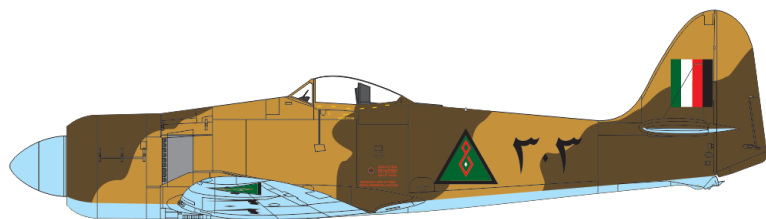
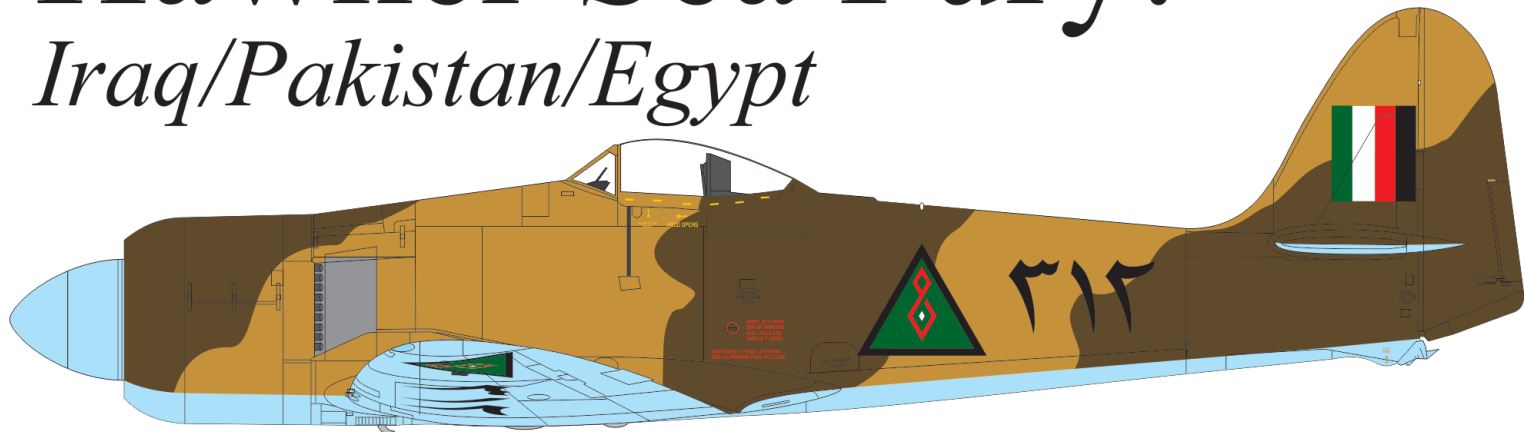
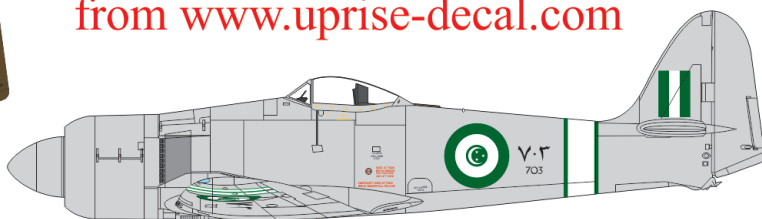

- UR72290
- UR48290
- UR32290

- UR24290
- UR144290

P-51D-5/10 MUSTANG

A P-51D-5NA,
1944, 79 FS, 20 FG, 8 AF,
USAAF, olive drab top
of the wing and
horizontal stabilator.



Download full guide from www.uprise-decal.com

B P-51D-5NA,
July 1944, 487 FS,
352 FG, 8 AF,
USAAF, Bodney UK
invasion stripes
only on bottom.

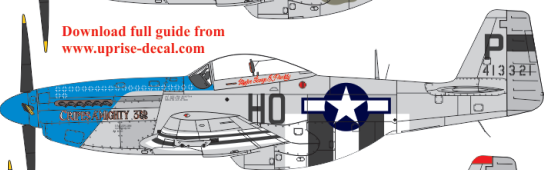

C P-51D-10NA,
July 1944, 487 FS,
361 FG, 8 AF,
USAAF, Essex UK
early invasion
stripes over
the wing and
horizontal stabilator.

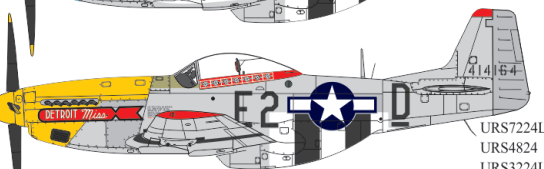

- URS7224L
- URS4824
- URS3224L

D P-51D-5NA,
July 1944, 375 FS, 361 FG, 8 AF,
USAAF, Dark Green top
of the wing and
horizontal stabilator.

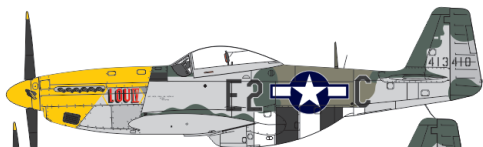

E P-51D-5NA,
July 1944, 375 FS, 361 FG, 8 AF,
USAAF, Dark Green top
of the wing and horizontal stabilator.
Invasion stripes on bottom of the wing.



F P-51D-5NA,
1944, 368 FS, 359 FG, 8 AF,
USAAF, early invasion
stripes over the wing and horizontal
stabilator.

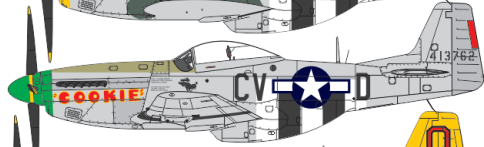

G P-51D-5NA,
Autumn 1944, 2 FS, 52 FG,
USAAF, Italy, early invasion
stripes (Yellow colour) over
the wing.



BELL P 39 AIRACOBRA В СССР IN USSR 16 Гвардейский истребительный авиационный полк 16 Guards Fighter Air Regiment



- UR72237
- UR48237
- UR32237

Download full guide from www.uprise-decal.com

Ju-87G-1/2 Hans-Ulrich Rudel

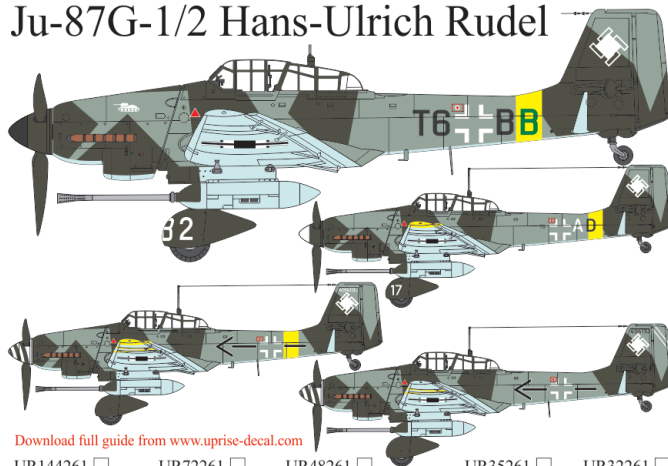

Download full guide from www.uprise-decal.com

- UR144261
- UR72261
- UR48261
- UR35261
- UR32261

A/B. Hawker Sea Fury F.1 "Baghdad Fury", Iraq, 1946-1951.

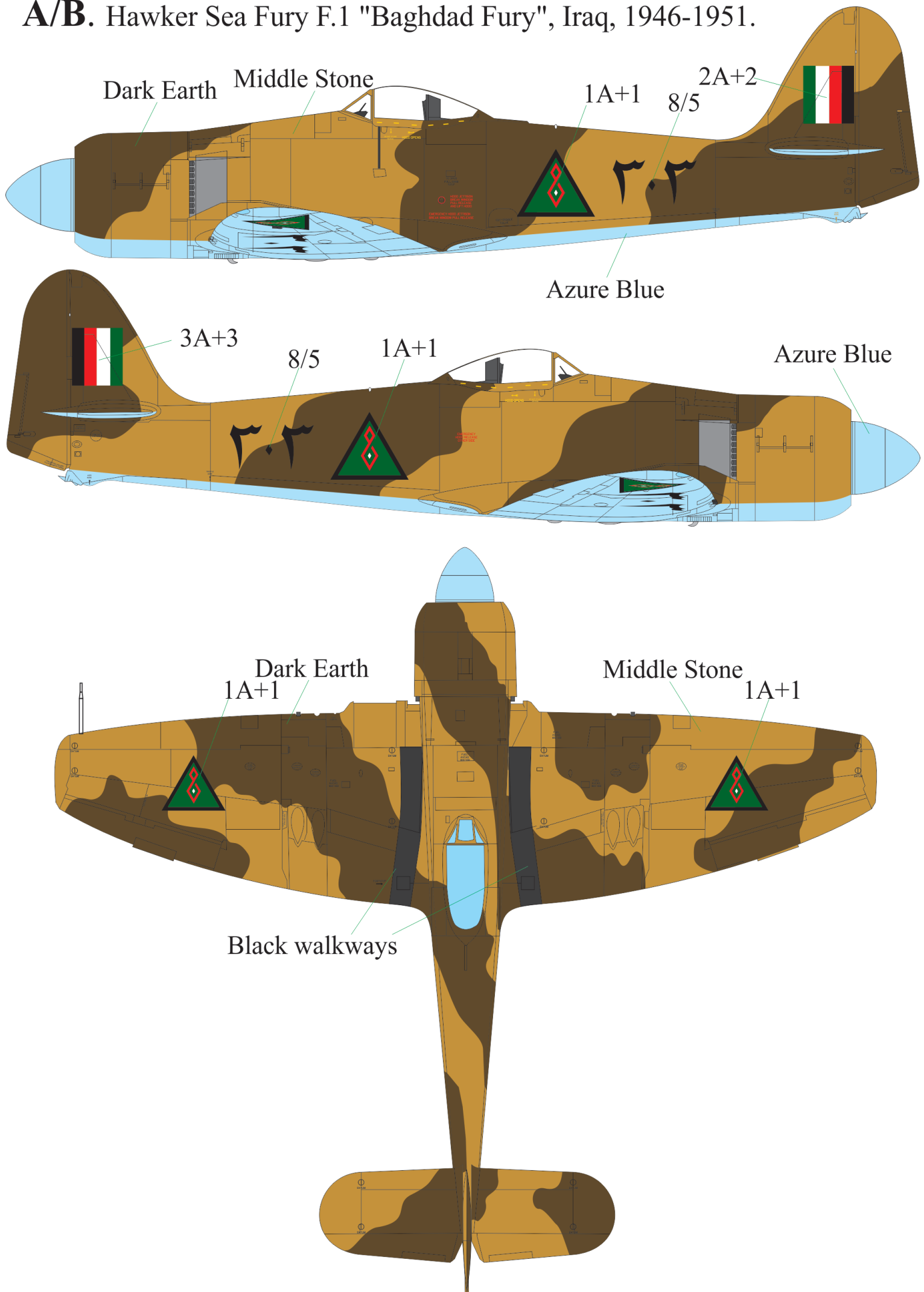

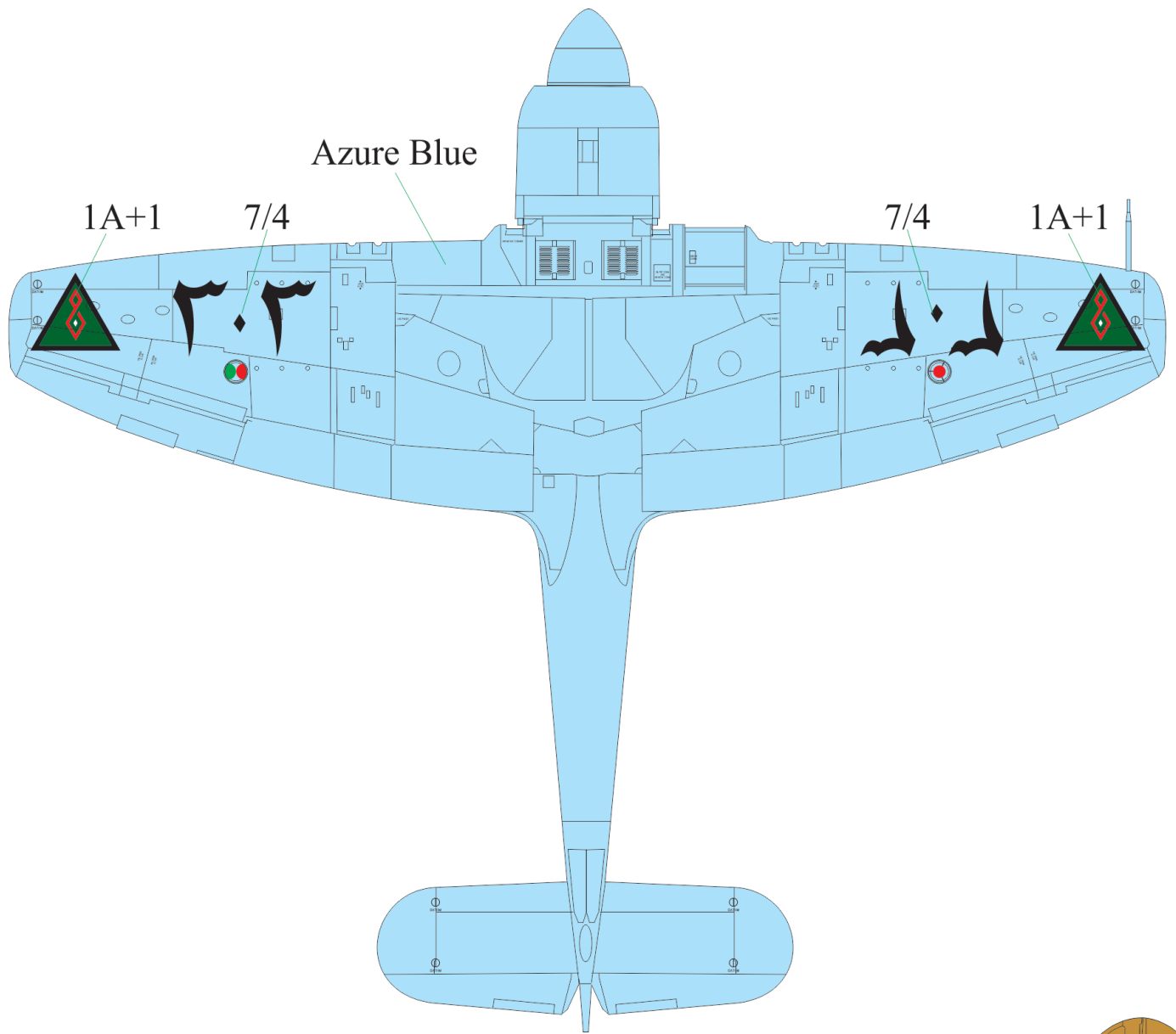

C. Hawker Sea Fury FB.60, Pakistan, 1950-1952.

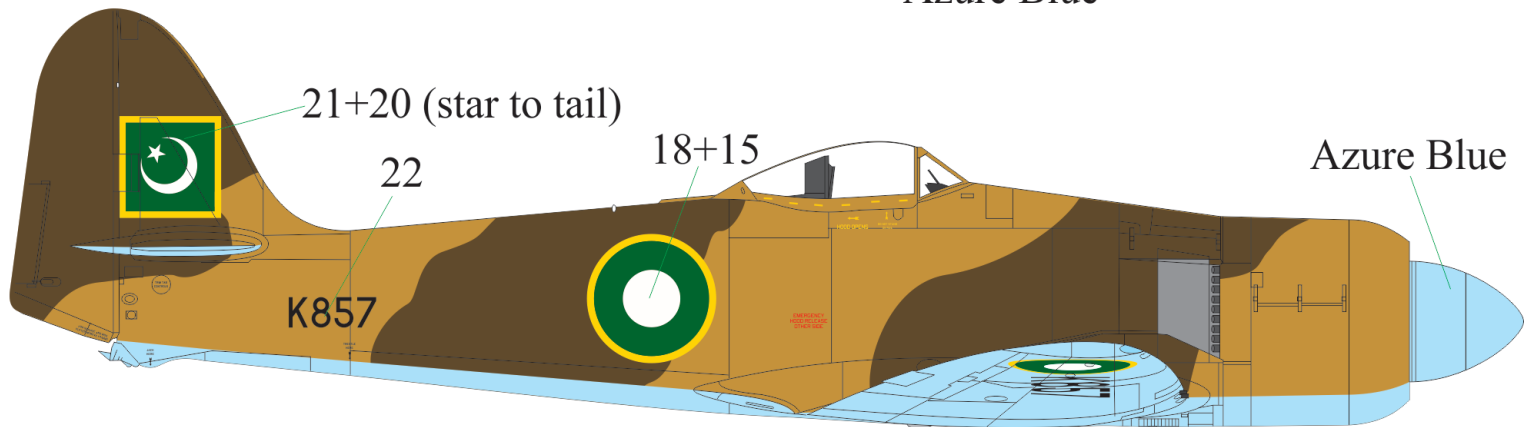
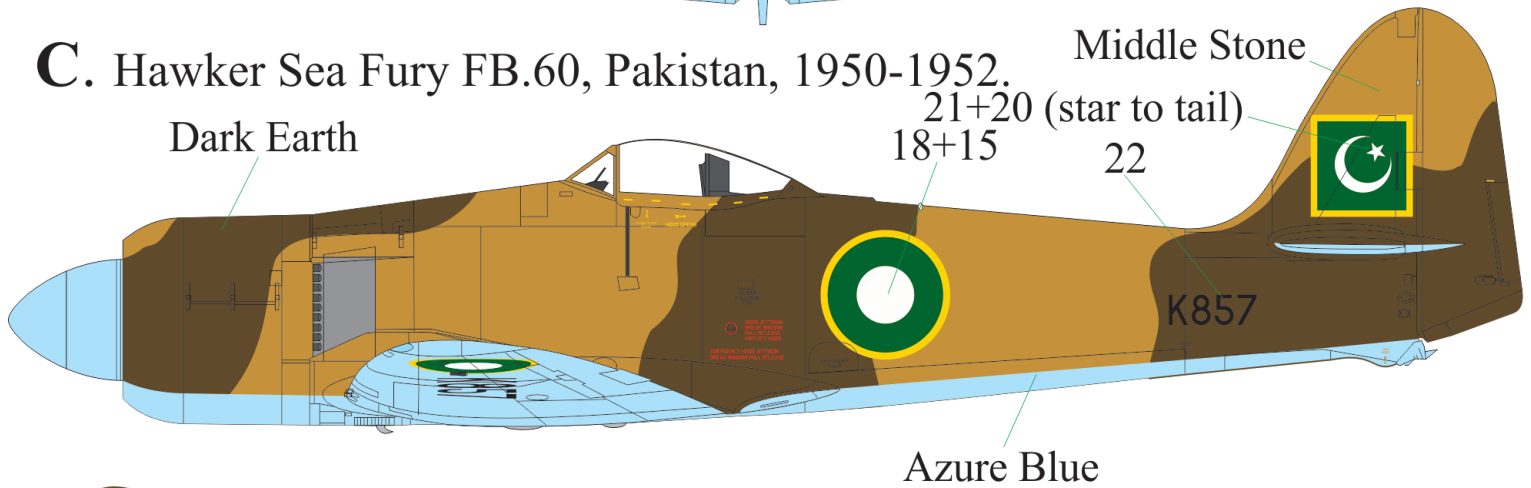

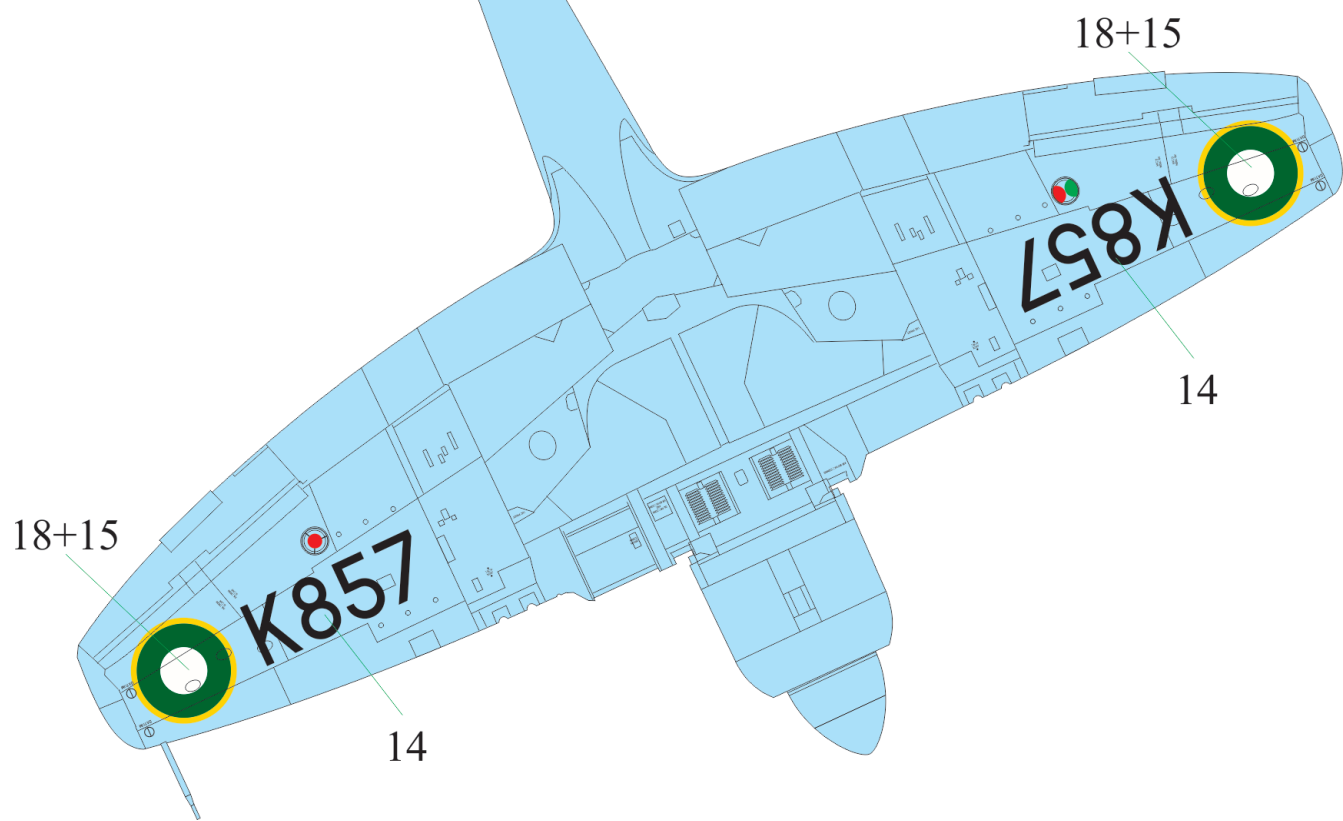
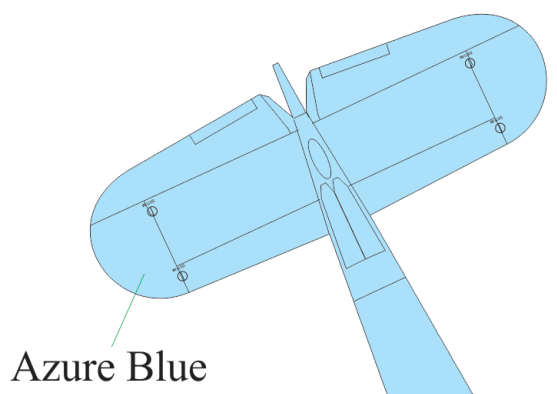
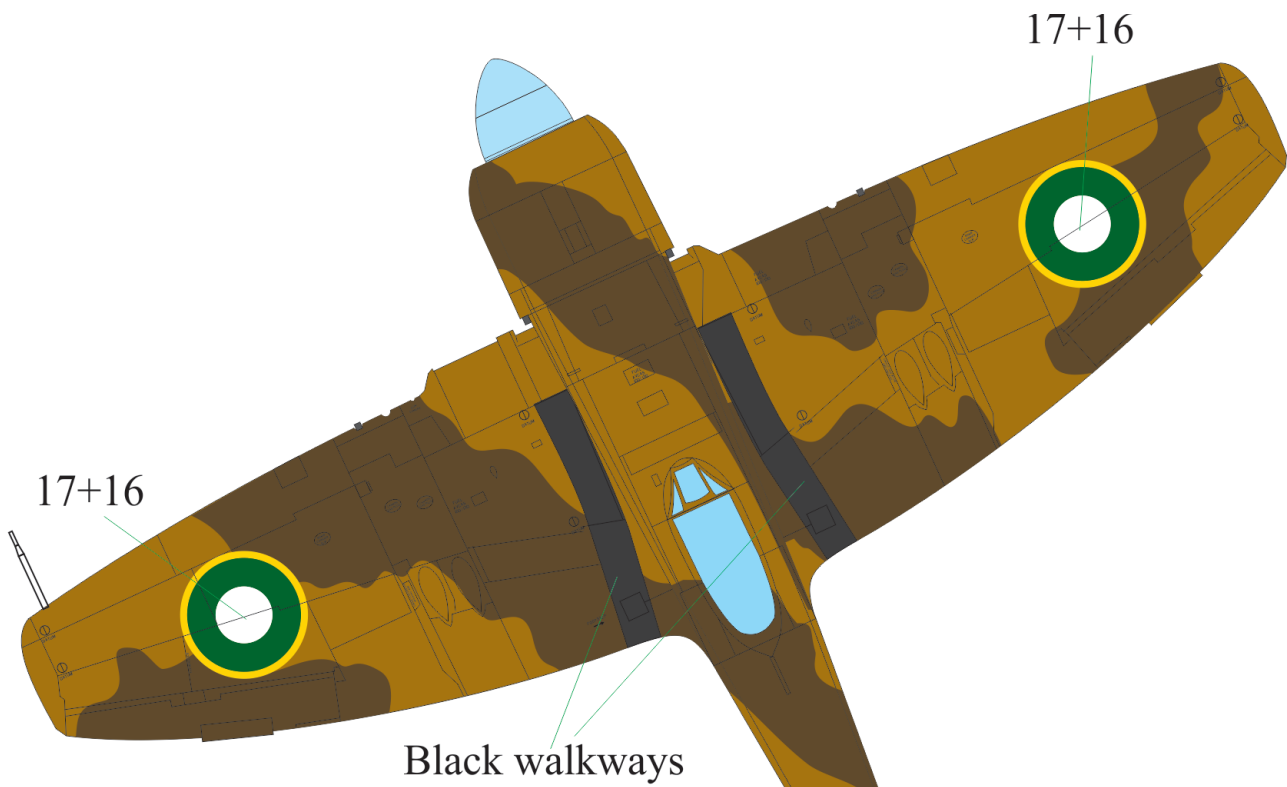

C. Hawker Sea Fury F.1, Egypt, 1950-1951.

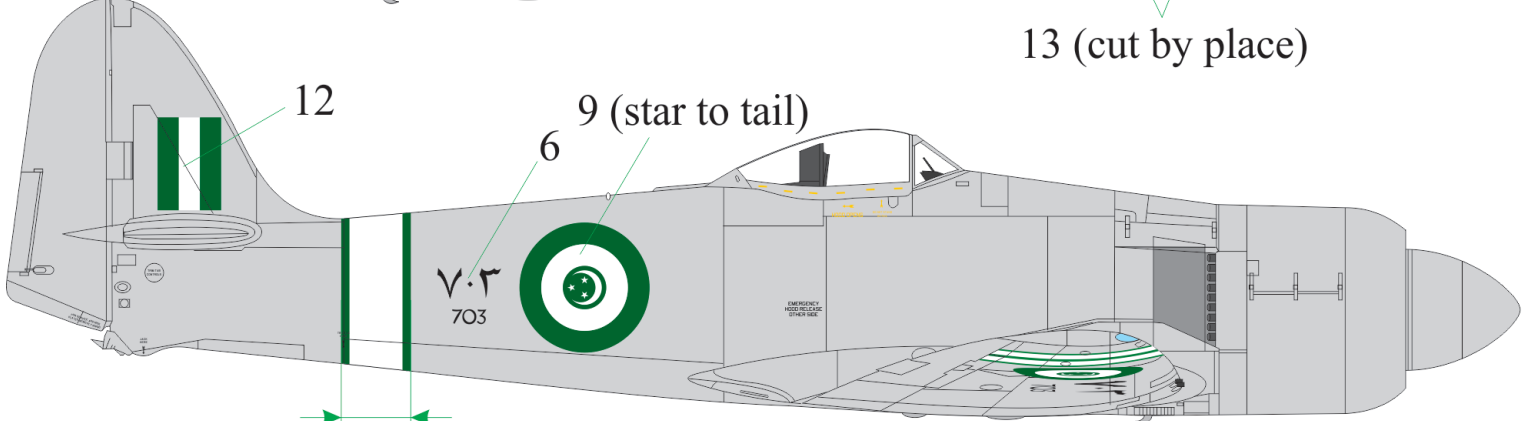
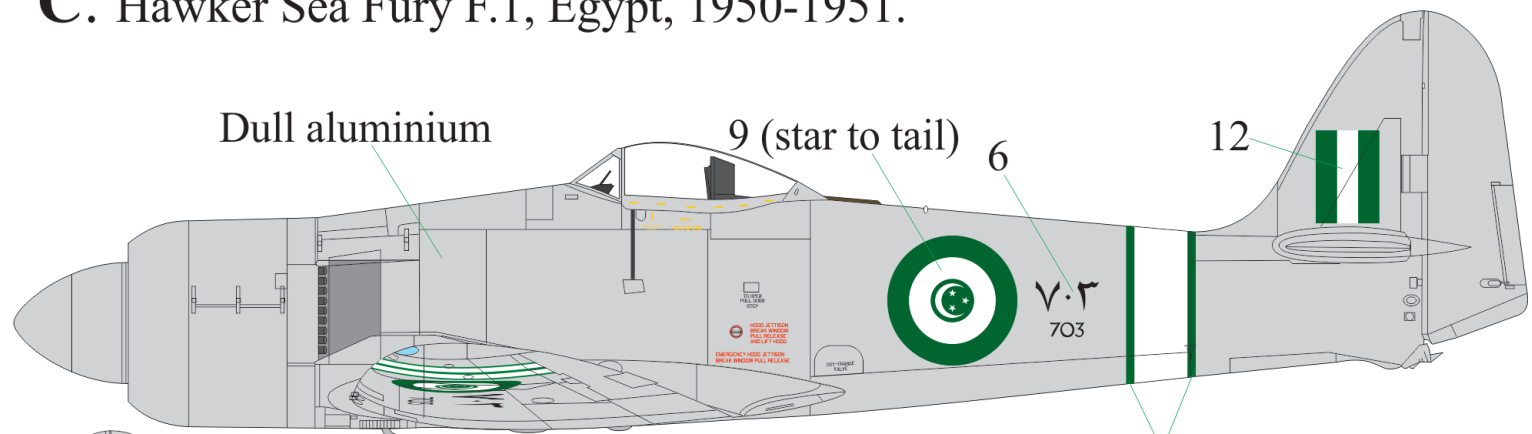

15 mm for 32 scale
 10 mm for 48 scale
 6,6 mm for 72 scale

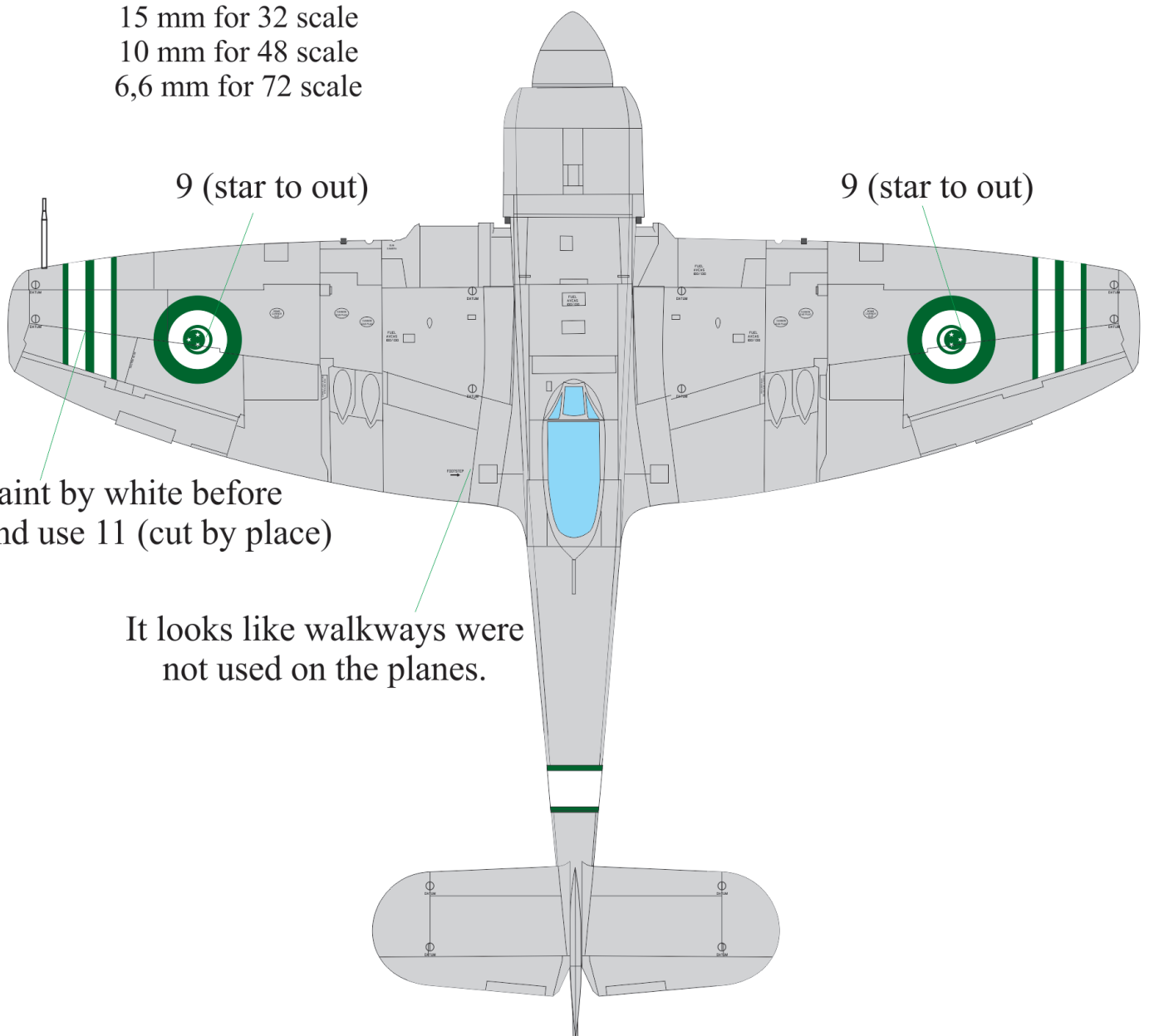

Paint by white before
 and use 11 (cut by place)

It looks like walkways were
 not used on the planes.

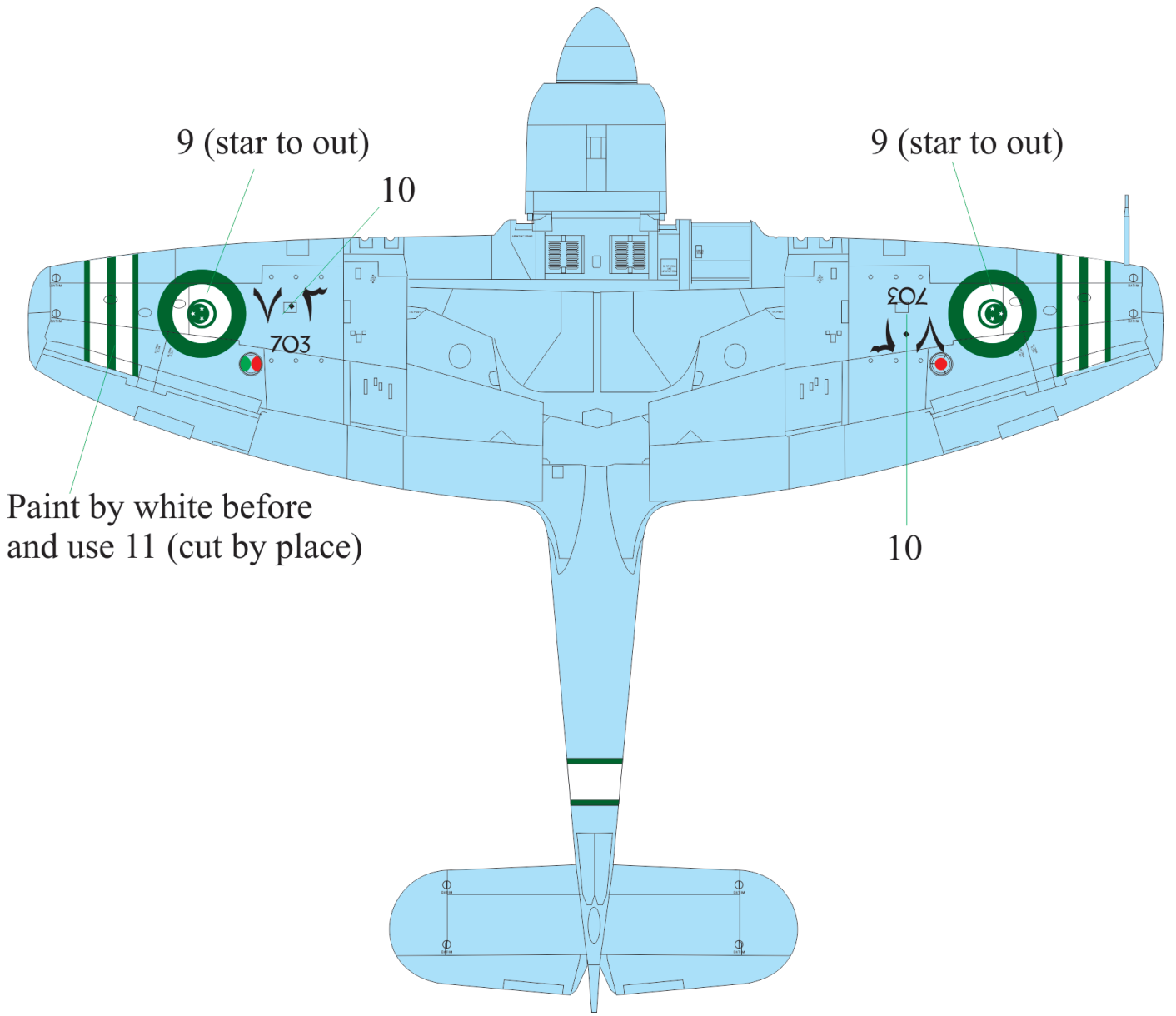

9 (star to out)

10

9 (star to out)

Paint by white before
and use 11 (cut by place)

10

Hawker Sea Fury Stencils

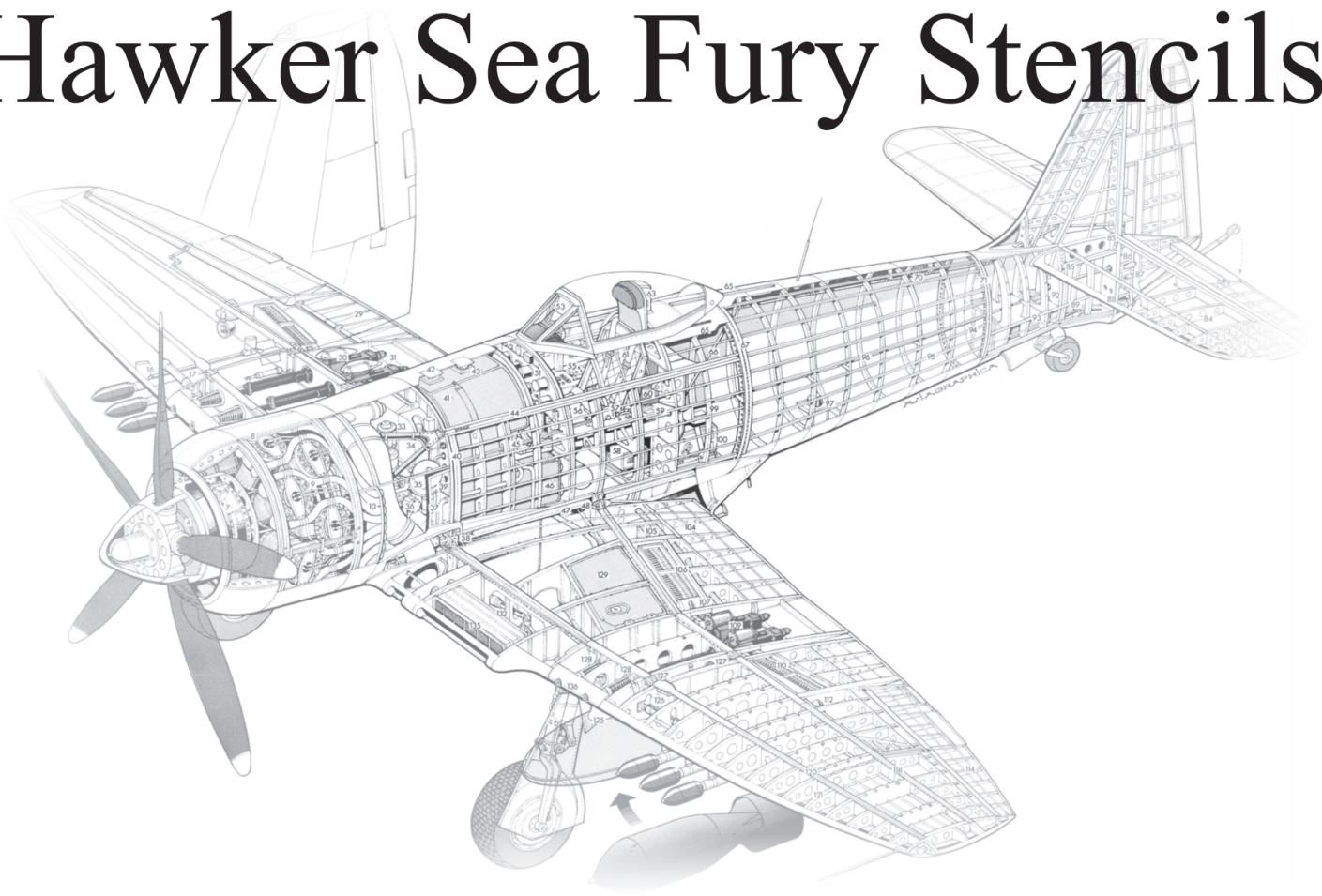

UR72288

UR48288

UR32288

F6F-3K/5K Hellcat Drones

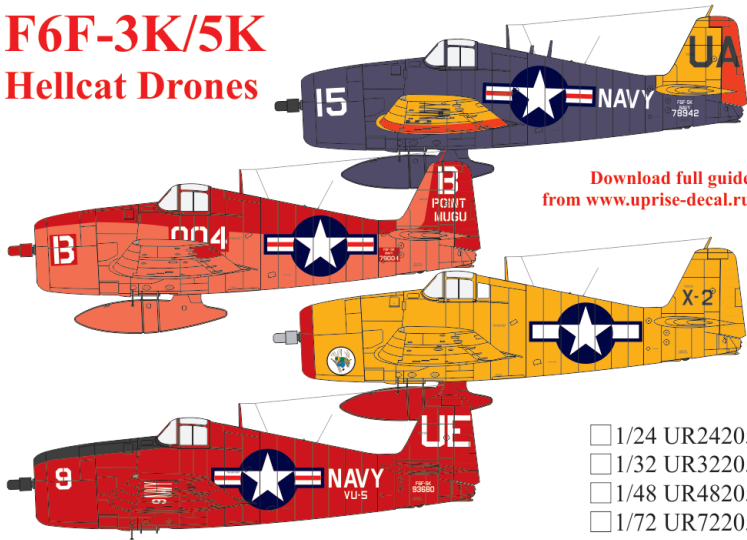

Download full guide from www.uprise-decal.ru

- 1/24 UR24205
- 1/32 UR32205
- 1/48 UR48205
- 1/72 UR72205

Fairey Swordfish Mk I, 824/810 NAS FAA HMS Eagle & Courageous, pre-WW2

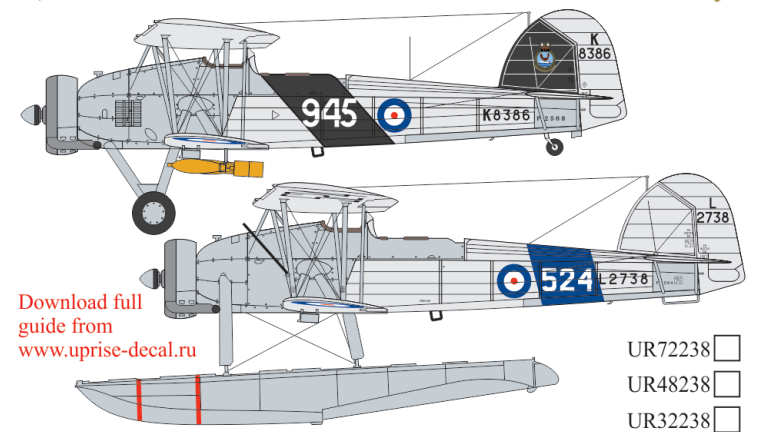

Download full guide from www.uprise-decal.ru

- UR72238
- UR48238
- UR32238

Bell P-400 Airacobra "Air-A-Cutie"

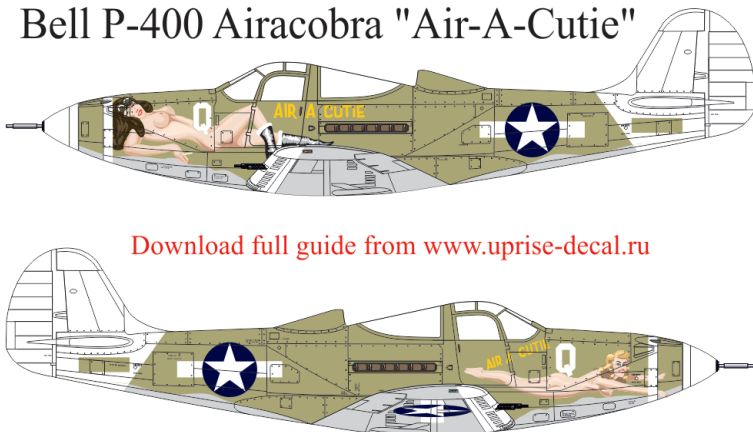

Download full guide from www.uprise-decal.ru

- UR144239
- UR72239
- UR48239
- UR32239

P-51B/C Mustang *Blue Nose Bastards*

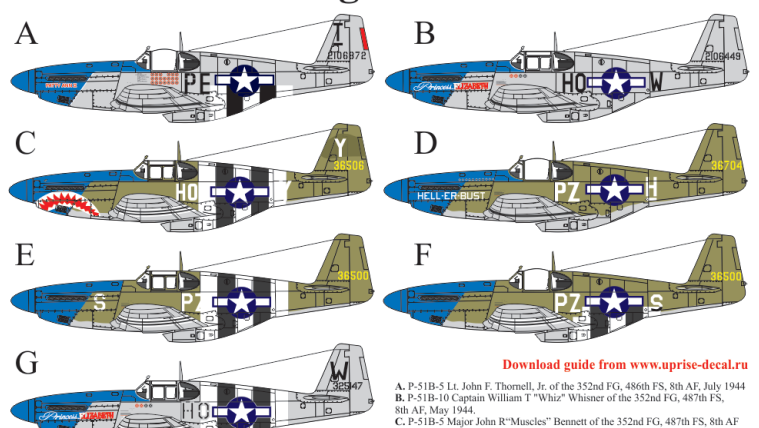

Download guide from www.uprise-decal.ru

- UR144228
- UR72228
- UR48228
- UR32228
- UR24228

A. P-51B-5 Lt. John F. Thornell, Jr. of the 352nd FG, 486th FS, 8th AF, July 1944
 B. P-51B-10 Captain William T "Whiz" Whisner of the 352nd FG, 487th FS, 8th AF, May 1944.
 C. P-51B-5 Major John R "Muscles" Bennett of the 352nd FG, 487th FS, 8th AF
 D. P-51B-5 Lt. Ed Heller of the 352nd FG, 487th FS, 8th AF, May 1944
 E. P-51B-5 Lt. Stanley "Stan" Miles of the 352nd FG, 486th FS, 8th AF, June 1944
 F. P-51B-5 Lt. Stanley "Stan" Miles of the 352nd FG, 486th FS, 8th AF, 1944.
 G. P-51C-15 May 2007, painted as P-51B of Capt. William T "Whiz" Whisner.

Stencils placement

