

1:72 SCALE

ITEM NO.:07253

Drehkraftwagen Sd.Kfz.9/I early version

Sd.Kfz.9/I 工程车 早期型

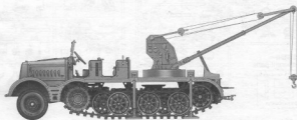

READ BEFORE ASSEMBLY:

- This kit is not recommended for inexperienced modelers or for children under 14 years of age
- Study and understand these instructions thoroughly before beginning assembly
- When needed, remove photo-etch parts carefully using a modeling knife or photo etch sprue cutter, being careful not to damage or lose small parts.
- Take extra care in handling photo etch parts in order to avoid injury
- Apply instant cement sparingly to photo etch parts where instructed
- Tools recommended(not included in kit):Plastic and instant cements,sprue cutters,long nose pliers,modeling knife, small files, tweezers, pin vise & scissors. Soft cloth and sandpaper will also assist in construction
- Glue and paint are not included in the kit. Use plastic cement and hobby paints only. Color guide for purchasing paint is included in the kit.
- Keep out of reach of children. They must not be allowed to ingest small parts or handle plastic bags in any way.

装配之前仔细阅读

- 小心用模型锉刀锉平所有零件表面的注射浇口。
- 小心用刀片切下蚀刻片零件，不要遗失小零件。
- 用强力的快干胶水粘合蚀刻片零件和金属脚，过量的快干胶水使用可能导致零件会粘住，小心涂胶。
- 取蚀刻片时应特别注意安全，防止利刃划伤手指。
- 某些零件表面需贴水贴纸，请选择在装配的同时进行。
- 推荐模型工具(自备)：胶水，水口剪刀，长嘴钳，刀片，挫刀，镊子，钳，锯，剪刀，瞬间快干胶。
- 软布和砂纸同时也应该是必备工具。
- 请使用塑料胶水和油漆，模型内不含。
- 谨防小孩吸取零件和零件，或者将塑料袋套在头上，制作时应将器材远离小孩接触。
- 本产品不适合14岁以下没有经验的模型爱好者。



cyanocrylate glue
使用强力胶



weight
配重



make hole
钻孔



cut / remove
切除



bend
弯曲



file / sand
锉平



option
选择



no cement
不涂胶水



decal
贴纸

水贴纸的使用:

1. 从水贴纸上剪下印花;
2. 将印花放入温水中浸10秒, 然后放在干净布上.
3. 拿着印花纸板将印花移到模型上;
4. 手指蘸水将印花移到适当的位置;
5. 用软布轻压印花直至水平, 气泡消失.

DECAL APPLICATION

1. Cut off decal from sheet.
2. Dip the decal in tepid water 40°C for about 10 sec. and place on a clean cloth.
3. Hold the backing sheet edge and slide decal onto the model.
4. Move decal into position by wetting decal with finger.
5. Press decal gently down with a soft cloth until excess water and air bubbles are gone.
6. Allow decal to dry completely before handing model.

部品图 Parts

A



<<透明部品>>
Transparent parts



F

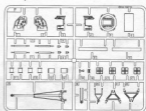

Bx2



C

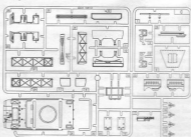

D

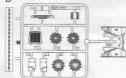

<<车架>>
Chassis

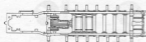

Ex4



<<钢丝绳>> $\phi 0.5 \times 800\text{mm}$
Rope



<<轮胎>> x3
Tire



<<水贴>>
Decal



<<履带>>
Track



不用部品: B1.B19.B22.C6.C7.C11.C12.C27.C29.F3.F4.F6.F21.
Unused parts

1 底盘组装
Chassis assembly

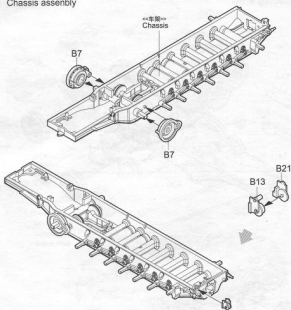

2 车轮组装
Wheel assembly



3 发动机组装
Engine assembly

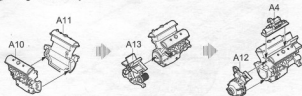

4

车轮安装
Attaching wheel

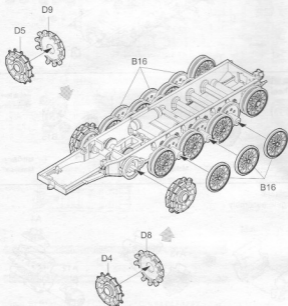
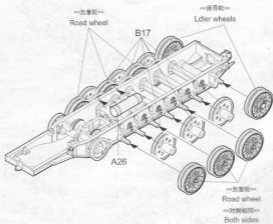

5 发动机安装
Attaching enging

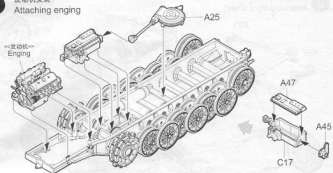

6 排气管安装
Attaching exhaust

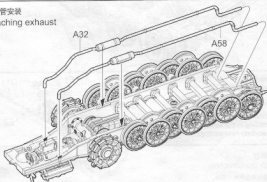

7 绞盘安装
Attaching winch

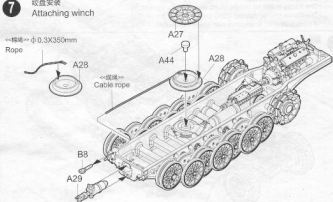

8

前轮安装 Attaching front wheel

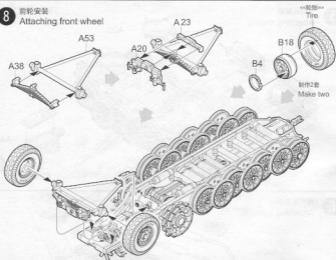

7

履带组装 Track assembly

根据实际需要选择履带节数。(47-49节)
Choose the track stanza the number
according to the actual request.(forty
seven-forty nine section)



7

履带联接 Track construction

- * 履带可用塑料胶水粘合。
- * 履带可用模型油漆喷涂。
- * 若履带断裂，用细铁丝固定。
- * The tracks in this kit can be glued using plastic cement.
- * The tracks can be painted using plastic paints.
- * If track is broken strengthen with staples or thread.



9

履带安装 Attaching tracks

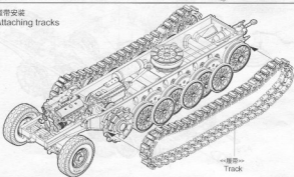

10 駕駛室組裝
Cab assembly

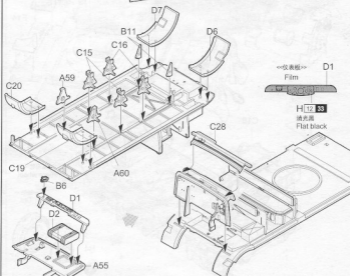
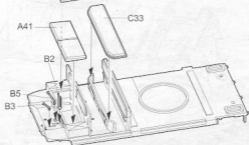
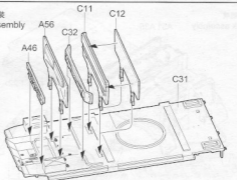

11

车棚组装
Tunk assembly

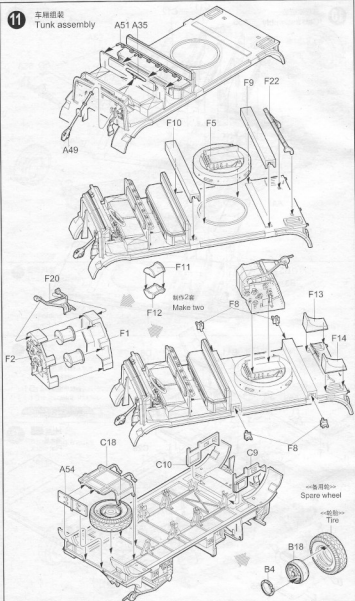

12

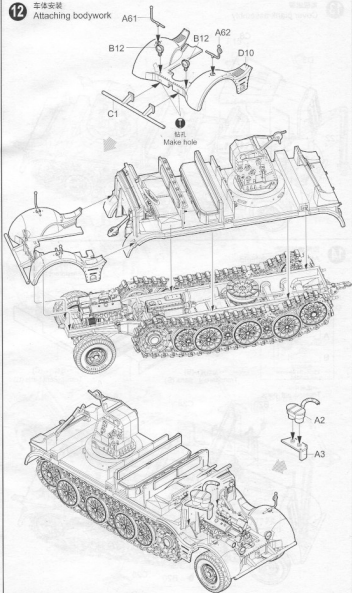
车体安装
Attaching bodywork

13 盖板组装
Cover plank assembly

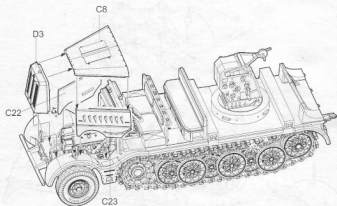

14 挡风玻璃安装
Attaching windshield

用剪刀剪下透明片 A B C

Cut out Transparent part A B C

07203 1/72 sd.kfz.9

A

B

©2008TRUMPETER

<<透明片>>
Transparent parts

A36

<<透明片>>(B)

Transparent parts (B)

<<透明片>>(A)

Transparent parts (A)



<<透明片>>(C)

Transparent parts (C)

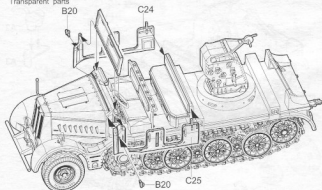

15

车体安装
Attaching bodywork

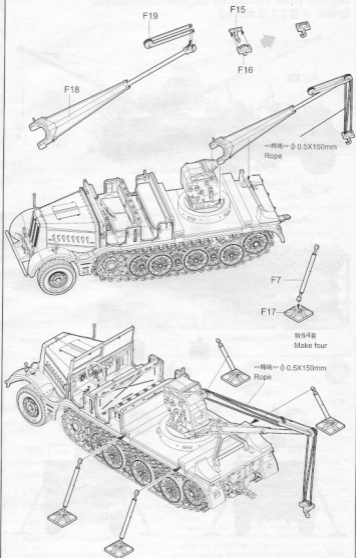

涂装同标贴指示
Painting & Marking guide

使用 MR.HOBBY 涂料 Mr. Color used

H 33 40 MR Field grey HCT 85 MR The Black

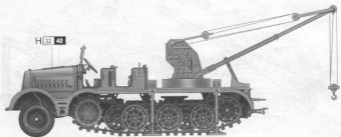

H 77 137

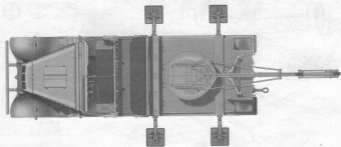

H X AQUEROUS HOBBY COLOR

Mr. COLOR