

1/35 MILITARY MINIATURE VEHICLE UPGRADE SERIES PE35245









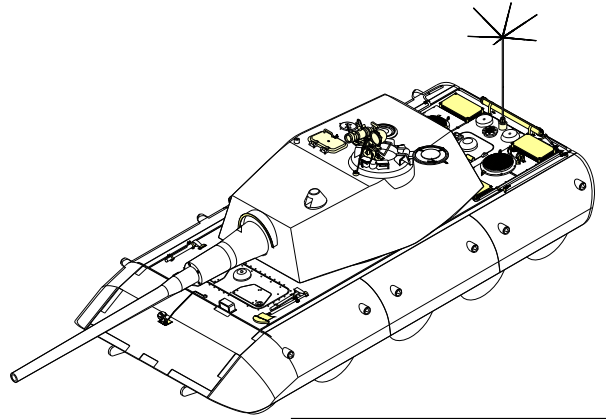
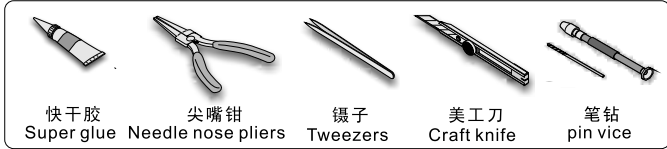

WWII German E-100

二战德军E100型计划战车改造件

[For Tumpeter 00384]

推荐使用工具 RECOMMENDED TOOLS



- 
 安装
install
- 
 折叠
bend
- A1**
 改造件零件编号
PE/resin part number
- B12**
 原零件编号
kit part number
- C22**
 被替换的原零件编号
replaced kit part number
- 
 另一侧相同制作
repeat on opposite side
- 
 切除
remove
- 
 打磨
grind off
- 
 弧度卷曲
radial bending
- 
 制作若干组
multiple assembly
- 
 选择安装
alternative
- 
 钻孔
drill
- 
 填补
fill

 用尖端在凹槽处冲压
use penpoint to press on the dent

蚀刻片零件内朝面向上
Put the part upside down
 用笔尖在凹槽处刺
Use penpoint to press on the dent

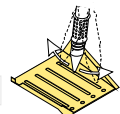
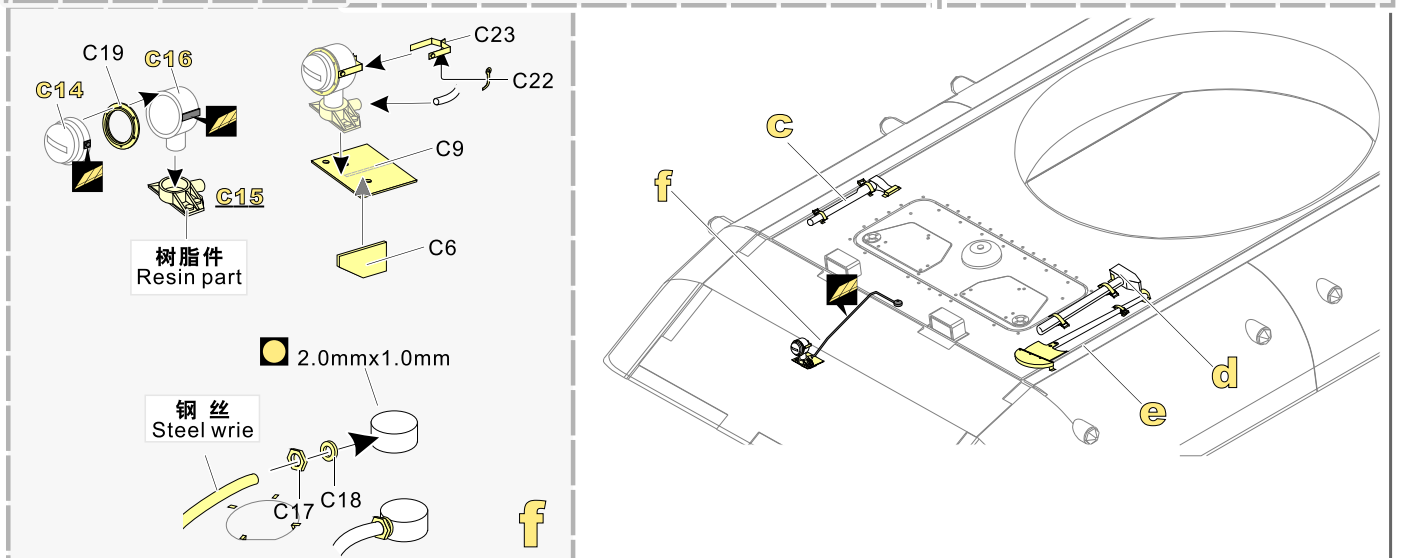
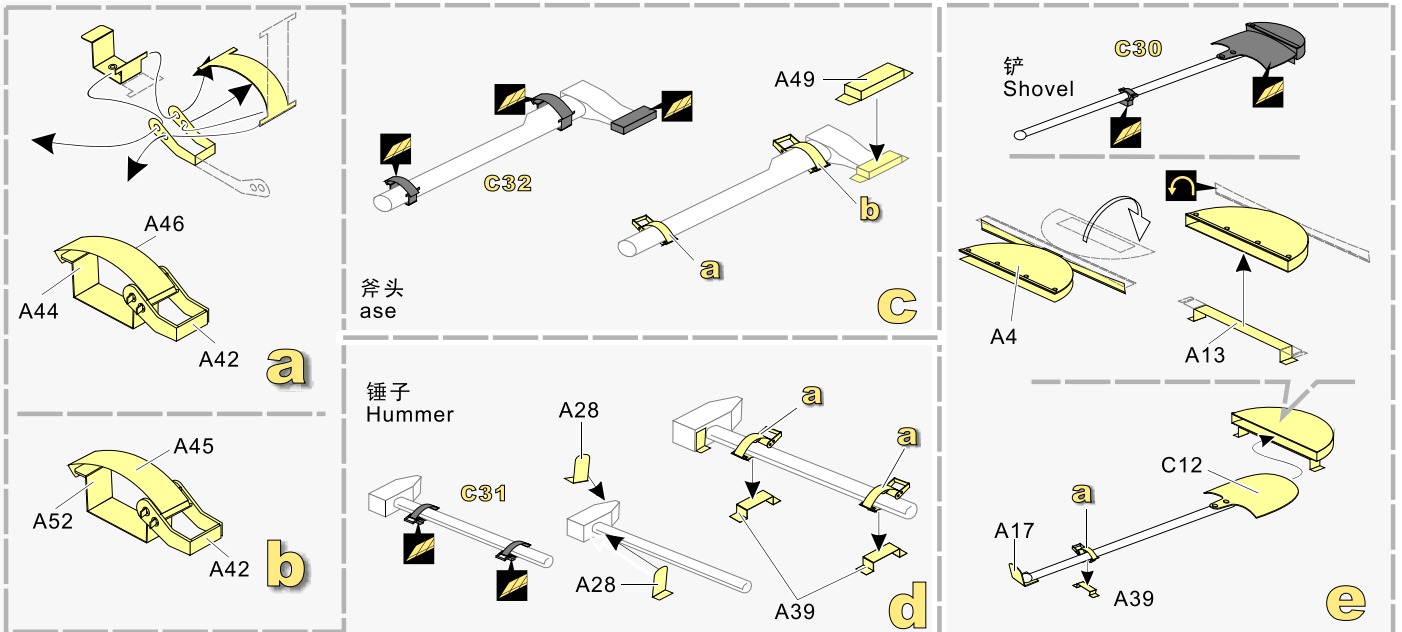
1/35 MILITARY MINIATURE VEHICLE UPGRADE SERIES PE35245

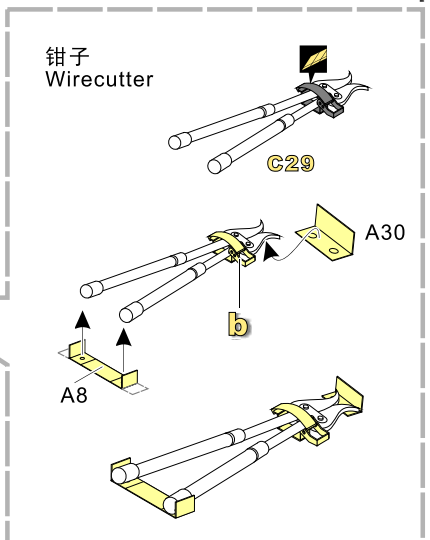
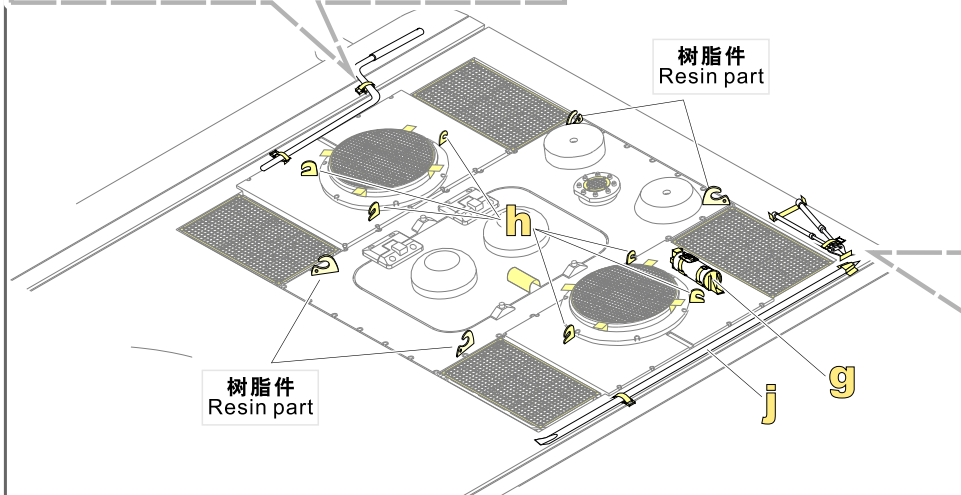
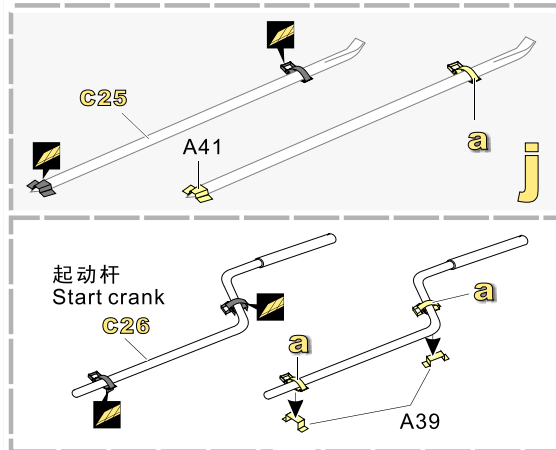
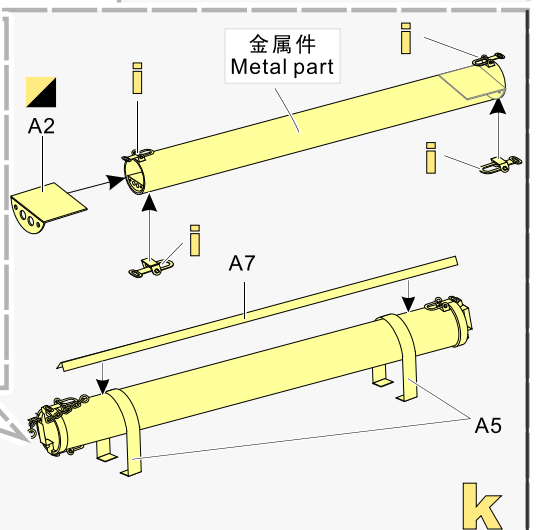
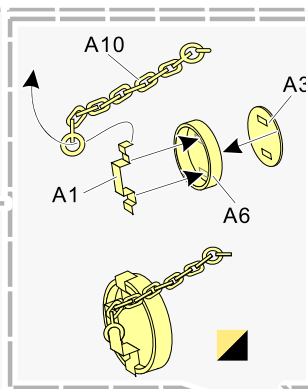
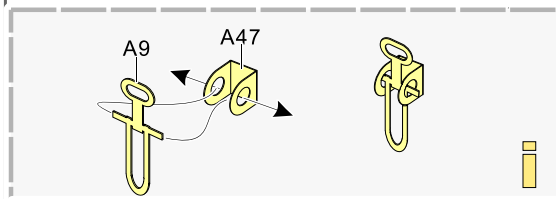
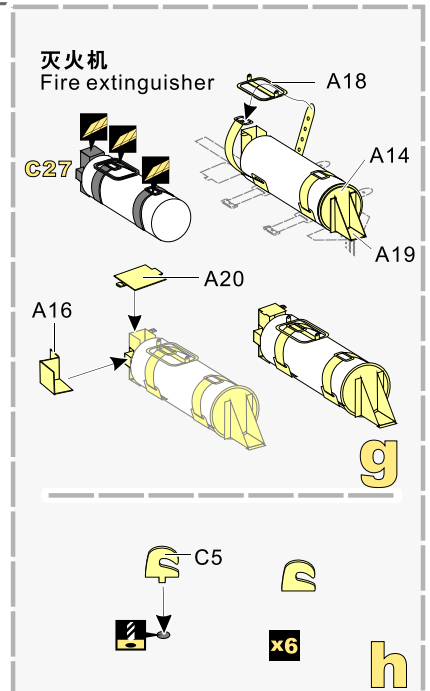
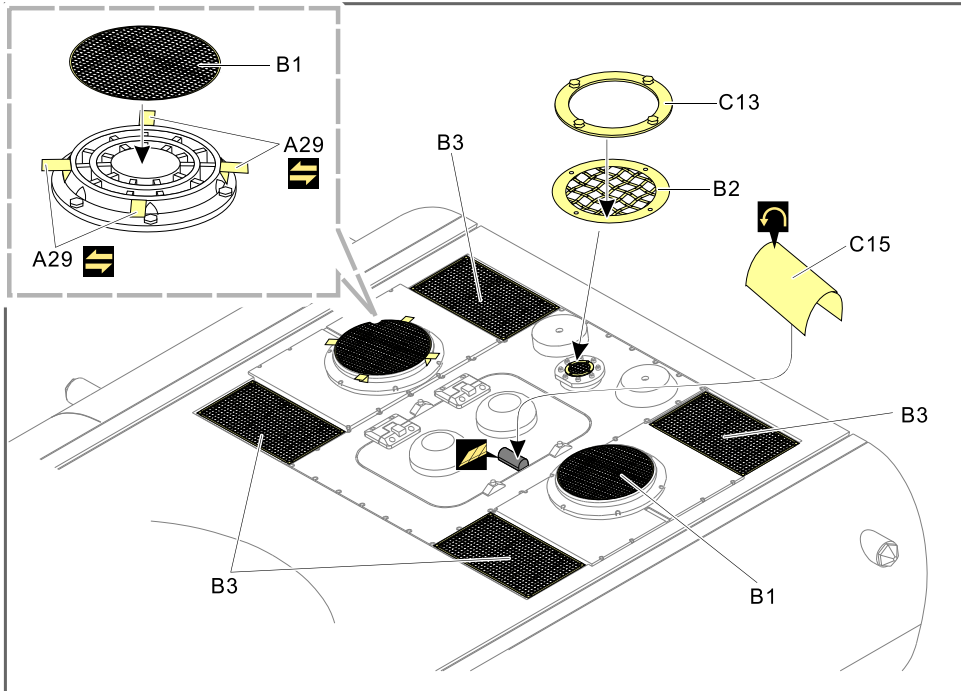

1/35 MILITARY MINIATURE VEHICLE UPGRADE SERIES PE35245

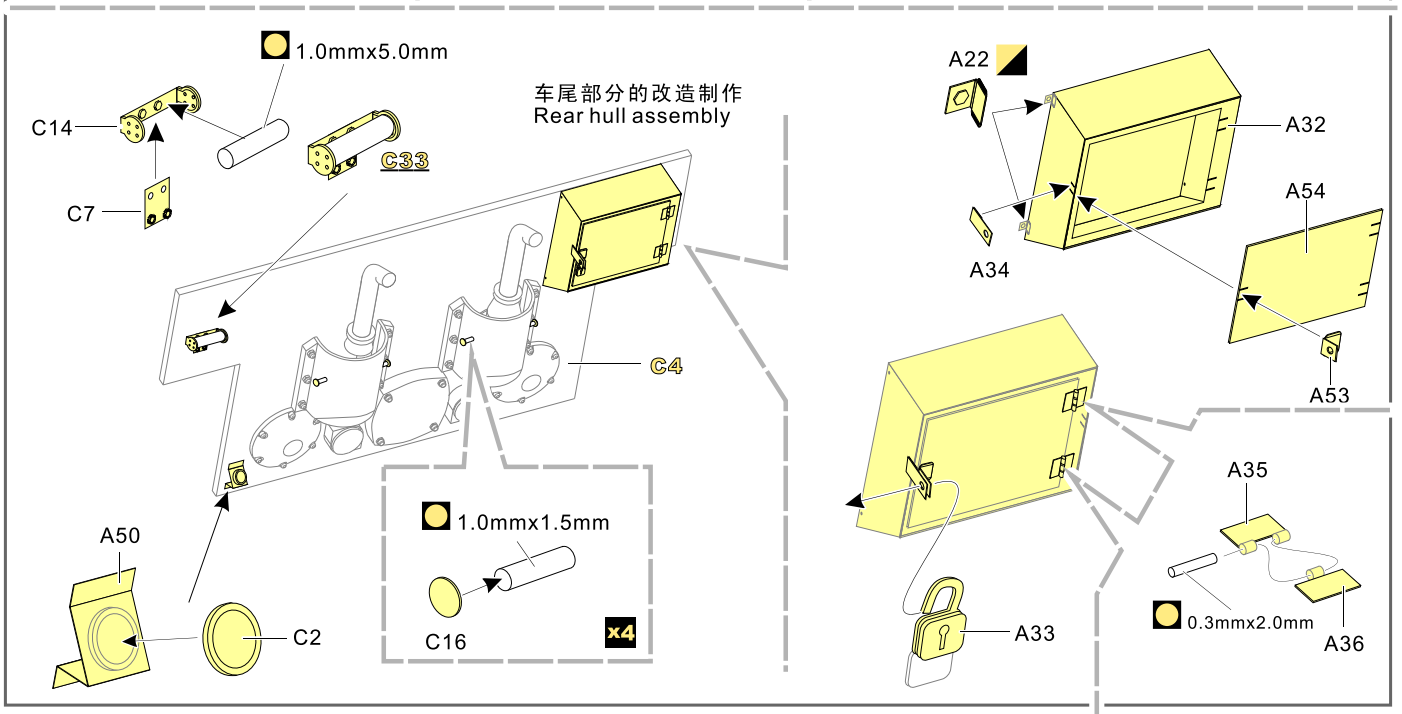
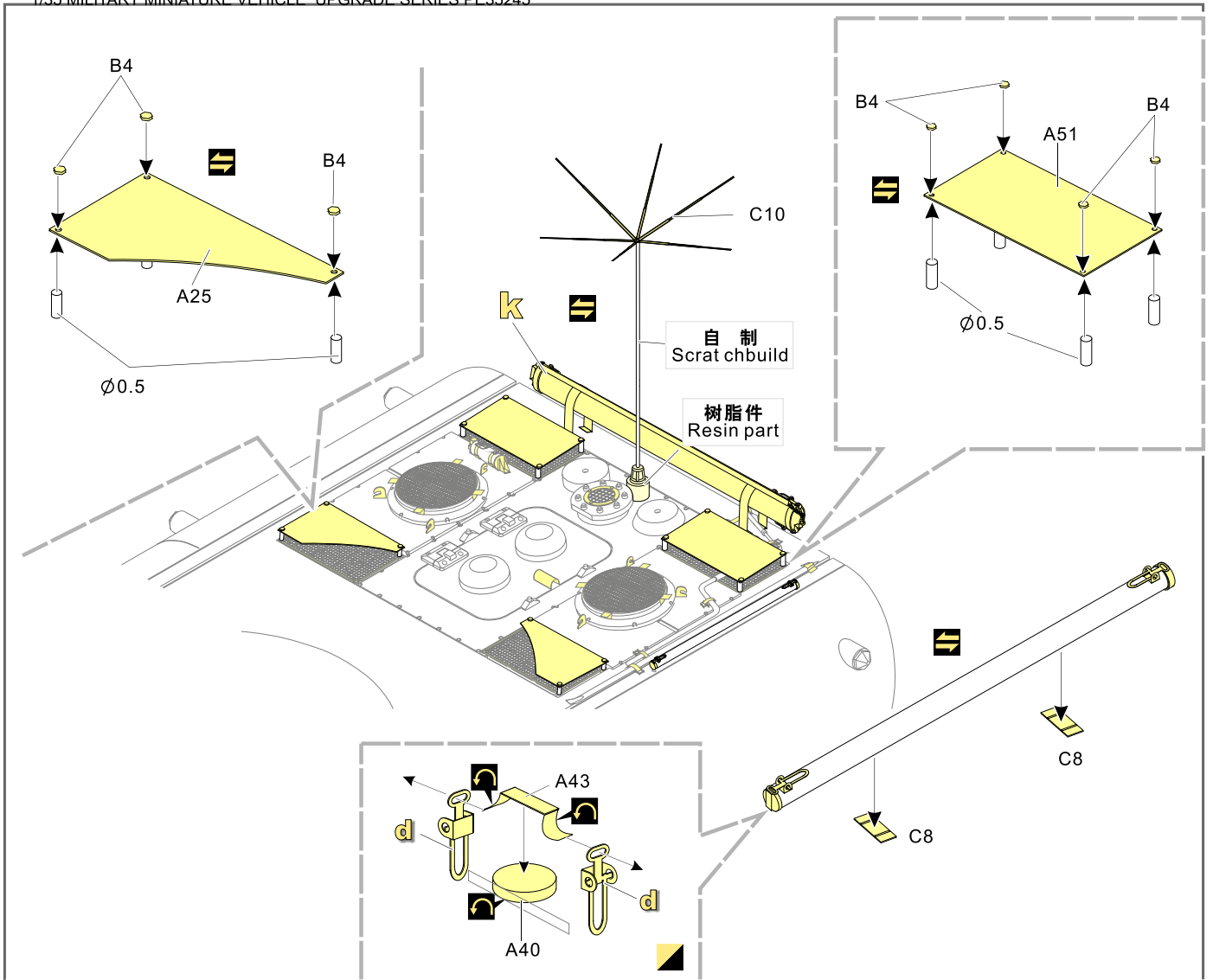

1/35 MILITARY MINIATURE VEHICLE UPGRADE SERIES PE35245

