

SMM3564L *Ferret Interior Set*

Intended for use with the Airfix Ferret Mk.2.

Ferret had a long service life spread over 5 decades. Finding in-service, in-period, interior photos is near impossible. The best illustrations are the stowage diagrams included here.



This set does not pretend to be authentic for any one period or mission, but I hope there are enough options to depict a No.19 (1950s/60s), Larkspur (to the late 70s) or Clansman Ferret. Optional crew switch gear is provided for each radio in this set. Hopefully, most eventualities are covered in this set.

The good thing about the *Airfix* kit is that they supply nice Larkspur and Clansman radios. No.19 wirelss and antennae are available as **SMM3566A** and **3566B**. Larkspur antennae mounts **SMM3565**. Clansman mounts **SMM3564R**.

The interior is only really visible in Ferret Mk.1. These were initially equipped with jump seats on the the inside of the escape hatches, shown here in the instructions, replaced in Mk.2 with MG ammo bins (and retrofitted to Mk.1 later).

This set shows three different interior options from the three periods mentioned above. Of course, there were many variations over time but, considering that relatively little will be seen – other than Mk.1 with it's open roof – there should be more than enough to satisfy the eye in this set.

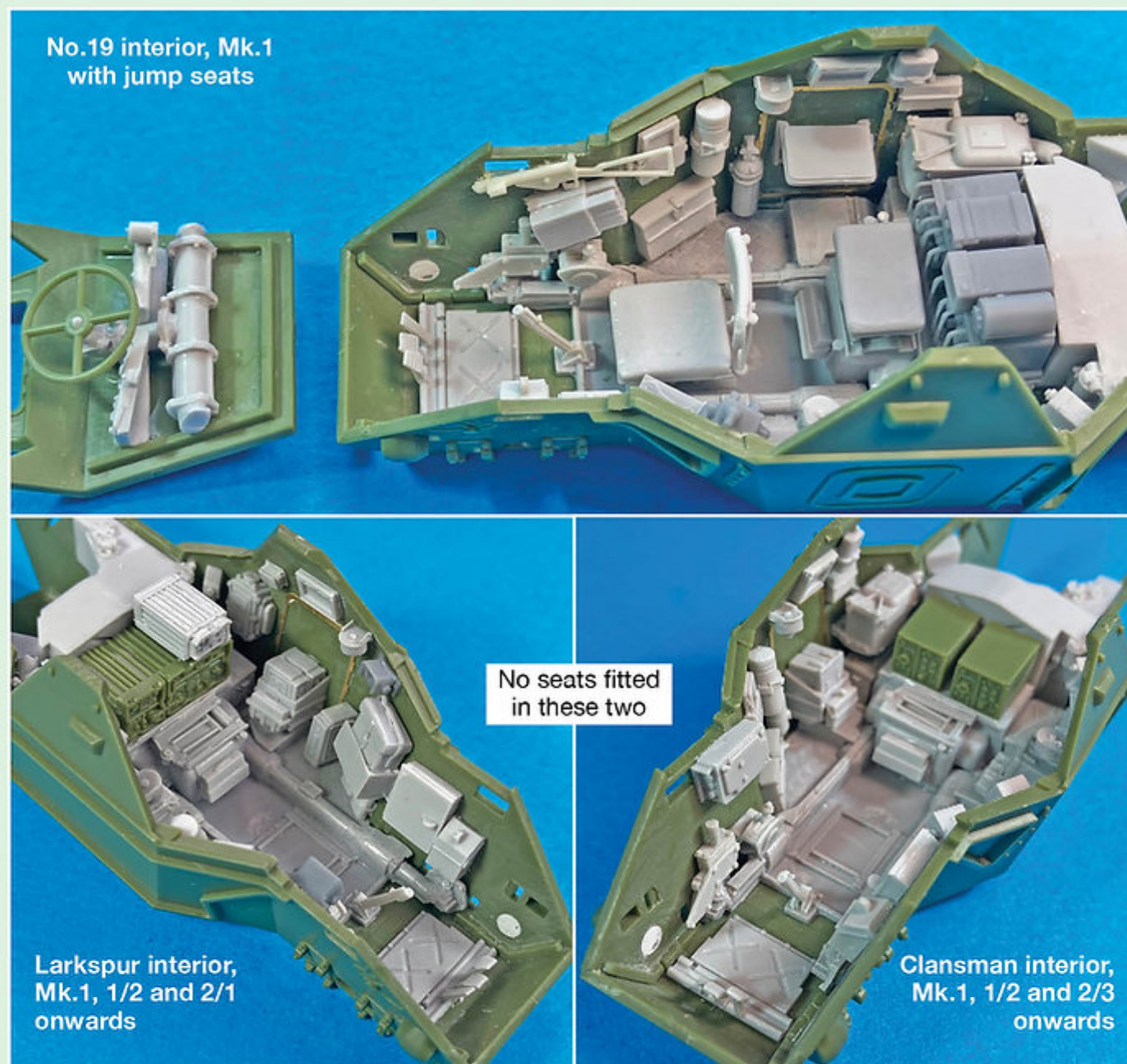

Parts List

- 1 Floor plate
- 2 Gearbox housing
- 3 Fuel tank
- 4 Air cleaner
- 5 Battery boxes (2)
- 6 Handbrake lever
- 7 Foot pedals
- 8 Drivers switch panel
- 9 Drivers instrument panel
- 10 Driver's footplate
- 11 Steering gear housing
- 12 TUAM box (driver's position)
- 13 Hydraulic oil reservoir
- 14 Gear change lever
- 15 Commander's seat
- 16 Commander's seat, base plate
- 17 Scissor frames, front/rear
- 18 Driver's seat, early pattern, back
- 19 Driver's seat, early pattern, base
- 20 Driver's seat, late pattern, back
- 21 Driver's seat, late pattern, base
- 22 Driver's seat frames (2)
- 23 Jump seat, raised (2)
- 24 Jump seat, lowered (2)
- 25 Side visor glasses (2)
- 26 Periscope stowage box, late
- 27 Periscope stowage box, early
- 28 Water bottles (double)
- 29 Water bottles (single)
- 30 Thermos flasks (x3)
- 31 Electrical outlet socket
- 32 No.2 Mk.1 Generator panel, Mk.1 Ferret
- 33 No.9 Mk.3 Generator panel, Mk.2 Ferret
- 34 No.88 Wireless
- 35 Larkspur B47
- 36 No.88 manpack (stowed)
- 37 Carbon-tetrachloride fire extinguisher
- 38 BCF fire extinguisher
- 39 Periscope storage locker
- 40 Periscope storage locker (alt)
- 41 Grenade stowage boxes (4)
- 42 First Aid box
- 43 Sten gun/SMG ammo clips stowage (2)
- 44 MG Toolbox
- 45 Vehicle document case
- 46 First-Aid-box
- 47 Bren gun ammo small
- 48 Bren gun ammo large
- 49 Loose early .30 cal box
- 52 Early pattern .30 cal ammo box stowage internal (2)
- 53 GPMG ammo internal (2)
- 54 Clansman switch-box
- 55 Clansman intercom
- 56 Clansman driver crew box DB (2)
- 57 Clansman commander crew box CB2
- 58 Clansman interconnecting box IB3
- 59 Interior lights (2)
- 60 Larkspur radio junction box C (3)
- 61 Larkspur crew junction box R
- 62 Larkspur junction box J1
- 63 Smoke firing button
- 64 No.10 switches (3)

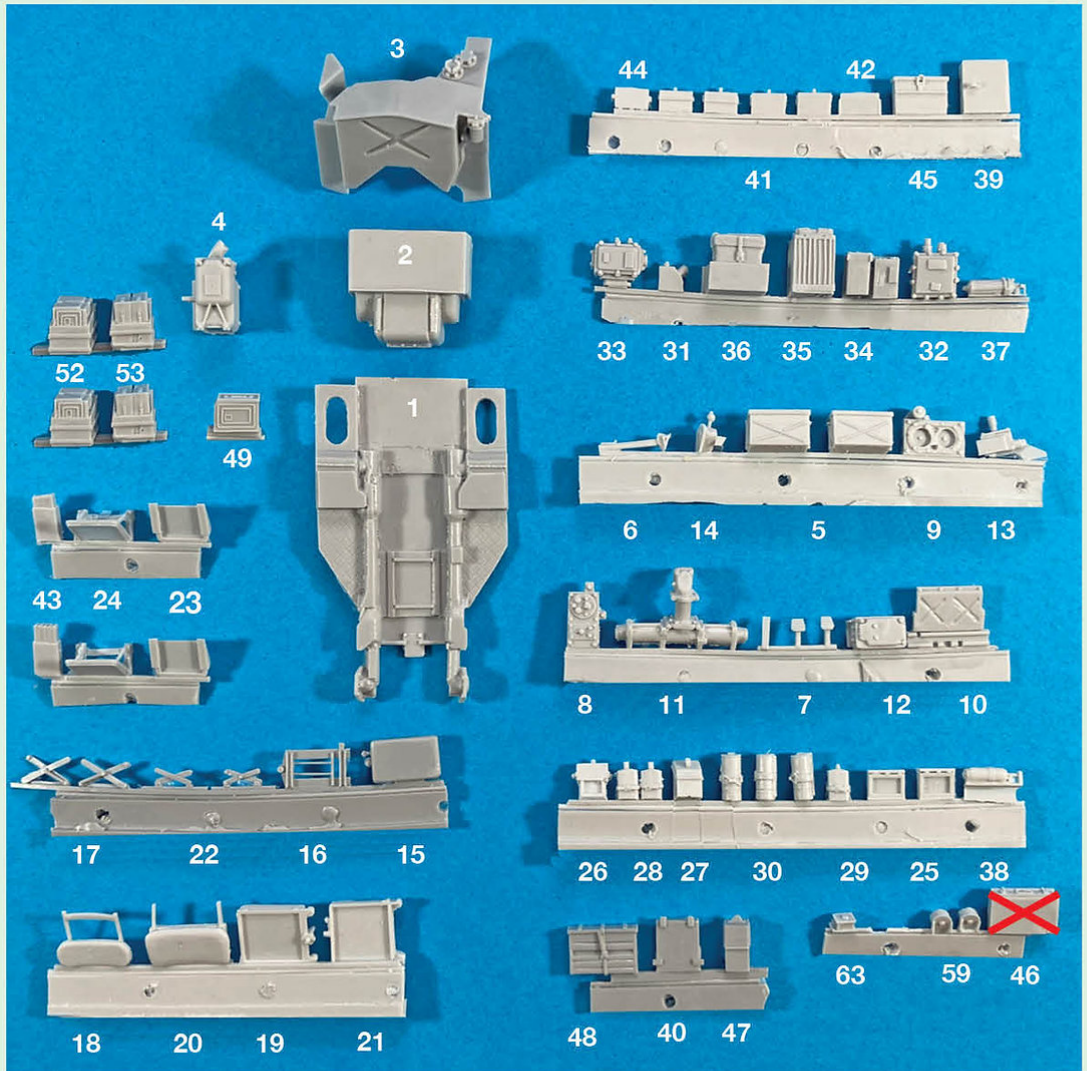
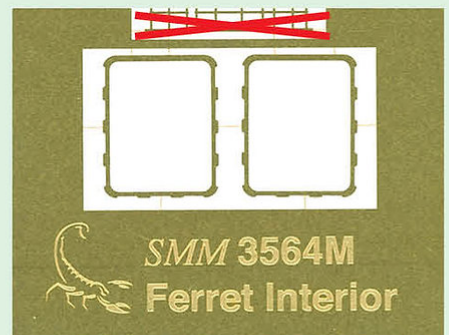

Photo-etch

- A** No.19 Wireless guard
B Escape hatch welds (2)



Switches



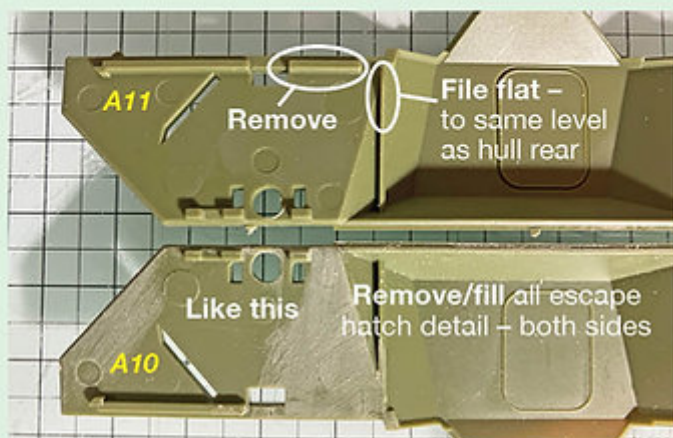

Airfix parts marked in **yellow**

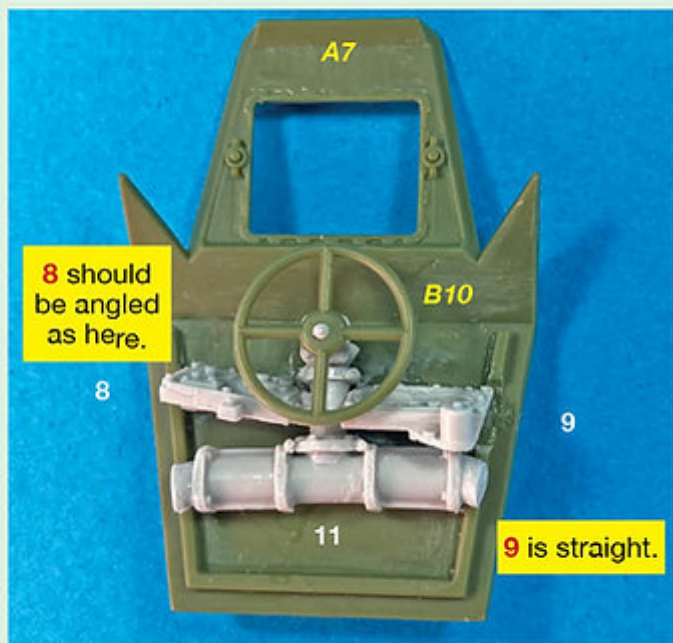

Outer edges of parts **8**, **9** and **11** will have to be bevelled slightly to fit inside your hull. Be careful **NOT** to take the outer sides off the two panels. **DO NOT** attach this until the interior is complete. You will need this assembly to make sure parts do not interfere with each other inside the hull sides.

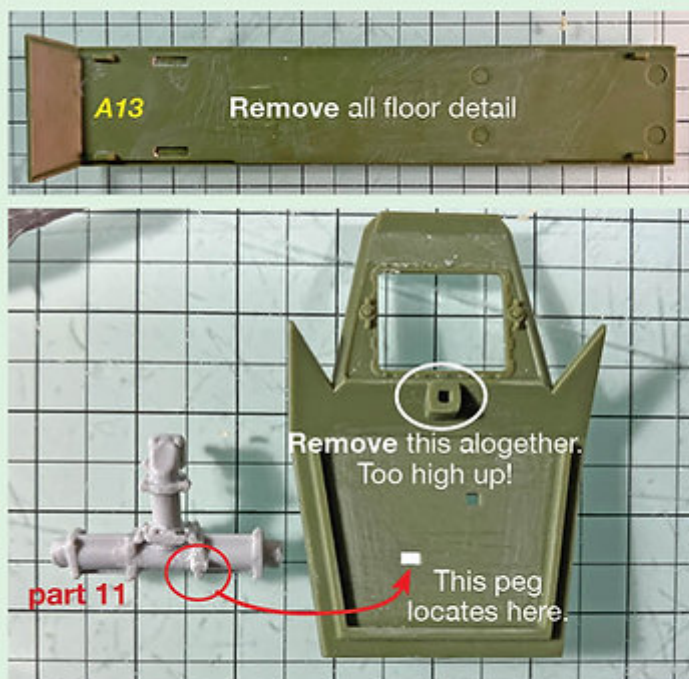

Some warping may be evident, so use hot water or a hair drier to straighten parts as necessary. **Do not bend without heating.**

Damage may occur on parts with thicker casting tabs. When removing the casting tabs, cut them off instead of snapping them off.

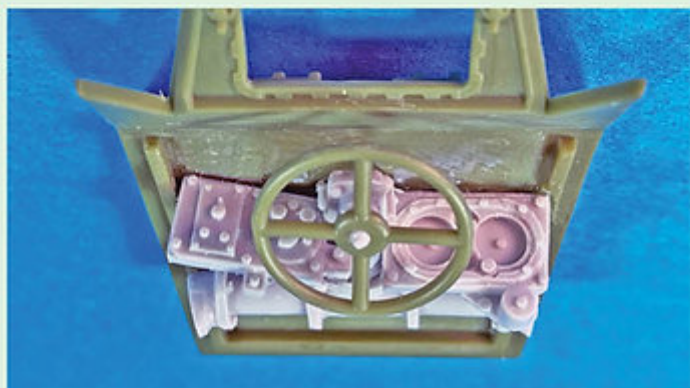

Common base for all versions

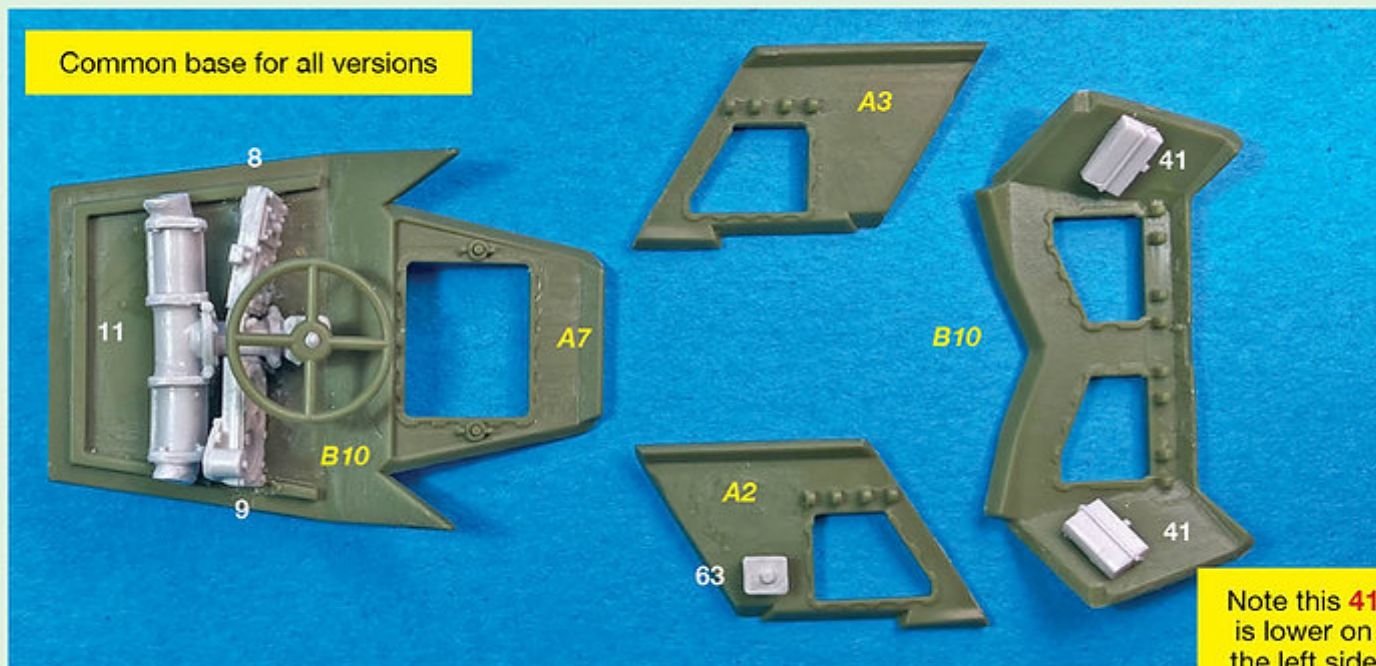

Note this **41** is lower on the left side

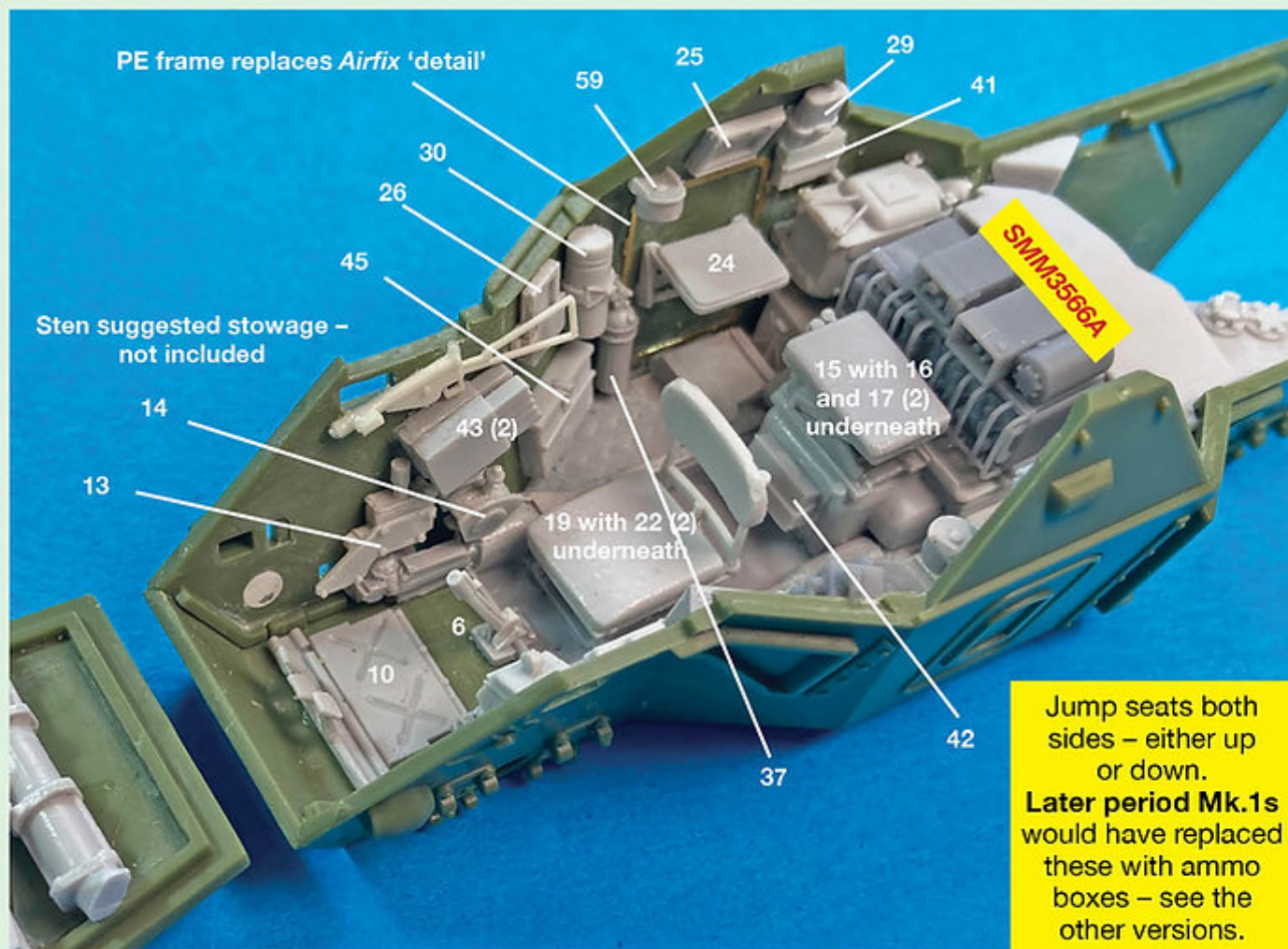
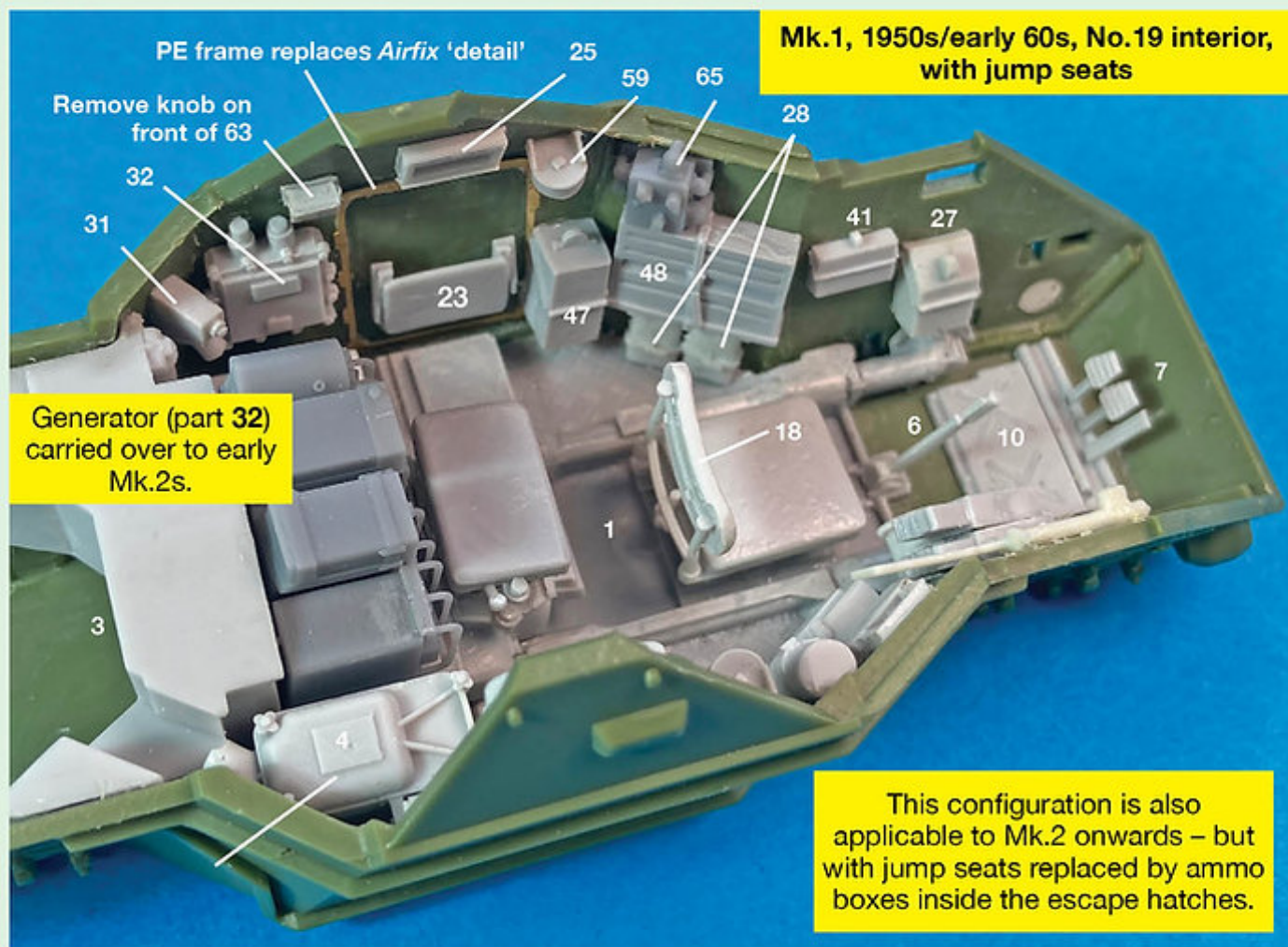

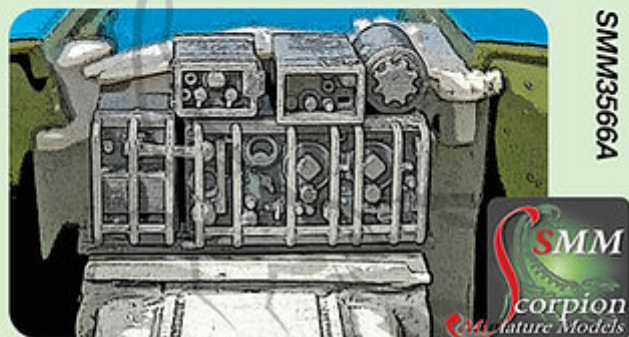
Recommended!**No.19 Wireless Set**

SMM3566A

No.19 Wireless Antennae Set

SMM3566B

Air cleaner (part 4) is bracketed to the wall. Do not sit it on top of the battery. Leave a gap.

4

No.19

Commander's seat can be lowered by omitting parts 17 (x2). Leave part 16 in place (see pages 6/7 for placement).

5

Batteries (2) either side of the gearbox housing (part 2)

Colours

Overall inner turret	aluminium
Equipment boxes	aluminium
Sights/radio	gloss bronze green
Intercom panels	light grey

There are conflicting views regarding interior upholstery colour, with no exact consensus of what changed when. The commander's seat in front of the radio was burgundy. The green pads either side on top of the drive shafts were green. The driver's seat was green heavy canvas – both back rest and base. The eyebrow pads for the front and side hatch episcopes were either black or green, some may have been burgundy leather.

Early 60s to the late 70s,
Larkspur interior, Mk.1,
1/2 and 2/1 onwards

18/19 with 22 (2)
underneath



15 with 17 (2)
underneath



Seats shown removed for further
clarity below.

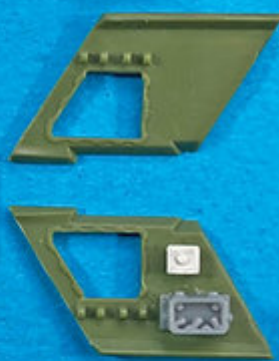
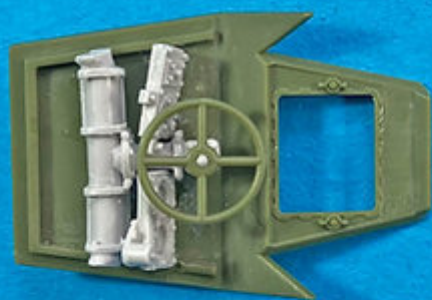

Sten suggested
storage – not included



Gun is fitted horizontally
under hull roof

Larkspur

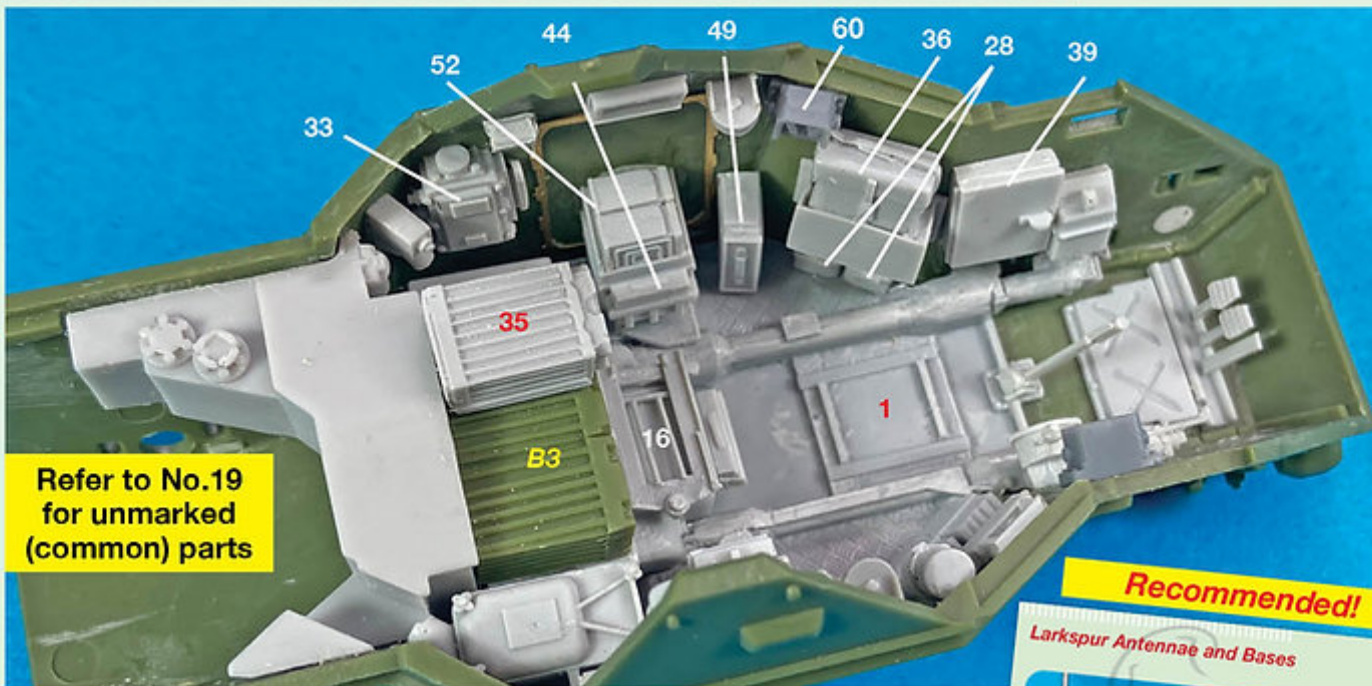

Recommended!

Larkspur Antennae and Bases

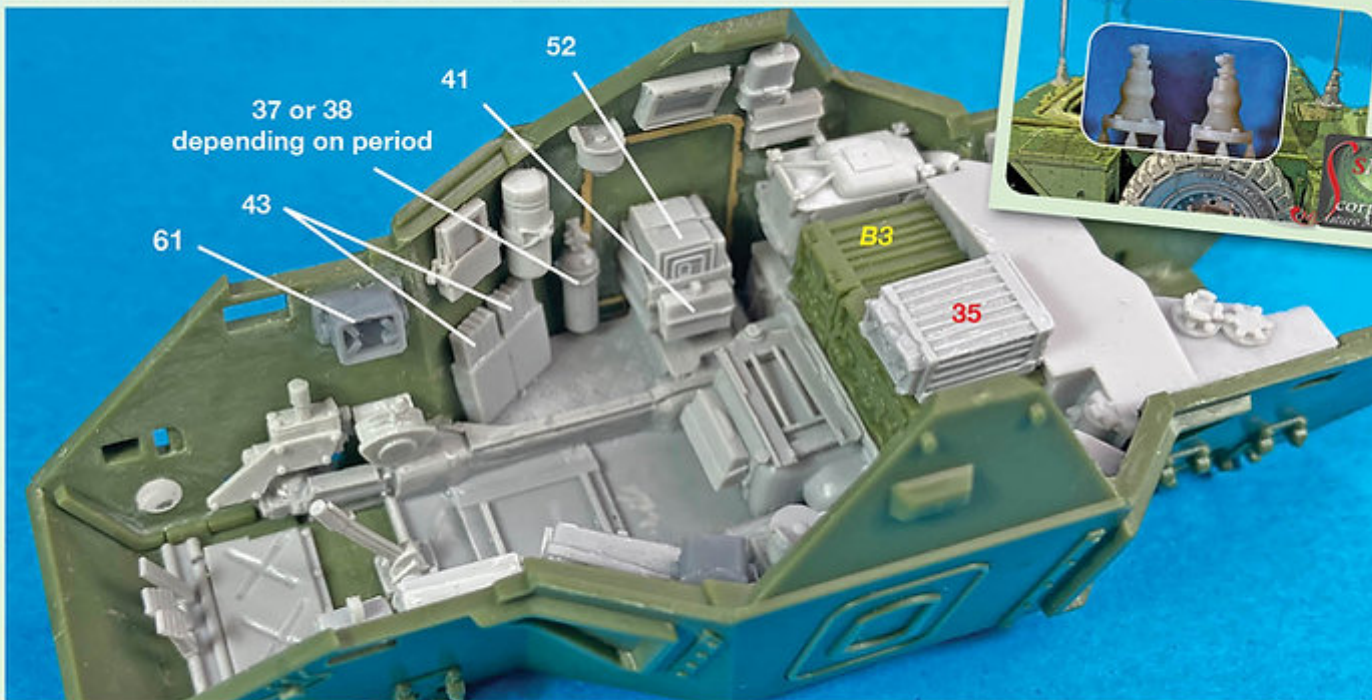

Late 70s to retirement,
Clansman interior, Mk.1,
1/2 and 2/3 onwards

Seats shown
removed for further
clarity below.

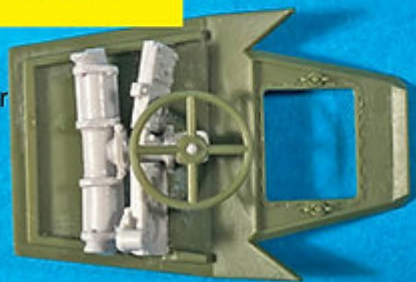

18/19 with 22 (2)
underneath



15 with 17 (2)
underneath



56



58



Later, larger seat (optional)



20/21 with 22 (2)
underneath

Refer to Larkspur
for unmarked
(common) parts

53 with 41

38

B21
(x2)

16

1

Clansman

Recommended!

Clansman Antennae and Bases for Ferret
3D-printing and turned brass

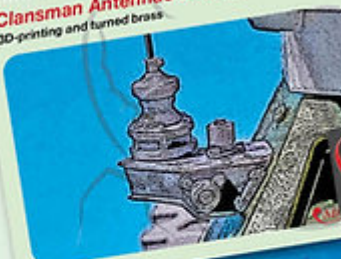

SMM3564R

SMM
corption
since 2002

53 with 44

56

57

30

B21
(x2)

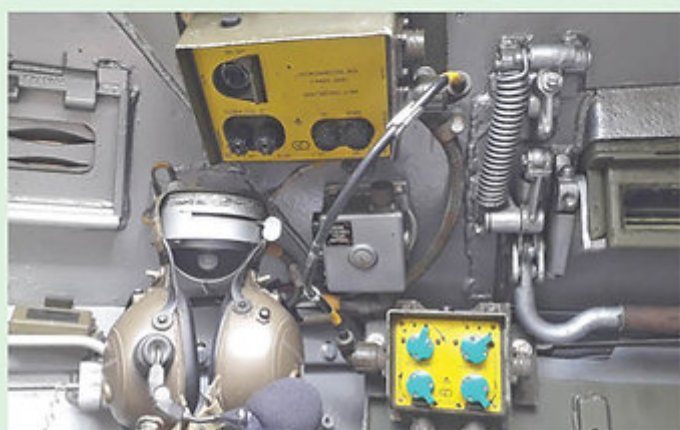
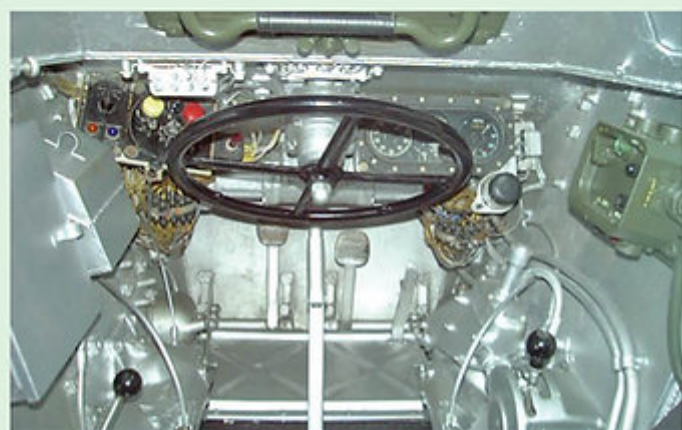

Photos from Brightwells Auction and various unattributed internet sources

A gallery of reference photographs can be found on the SMM website:

Happy modelling and keep on building!

Master parts built by Andrew Crutchley CAD design by Tom Cromwell

© SMM 2024 <http://www.scorpion-miniature-models.co.uk> Cast by LZ Models Photo-etch by PPD Ltd

