

# STRYKER, LAV-III Wheel Set-Sagged

8X8 ICV

For AFV CLUB, TRUMPETER KIT

**D.E.E. MODEL**

DETAILER DETAIL MODEL CAR'S ETC.

DW 350110

## Part List

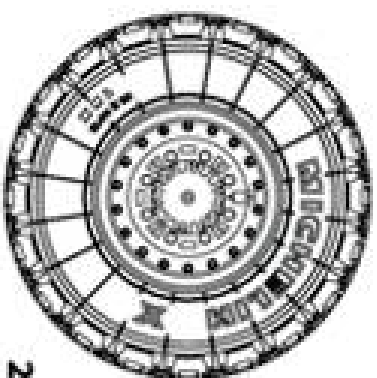
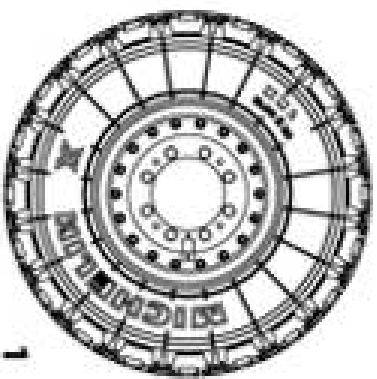

(A,B,C,D)

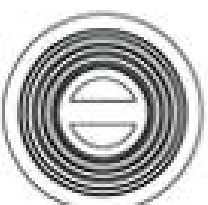

3

1. Spare Tire x 1
2. Sagged Tire A x 2  
Sagged Tire B x 2  
Sagged Tire C x 2  
Sagged Tire D x 2
3. Connector  
For Trumpeter Kit x 8  
With Easy Mask Seal

## Assembly

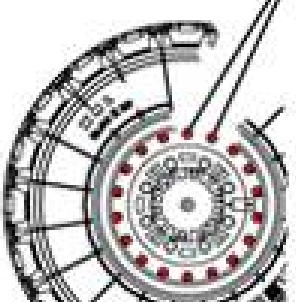
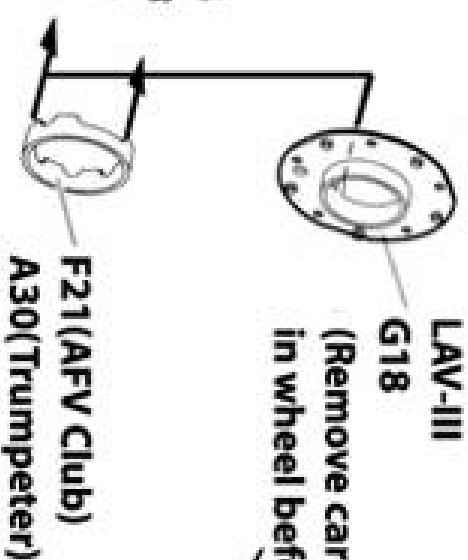
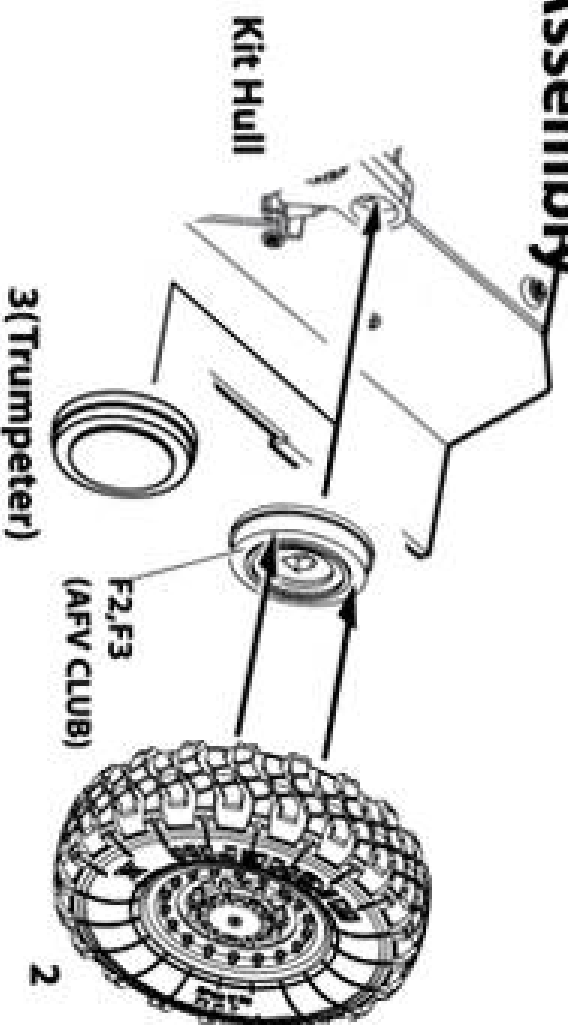

(Remove carved bolt  
in wheel before combine)

Already cut to fit the your wheels

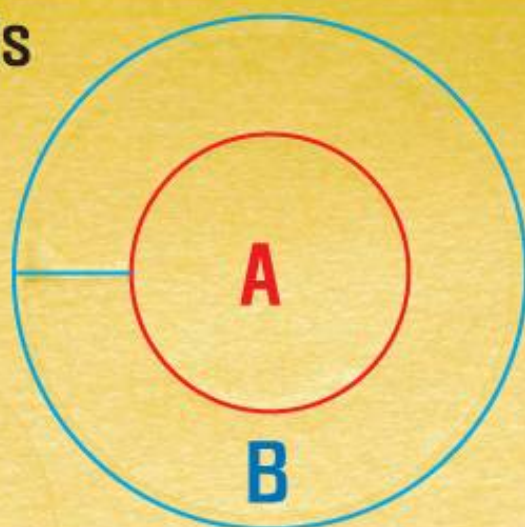

Use **A**

Use **B**



Paint the wheel, first

Paint the tire, first



Mask the wheel area using "**A**"  
and then, paint the tire

Mask the tire area using "**B**"  
Then, paint the wheel



Done!



Done!