

1:72 SCALE

German Ju88



EASY ASSEMBLY AUTHENTIC KIT



cianoacrylate glue
强力胶



weight
配重



make hole
钻孔



cut / remove
切除



option
选择



no cement
不涂胶水



decal
贴纸



bend
弯曲

The way to apply the decals

1. Cut off the decal from the decal paper and put it into the warm water 40 °C for 10 seconds.
2. Take the decal from the water and put it on a piece of clean cloth.
3. Remove the decal slowly from the paper to the targeted location by a wet finger.
4. Use a piece of dry and soft cloth to press it gently on the decal until it getting dry and no bubble existing.

水贴纸的使用方法:

- 一. 把相关的印花从水贴上剪下, 放入40°C左右的温水中浸10秒.
- 二. 然后将印花放在干净的布上.
- 三. 拿上印花纸, 手指蘸水将印花移到适当的位置.
- 四. 用软干布轻压印花直至水干, 气泡消失.

80297

部品图 Parts

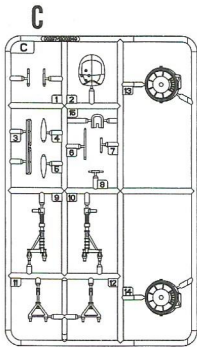
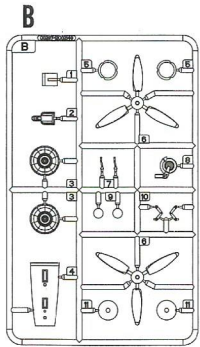

《水贴》
Decal

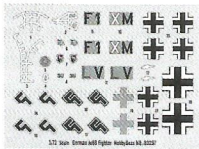

《下部机身》
Lower fuselage

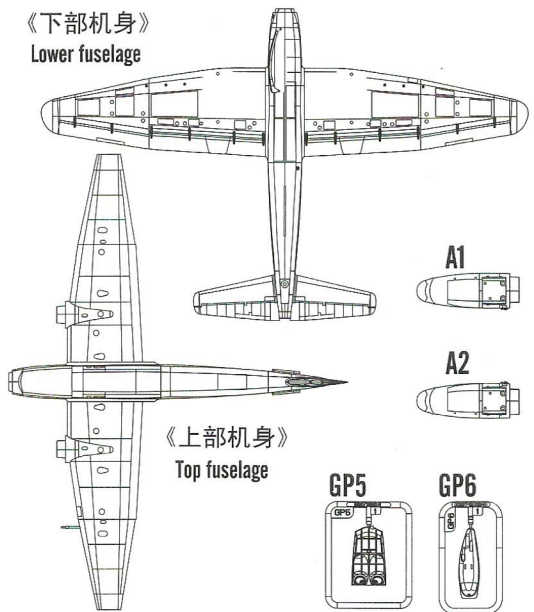

《上部机身》
Top fuselage

GP5



GP6

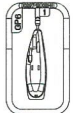

1
STEP

《上部机身》
Top fuselage

《下部机身》
Lower fuselage

H 70 60

德国灰
RLM02 Gray

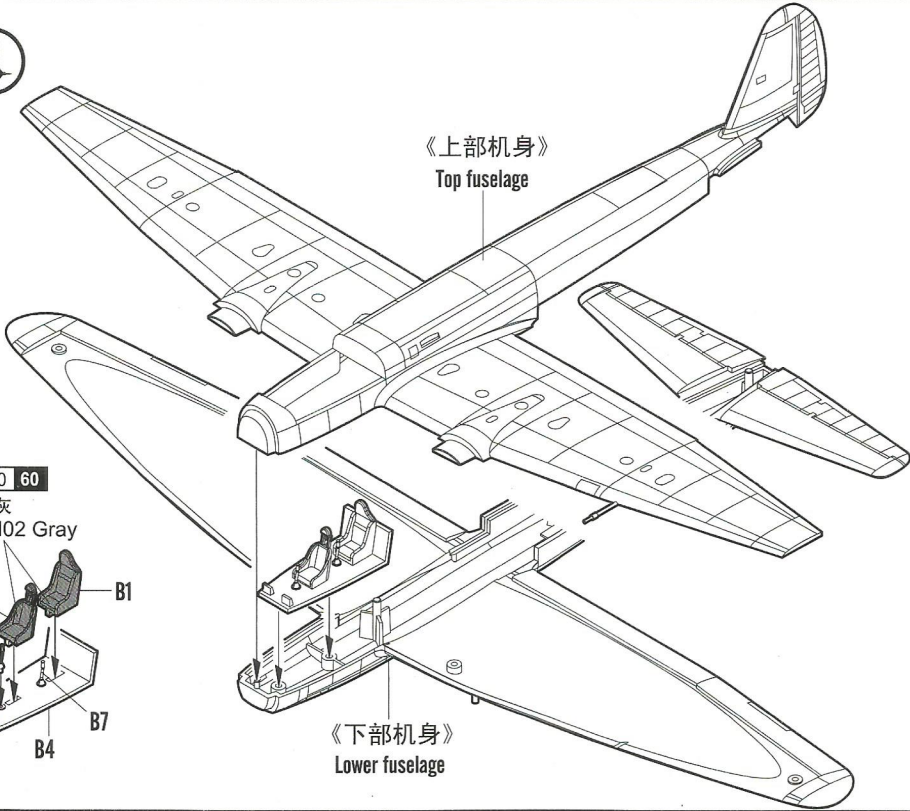
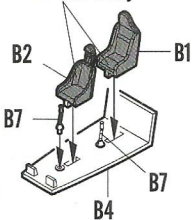

2
STEP

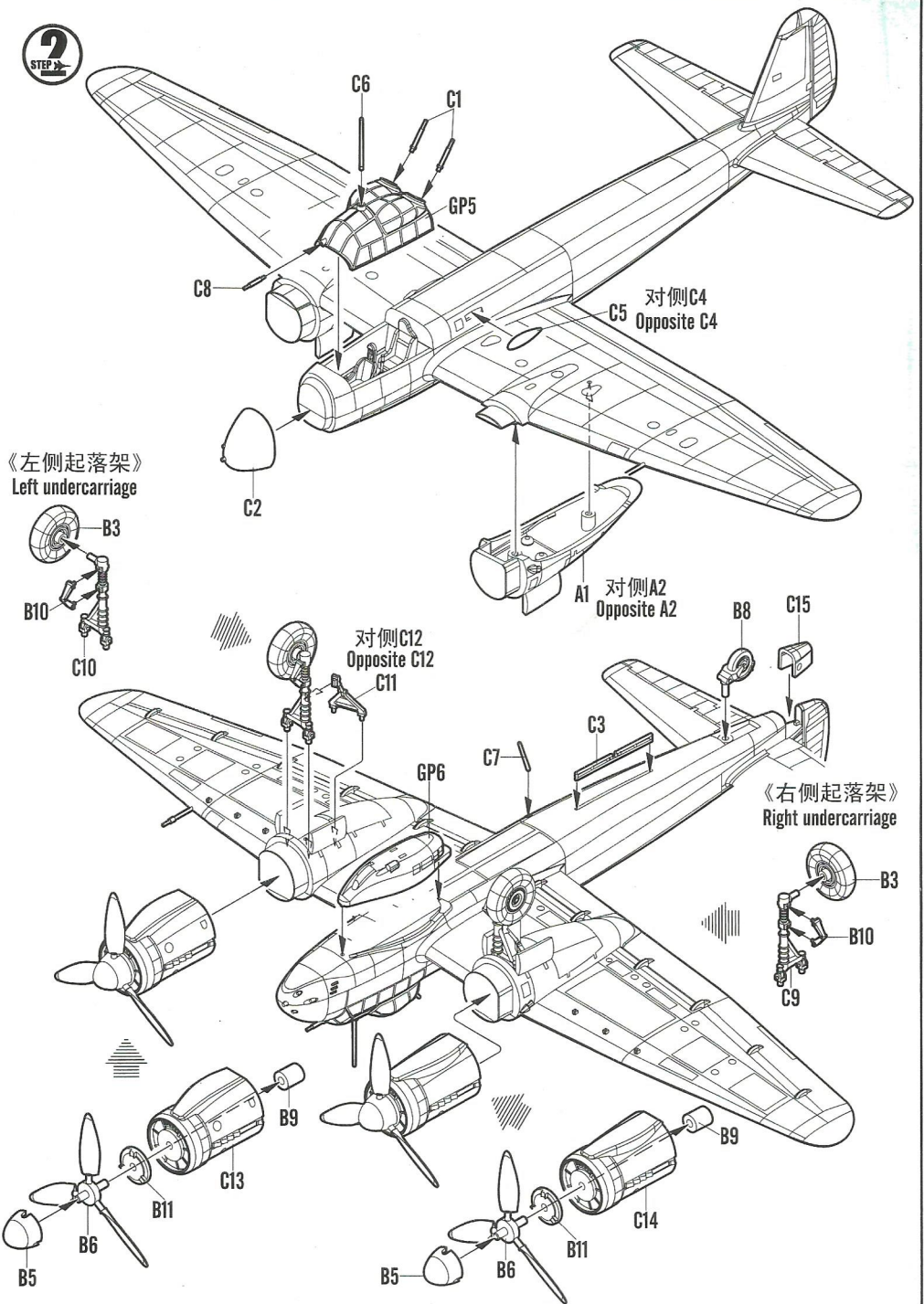

80297

A Germany J1 / Z6 26, Ju 88C-6, 3U + LV

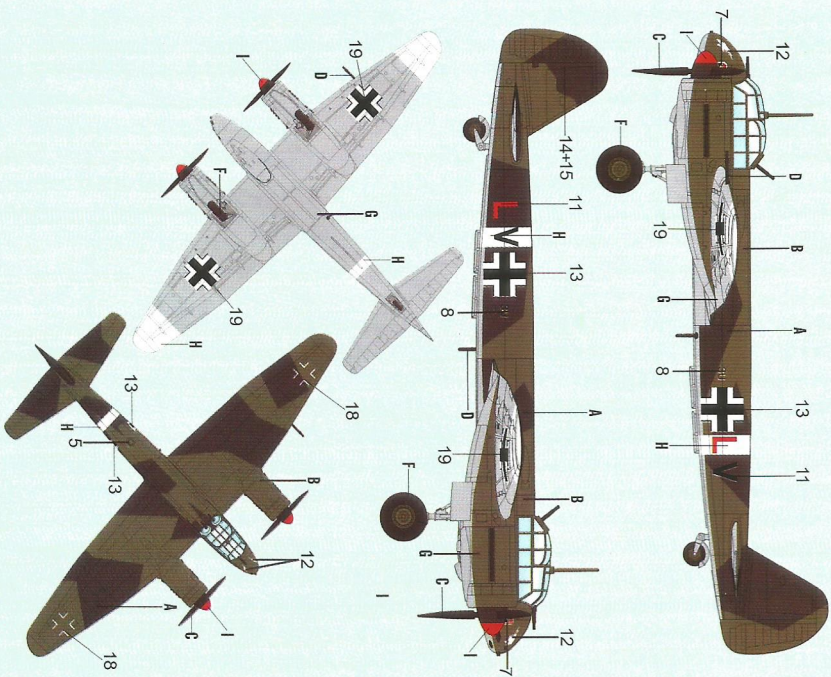

Color	Material	Value	Model Number	Tempa	Humid
A 墨绿色 Olive drab Green	H-16313	897	...	X27	91
B 暗绿色 Olive drab Green	H-16314
C 深光黑 Flat black	H-17233	950	...	T49	X7
D 深绿色 Steel	H-18323	864	...	102	...

B Germany A(2) / Z6 76, Ju 88C-6, F + XM

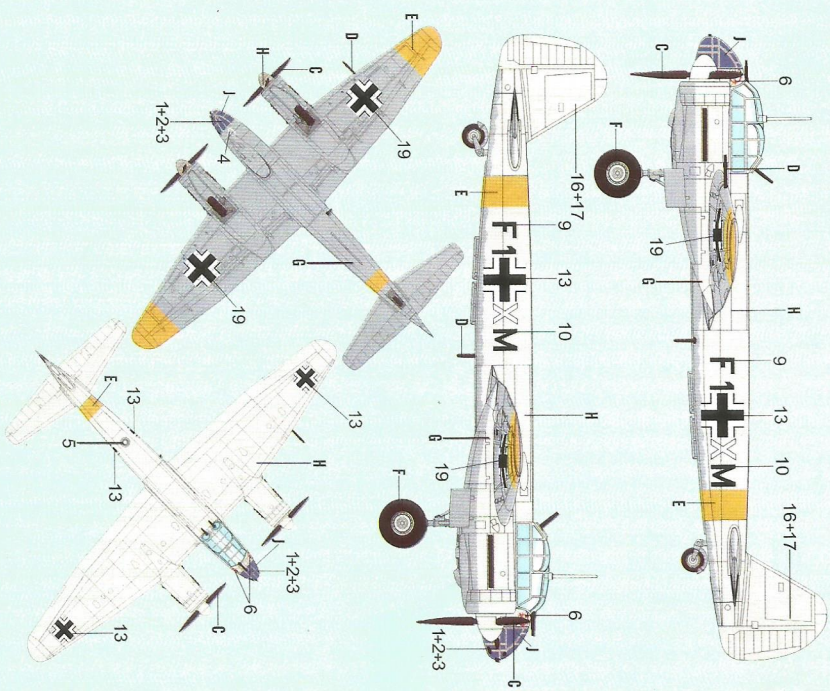

Color	Material	Value	Model Number	Tempa	Humid
E 黄色 Olive Yellow	H-113	A8	...
F 棕色 Olive Brown	H-17232	X23	65
G 亮蓝色 Light blue	H-107115	906	...	T40	X54
H 白色 White	H-16312	991	...	X54	140

Color	Material	Value	Model Number	Tempa	Humid
I 红色 Red	H-33	908	...	X7	19
J 灰蓝色 Intermediate Gray	H-15212	903	144