

■全体図

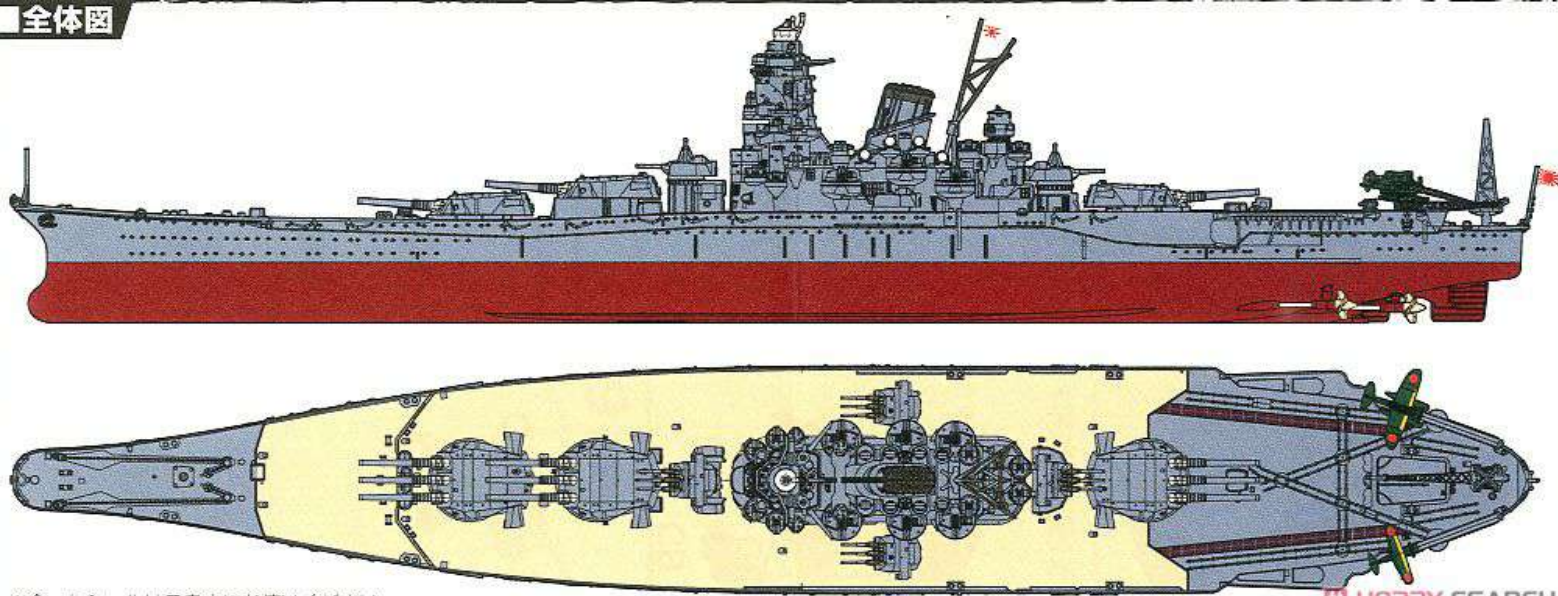

※余ったシールはご自由にお使いください。

HOBBY SEARCH

■キット内容

※キット内容を必ずお確かめください。万一、欠品や不良等ございましたら当社までご連絡ください。

艦底 部品



A 部品

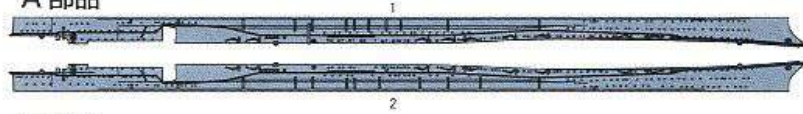

C 部品

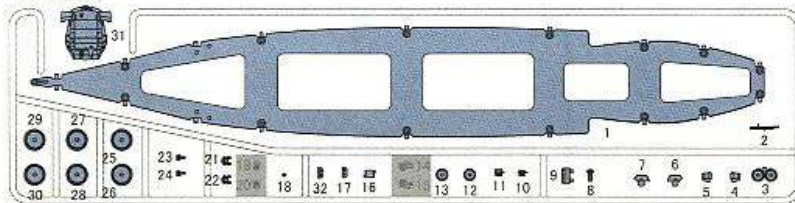

D 部品

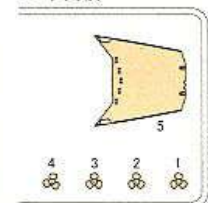

YK 部品

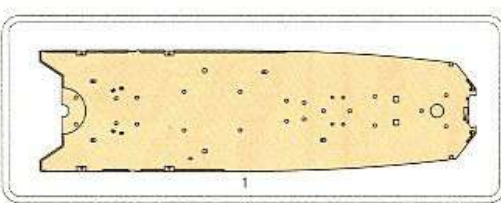

K 部品 (×2)



E 部品

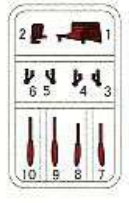

N 部品 (×2)

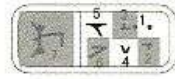

YH 部品 (×2)

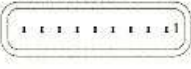

V 部品

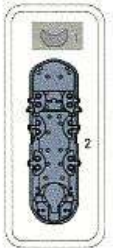

T 部品

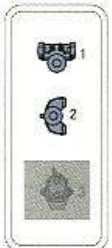

台座 部品 (34 黒画)

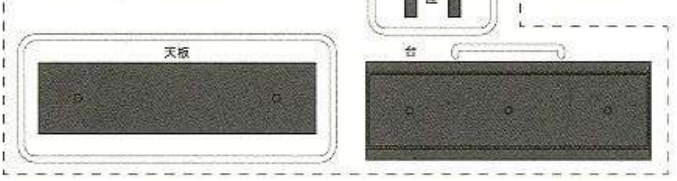

F 部品



R 部品

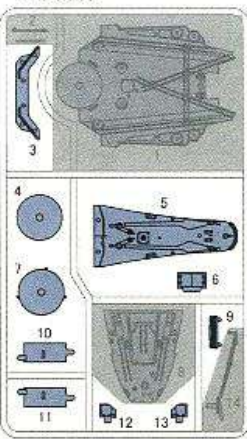

H 部品

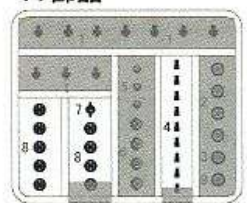

J 部品 (×3)



YE 部品

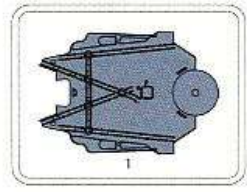

YA 部品

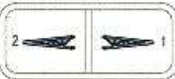

YB 部品

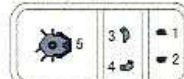

S 部品

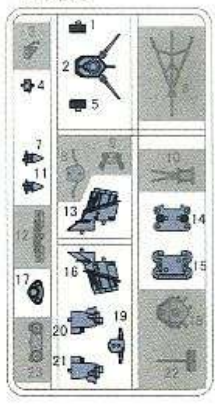

M 部品

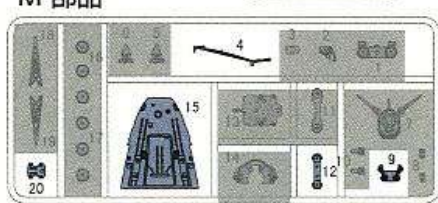

Z 部品 (×2)

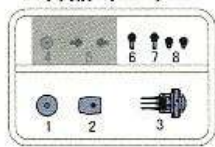

P 部品

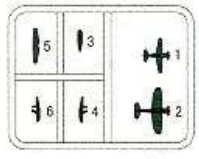

YD 部品

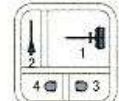

YF 部品

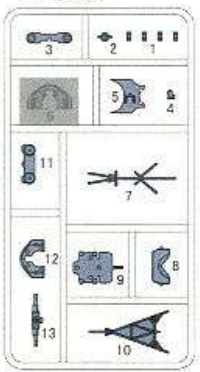

ピンセット



G 部品



X 主砲 部品 (×2)



X 部品



リアルシール

YJ 部品



HOBBY SEARCH 不要部品

1 (艦体)

★ニッパーは、刃の裏面が平らなものをご使用ください。

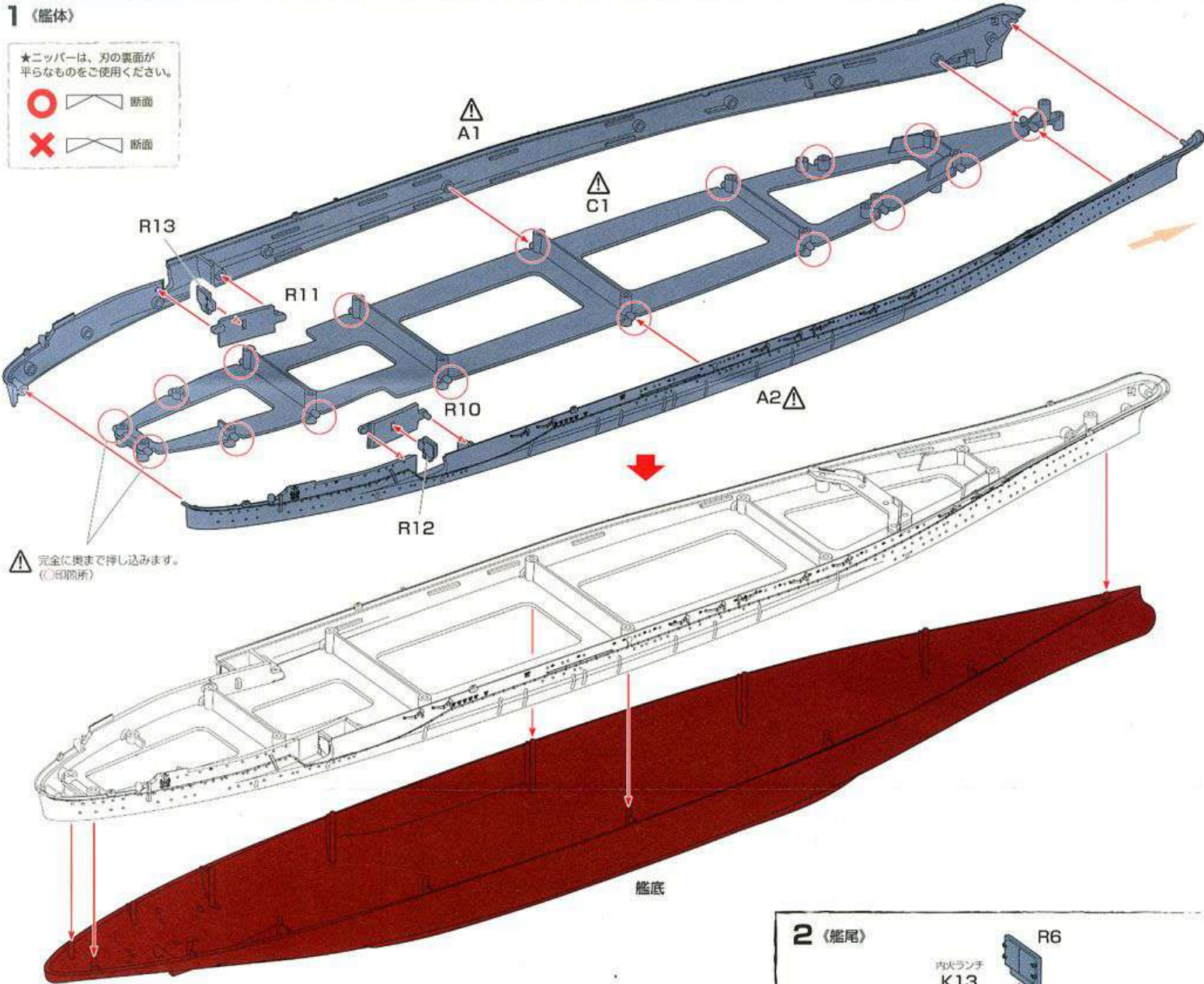
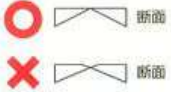

3 (艦尾底面)

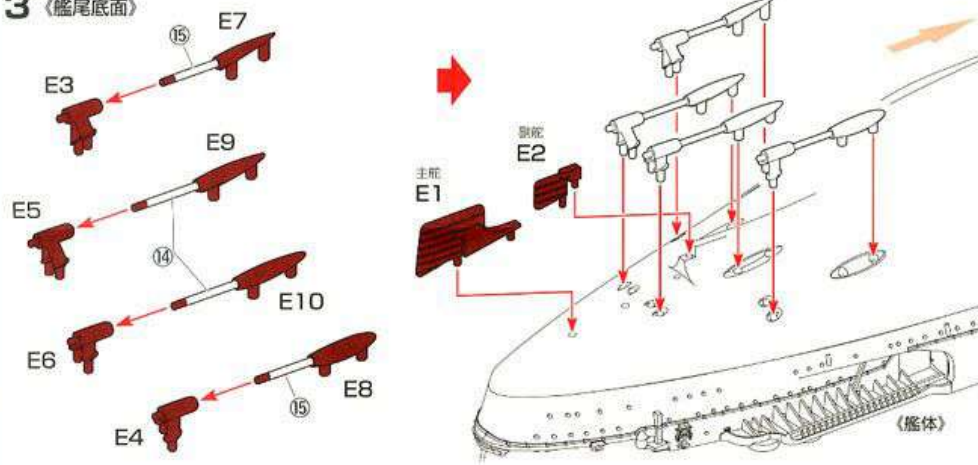

2 (艦尾)

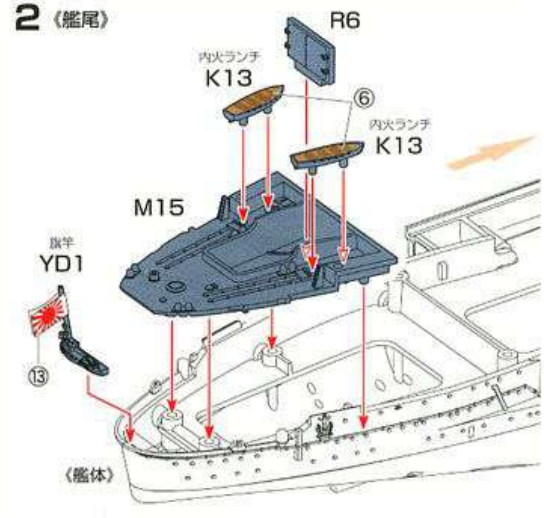

4 (甲板)

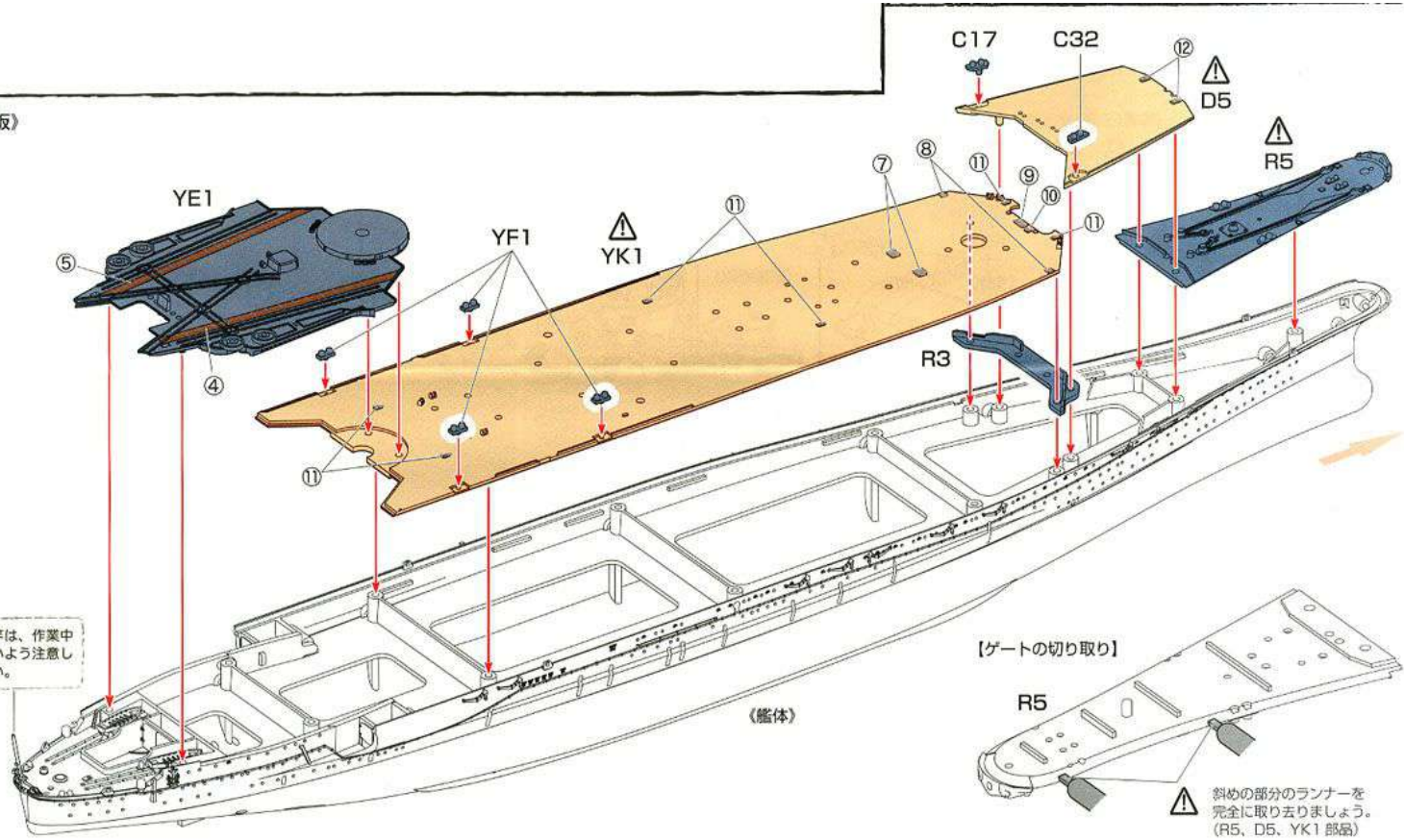

5 (艦橋基部)

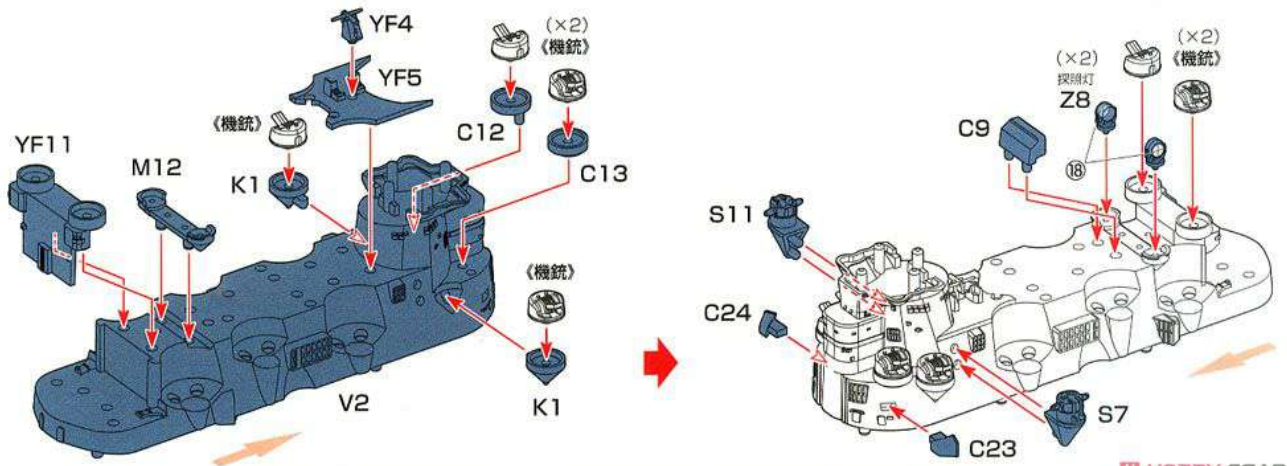

6

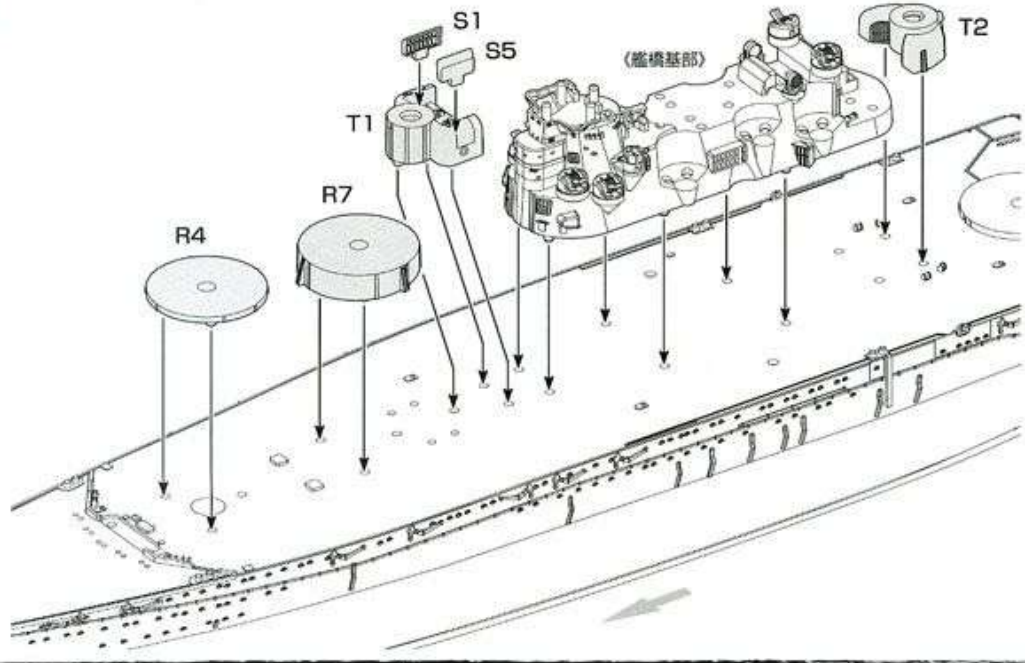

7 《副砲・機銃》

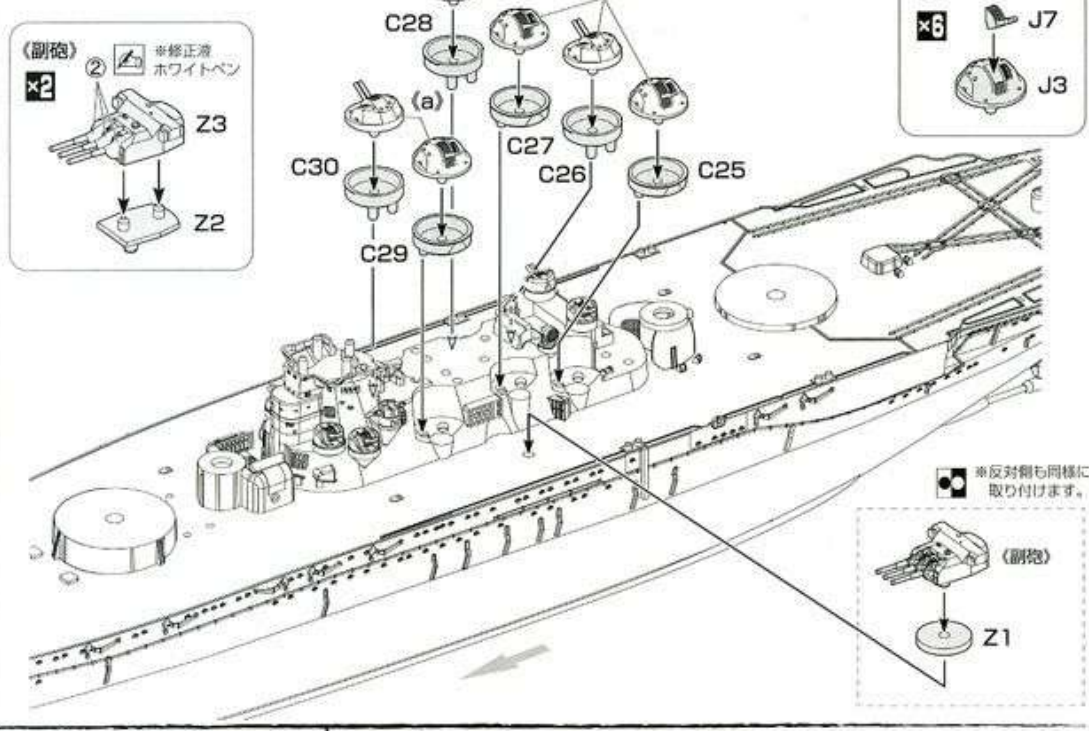

10 《後部艦橋》



11 《煙突》

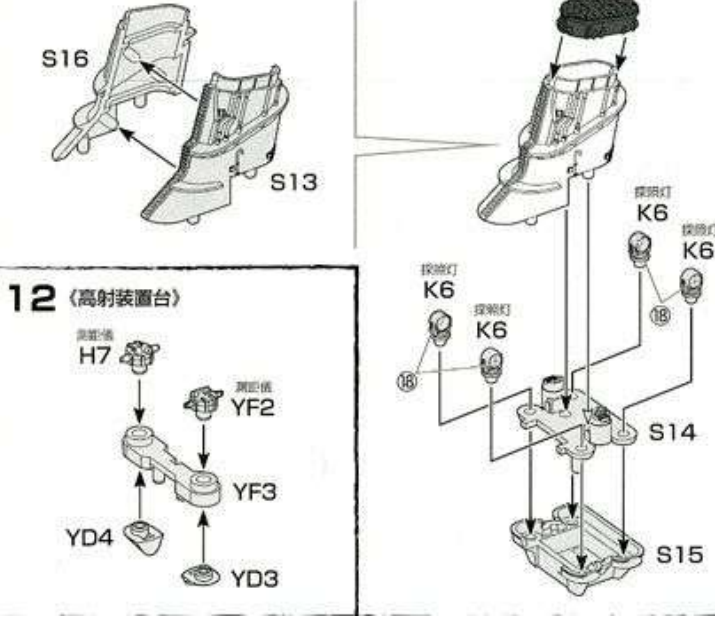

12 《高射装置台》

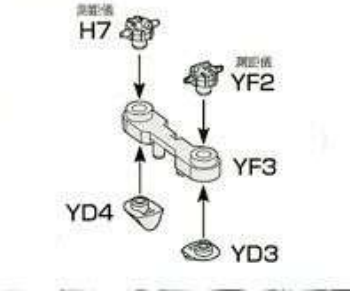

8 《零式水上観測機》

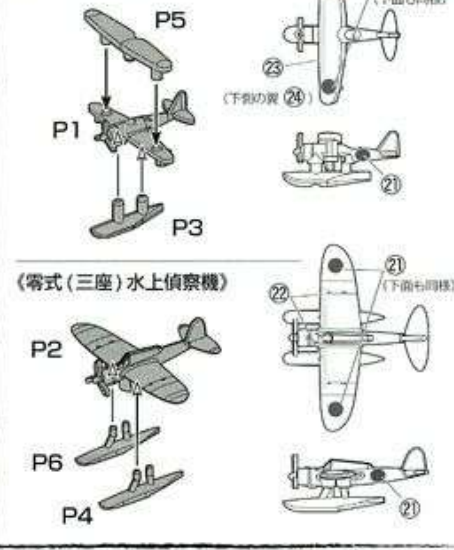

《零式(三座)水上偵察機》

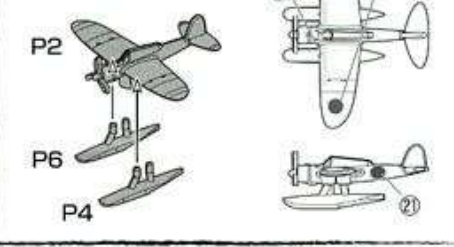

9 《艦橋》

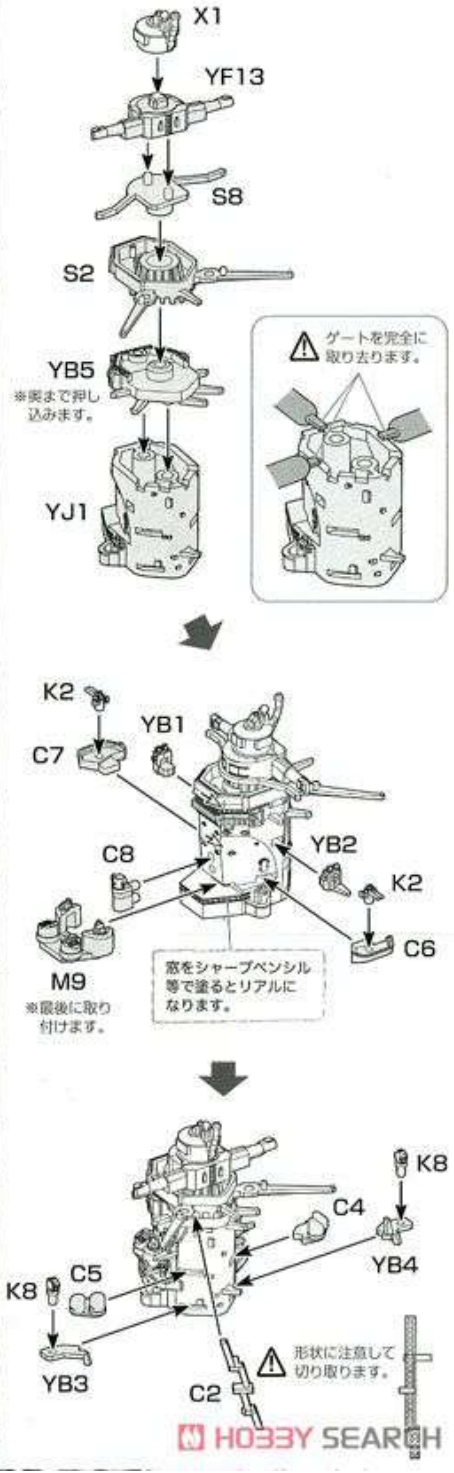

13

- 《Z6,7》探照灯
×2
- 《機銃》
×2

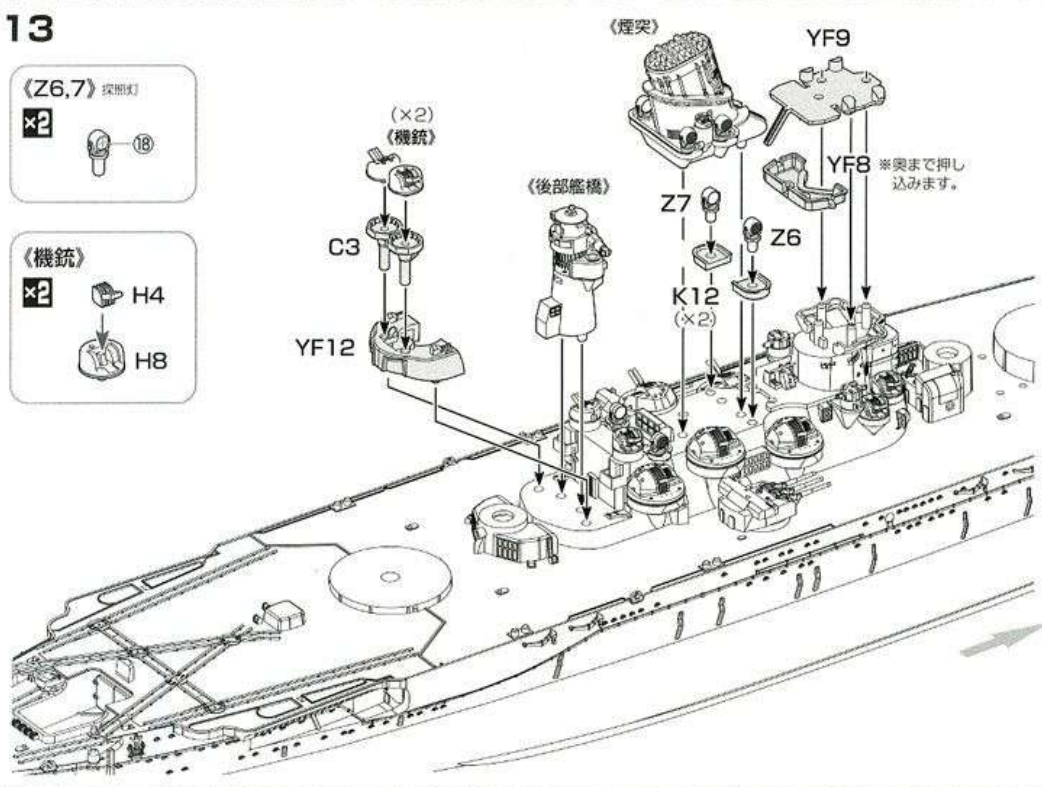

14

- 《主砲》
×3

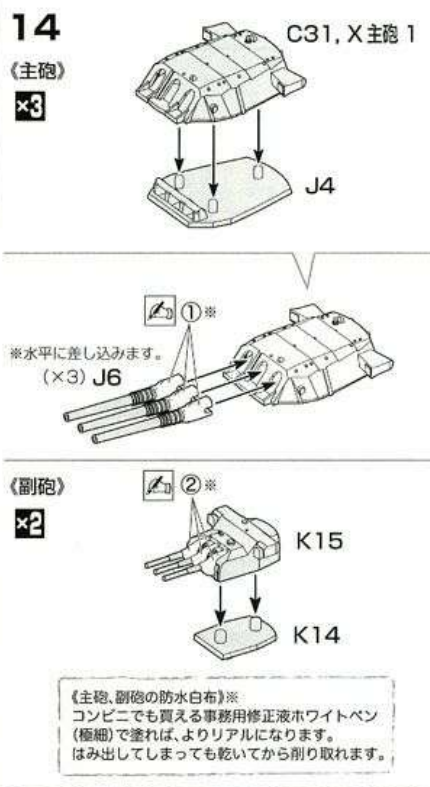

15

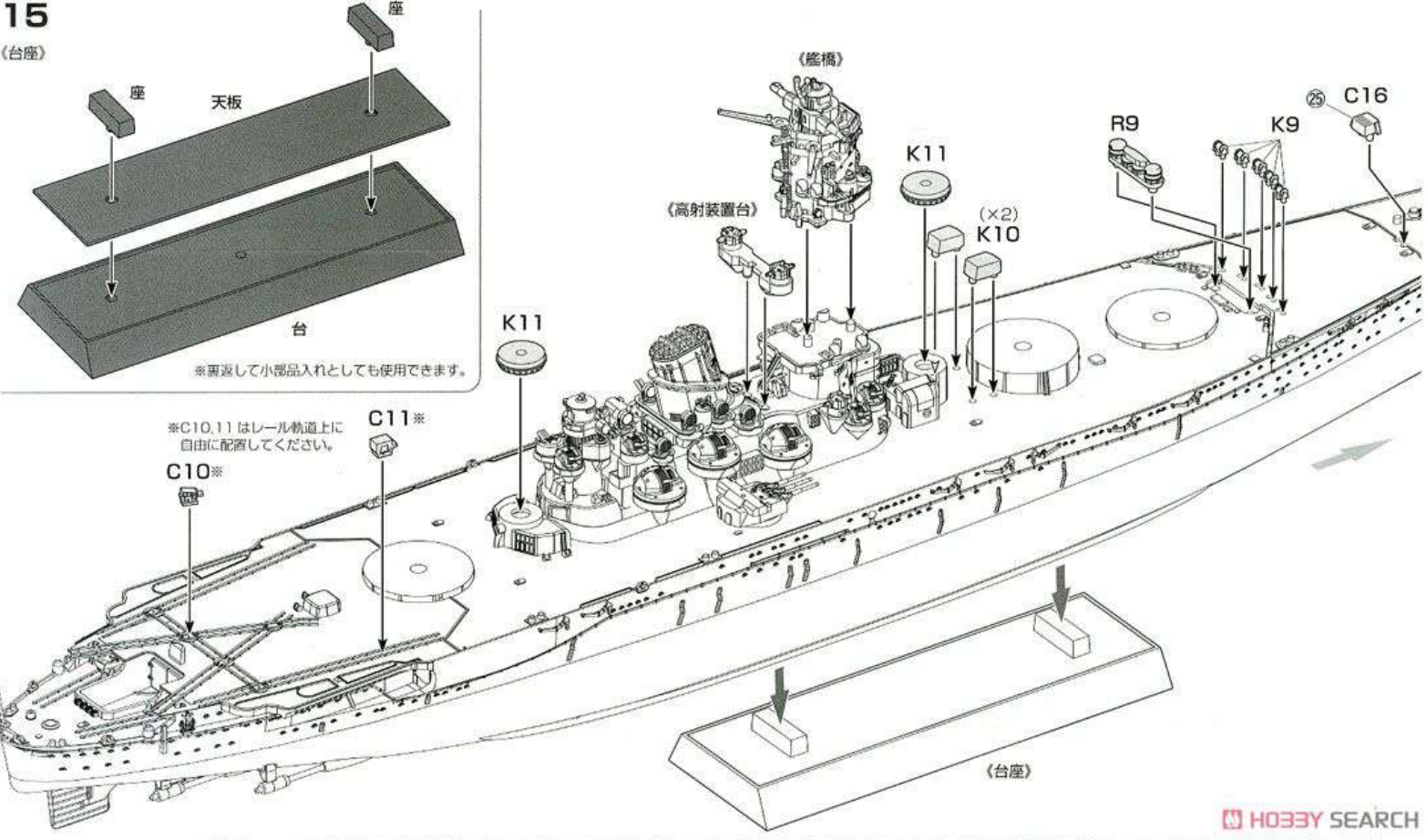
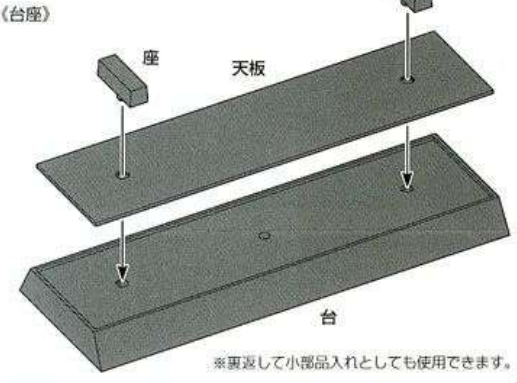

16

《零式水上観測機》

※艦載機を搭載しないときは凸部を切り取ります。

《零式(三座)水上偵察機》

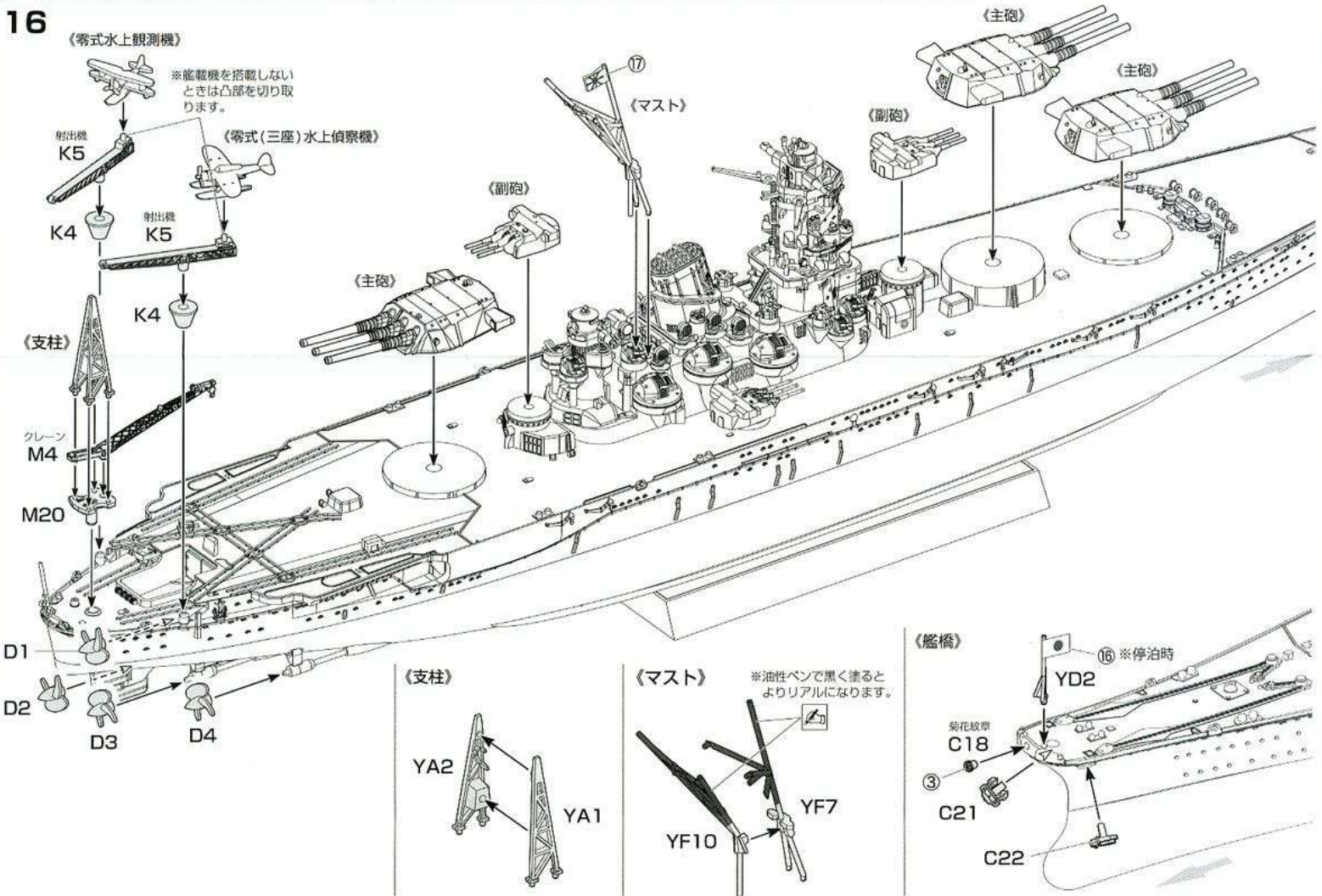

《支柱》

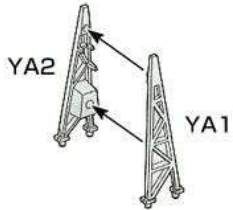

《マスト》

※油性ペンで黒く塗るとよりリアルになります。

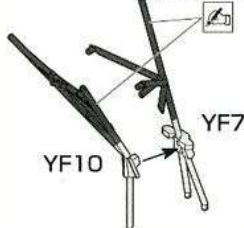

《艦橋》

16 ※停泊時

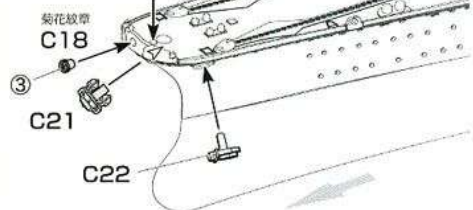

《ボーナスパーツを使って、さらにディテールアップ!》 ボナスパーツを使うと、さらにリアリティを高めます。接着剤(別売)を使用し、取り付けましょう。

《副砲》 x2

【完成図】

(K14,15)

《探照灯》 N1 (x2)

《水平双眼望遠鏡》

YH1 (x14)

【上面図】

《弾薬箱》

お手持ちの資料を参考に甲板上に自由に配置しましょう。

G1