



Light tank T-70 was designed in 1944 instead of light tank T-60. The mass production began since 1942. In September 1942 the German High Command decided to produce a new tank, the standard which for reconnaissance and observation. Production ceased in autumn 1943. During this period 8228 tanks T-70 and T-70 M more released at the Gorki, Sverdlovsk and Kiev plants.  
 Tank T-70 was widely applied at all sectors of Soviet-German fronts as a line tank up to the middle of 1944 and as a reconnaissance tank of the light self-propelled artillery *ap* to the end of the war.  
 Besides the Red Army, Polish Army and Czechoslovak corps was used 1942-1943. T-70 and T-70M total made about half of tanks pack of the Army.  
 In German Army the captured tanks T-70M were applied as line tanks and with the Germanized turret as artillery tractors.

Легкий танк Т-70 был разработан осенью 1941 г. в ИС Горьковского Автозавода под руководством И.А. Аврамова для замены танка Т-60. В сентябре 1942 г. командование приняло решение о создании нового танка, стандарт которого был разработан в сентябре 1942 г. Производство танков Т-70 М с усиленной ходовой частью, замененным лопком механизмов-подвески и другими совершенствовало до осени 1943 г. В этот период было выпущено 8228 танков Т-70 и Т-70М. Танки Т-70 широко применялись на всех участках Советско-Германского фронта до середины 1944 г. и в качестве танков разведки артиллерии.  
 Кроме того, танки Т-70 и Т-70М составляли около половины танкового парка Красной Армии. Многие танки Т-70М применялись как линейные и с доработанной башней как артиллерийские тракторы.

**Technical & Tactical Description**

Modification	September 1942 - September 1943
Date of production	T-70M
Dimensions, mm:	308
Length	2420
Width	2035
Height	2035
Engine type	2 x self-propelled GAZ-203
Engine power, h.p.	2 x 70
Max. speed, km/h	35, 45
Max. range, km	15, 45
Armor thickness, mm:	35
Hull side	35
Turret	35
Crew, mm	1 x 45 mm, 2 x 103mm anti-air gun
Armament	1 x 7,62 mm DT machine gun

**Тактико-технические характеристики**

Модификация	Сентябрь 1942 - Сентябрь 1943
Период производства	T-70M
Размеры, мм:	308
Длина	2420
Ширина	2035
Высота	2035
Тип двигателя	2 x самодвижитель ГАЗ-203
Мощность двигателя, л.с.	2 x 70
Макс. скорость, км/ч	35, 45
Значис. запас, км	15, 45
Толщина брони, мм:	35
Бортовая	35
Башенная	35
Экипаж, чел.	1 x 45 мм, 2 x 103мм зенит. пуля
Вооружение	1 x 7,62 мм ДТ пулемет

**CAUTION**

When you glue or sand, do not use your open mouth. Do not breathe the dust. Do not use your hands to touch your face. Do not use your hands to touch your eyes. Do not use your hands to touch your mouth. Do not use your hands to touch your nose. Do not use your hands to touch your ears. Do not use your hands to touch your hair. Do not use your hands to touch your skin. Do not use your hands to touch your clothes. Do not use your hands to touch your shoes. Do not use your hands to touch your socks. Do not use your hands to touch your underwear. Do not use your hands to touch your pants. Do not use your hands to touch your shorts. Do not use your hands to touch your pajamas. Do not use your hands to touch your nightgown. Do not use your hands to touch your nightdress. Do not use your hands to touch your nightgown. Do not use your hands to touch your nightdress. Do not use your hands to touch your nightgown. Do not use your hands to touch your nightdress.

**ATTENTION**

Ne pas utiliser ses mains ou ses pieds à proximité d'une source de poussière. Ne pas respirer la poussière. Ne pas utiliser ses mains pour toucher son visage. Ne pas utiliser ses mains pour toucher ses yeux. Ne pas utiliser ses mains pour toucher sa bouche. Ne pas utiliser ses mains pour toucher son nez. Ne pas utiliser ses mains pour toucher ses oreilles. Ne pas utiliser ses mains pour toucher ses cheveux. Ne pas utiliser ses mains pour toucher sa peau. Ne pas utiliser ses mains pour toucher ses vêtements. Ne pas utiliser ses mains pour toucher ses chaussures. Ne pas utiliser ses mains pour toucher ses chaussettes. Ne pas utiliser ses mains pour toucher son sous-vêtement. Ne pas utiliser ses mains pour toucher ses pantalons. Ne pas utiliser ses mains pour toucher ses shorts. Ne pas utiliser ses mains pour toucher ses pyjamas. Ne pas utiliser ses mains pour toucher sa robe de nuit. Ne pas utiliser ses mains pour toucher son peignoir. Ne pas utiliser ses mains pour toucher son peignoir. Ne pas utiliser ses mains pour toucher son peignoir. Ne pas utiliser ses mains pour toucher son peignoir. Ne pas utiliser ses mains pour toucher son peignoir. Ne pas utiliser ses mains pour toucher son peignoir.

**ATTENZIONE**

Non usare mani o piedi vicino a una sorgente di polvere. Non respirare la polvere. Non usare mani o piedi per toccare il viso. Non usare mani o piedi per toccare gli occhi. Non usare mani o piedi per toccare la bocca. Non usare mani o piedi per toccare il naso. Non usare mani o piedi per toccare le orecchie. Non usare mani o piedi per toccare i capelli. Non usare mani o piedi per toccare la pelle. Non usare mani o piedi per toccare i vestiti. Non usare mani o piedi per toccare le scarpe. Non usare mani o piedi per toccare i calzini. Non usare mani o piedi per toccare i pantaloni. Non usare mani o piedi per toccare i shorts. Non usare mani o piedi per toccare i pigiama. Non usare mani o piedi per toccare la camicia da notte. Non usare mani o piedi per toccare il pigiama. Non usare mani o piedi per toccare il pigiama. Non usare mani o piedi per toccare il pigiama. Non usare mani o piedi per toccare il pigiama. Non usare mani o piedi per toccare il pigiama.

**x2**

DO NOT CEMENT  
 MAKE ZIPS  
 EFFECTIVE PEZES  
 GAZ-203  
 VALBAR  
 ПИСТОЛЕТ ДВА РАКА

**OPTIONAL PARTS**

NE PAS COLLER  
 FACILITAE  
 VALBAR  
 ВАЛВАРЫ

**Paint number**

Number of color  
 Variant of color  
 Номер краски  
 Номер детали  
 Вариант окраски

**A**

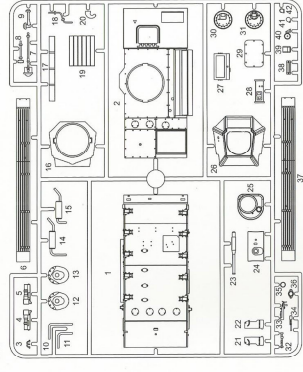

**Bx2**

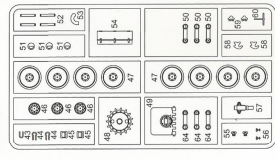

**E**

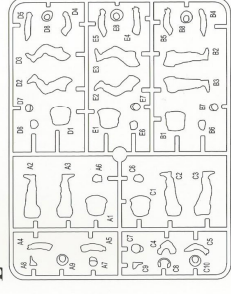

**Cx4**

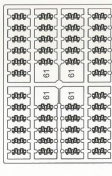

**D**

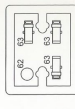

**I**

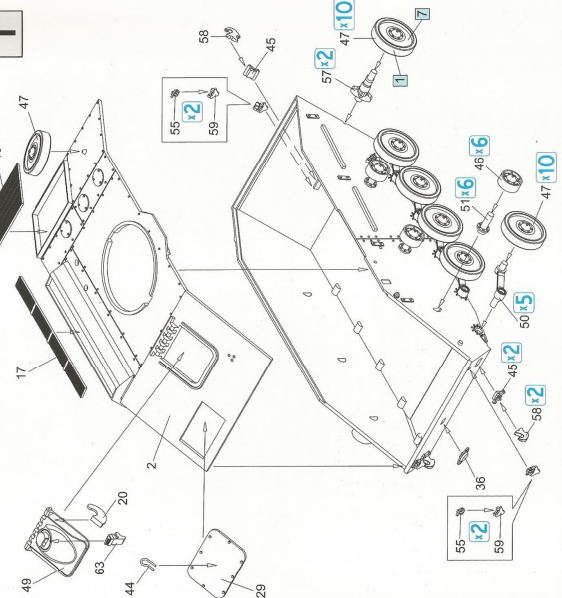

**II**

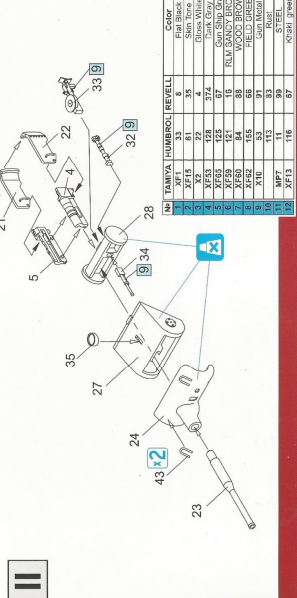

**III**

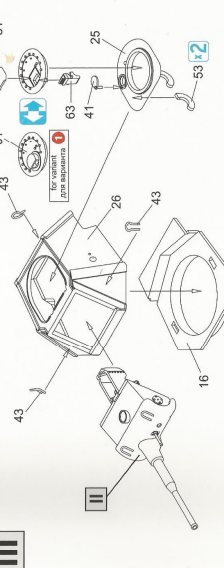

**IV**

№	TAMIYA	HUMBROL	REVELL	Color
1	XF-15	81	35	Steel
2	X2	22	4	Gun Black
3	X2	22	4	Gun Black
4	X2	22	4	Gun Black
5	XF68	128	67	Cross White
6	XF68	128	67	Cross White
7	XF68	128	67	Cross White
8	XF68	128	67	Cross White
9	XF68	128	67	Cross White
10	X10	53	91	Gun Metal
11	MP7	113	63	Flint
12	XF13	116	67	Khaki green

№	TAMIYA	HUMBROL	REVELL	Color
1	X15	81	35	Steel
2	X2	22	4	Gun Black
3	X2	22	4	Gun Black
4	X2	22	4	Gun Black
5	XF68	128	67	Cross White
6	XF68	128	67	Cross White
7	XF68	128	67	Cross White
8	XF68	128	67	Cross White
9	XF68	128	67	Cross White
10	X10	53	91	Gun Metal
11	MP7	113	63	Flint
12	XF13	116	67	Khaki green

№	TAMIYA	HUMBROLD	REVELL	Color
1	XF1	33	8	Flat Black
2	XF2	35	5	Black
3	XF3	22	4	Dark White
4	XF53	128	374	Dark Grey
5	XF55	125	67	Gun Ship Grey
6	XF56	125	67	Gun Ship Grey
7	XF60	84	88	ELK (SANDY BROWN) T2
8	XF62	185	66	WOOD BROWN
9	X10	113	83	FIELD GREEN
10	X10	113	83	FIELD GREEN
11	MP7	11	99	Gun Metal
12	XF13	116	67	STEEL
				Kitsch grün

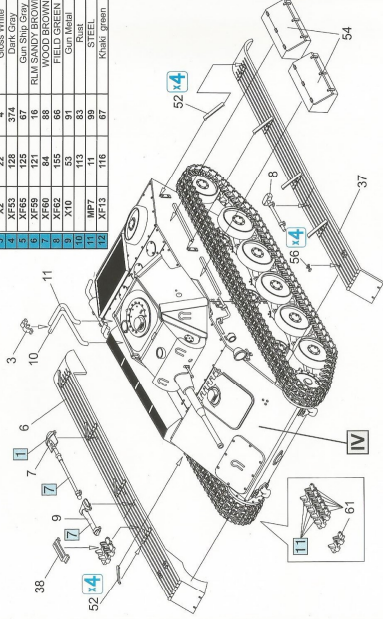

Pz.Krw. T-70 (I), 14 Усиленный завод, 5 Поплицейская танковая рота

Pz.Krw. T-70 743 (I), Werkstatt 14 der 5 (verst.), Polizei Panzer Kompanie

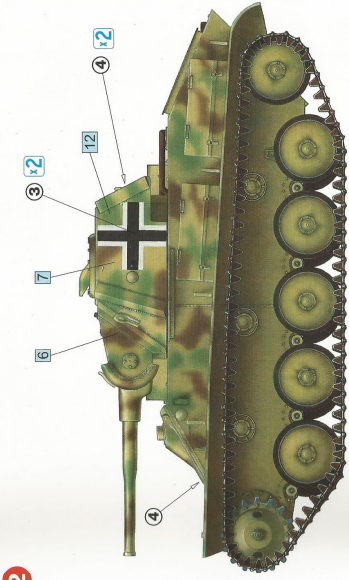

№	TAMIYA	HUMBROLD	REVELL	Color
1	XF1	33	8	Flat Black
2	XF2	35	5	Black
3	XF3	22	4	Dark White
4	XF53	128	374	Dark Grey
5	XF55	125	67	Gun Ship Grey
6	XF56	125	67	Gun Ship Grey
7	XF60	84	88	ELK (SANDY BROWN) T2
8	XF62	185	66	WOOD BROWN
9	X10	113	83	FIELD GREEN
10	X10	113	83	FIELD GREEN
11	MP7	11	99	Gun Metal
12	XF13	116	67	STEEL
				Kitsch grün

82-я легкая дивизия Вермахте  
82 Wehrmacht's Division

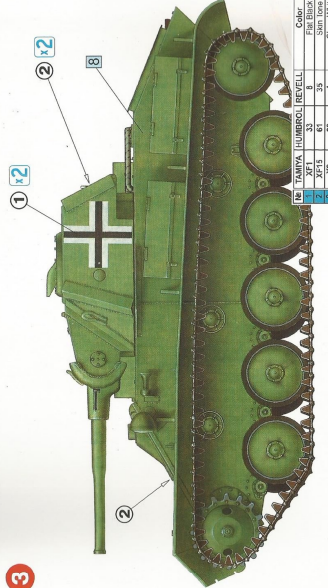

Pz.Krw. T-70 (I), Stug Abteilung 276, район Шлюсберга, Восточная Пруссия, ноябрь 1944 г.

Pz.Krw. T-70 (I), Stug Abteilung 276, Schlossberg region, East Prussia, November 1944

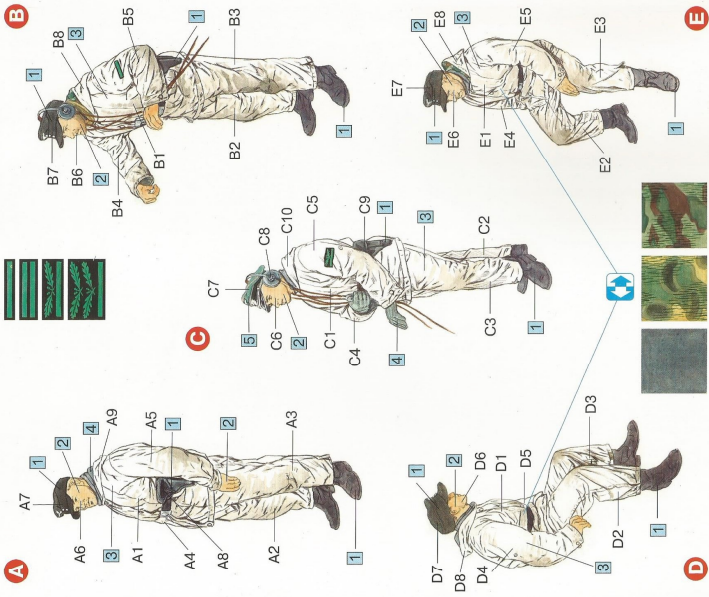
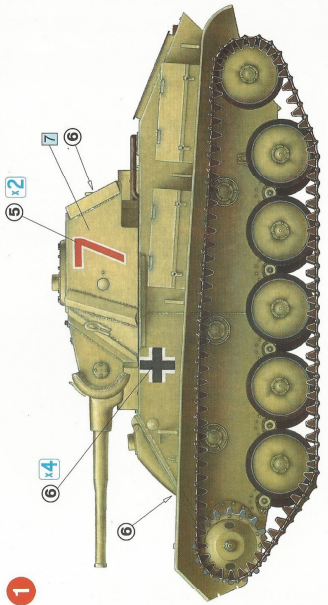

№	TAMIYA	HUMBROLD	REVELL	Color
1	XF1	33	8	Flat Black
2	XF2	35	5	Black
3	XF3	22	4	Dark White
4	XF53	128	374	Dark Grey
5	XF55	125	67	Gun Ship Grey
6	XF56	121	16	ELK (SANDY BROWN) T2
7	XF59	84	88	WOOD BROWN
8	XF62	185	66	FIELD GREEN
9	X10	113	83	Gun Metal
10	MP7	11	99	Rust
11	MP7	11	99	Rust
12	XF13	116	67	STEEL
				Kitsch grün

## Photo's World War II

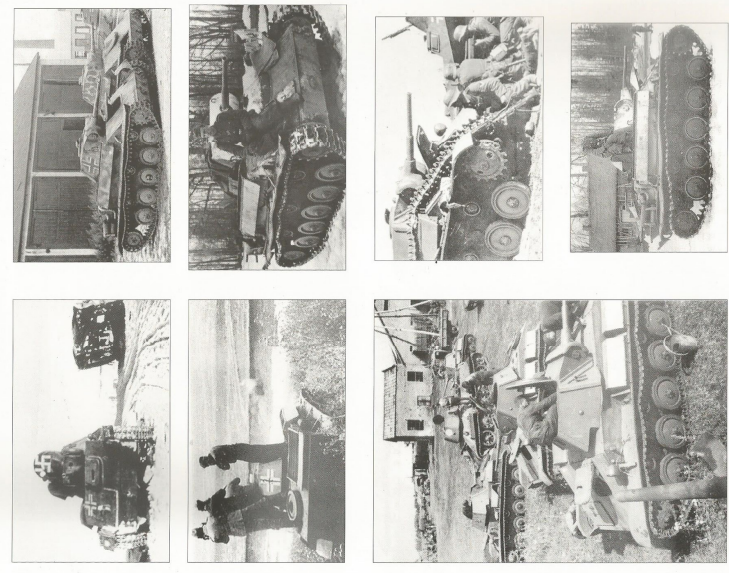

MiniArt Ltd.  
P. Box 1492, Simferopol, 95000, Ukraine  
Tel: +38 0652 249291, E-Mail: [info@miniart-models.com](mailto:info@miniart-models.com)  
[www.miniart-models.com](http://www.miniart-models.com)