

PANTHER Ausf.A

1/35 scale update for Italeri model

ABER 35 006

Made in Poland 1995

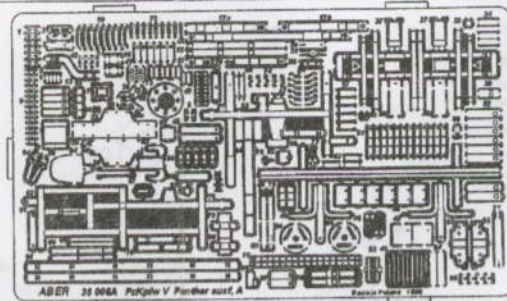

ABER 35 006A Panther V Panther ausf.A

ABER 35 006C Panther V Panther ausf.A

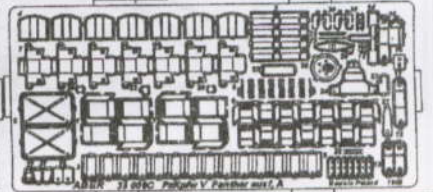
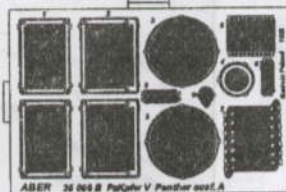
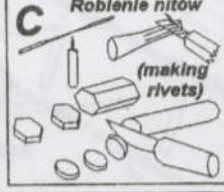
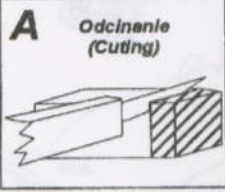

ABER 35 006 B Panther V Panther ausf.A

ABER 35 006 C Panther V Panther ausf.A

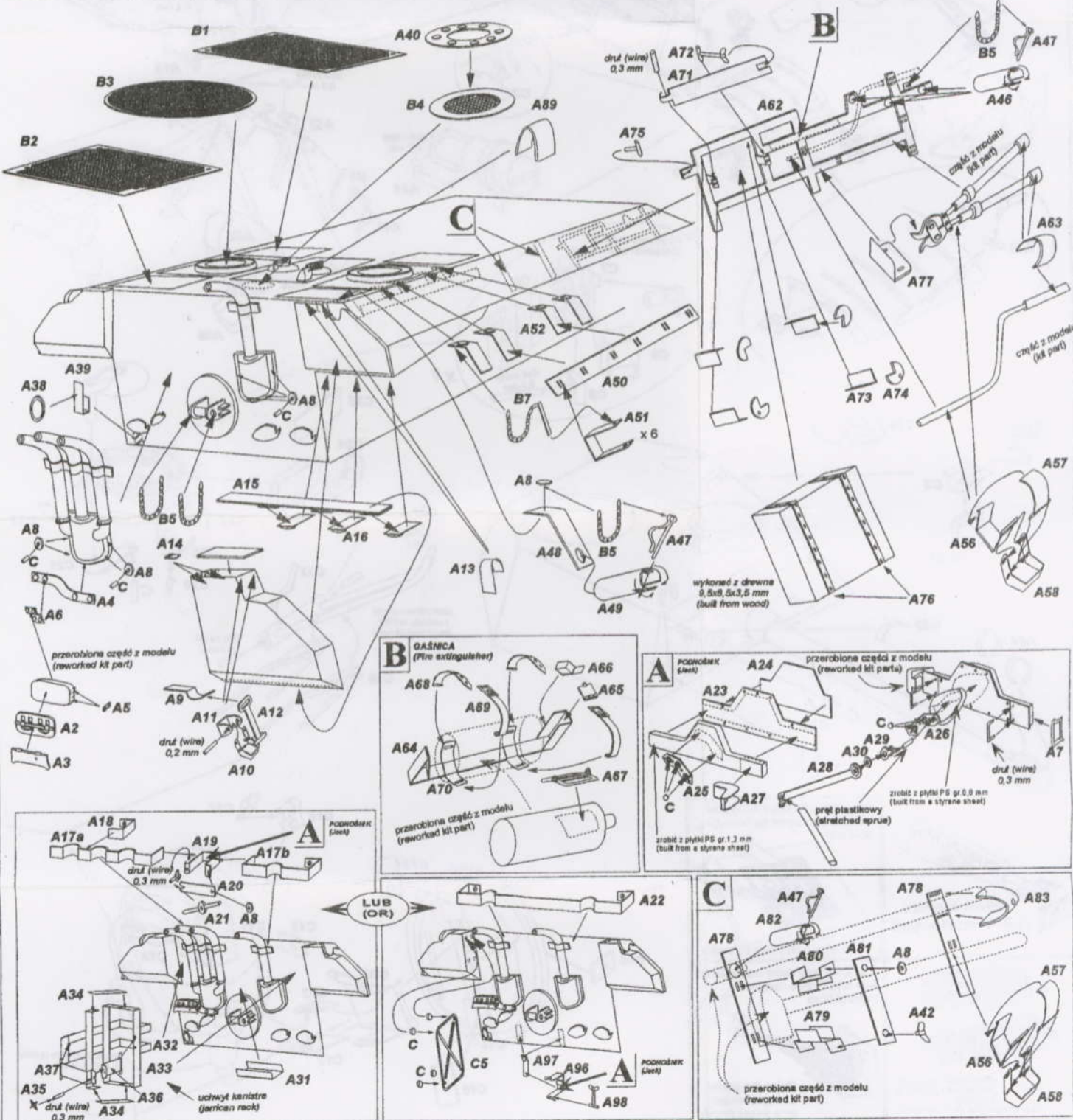

przerobiona część z modelu
(reworked kit part)

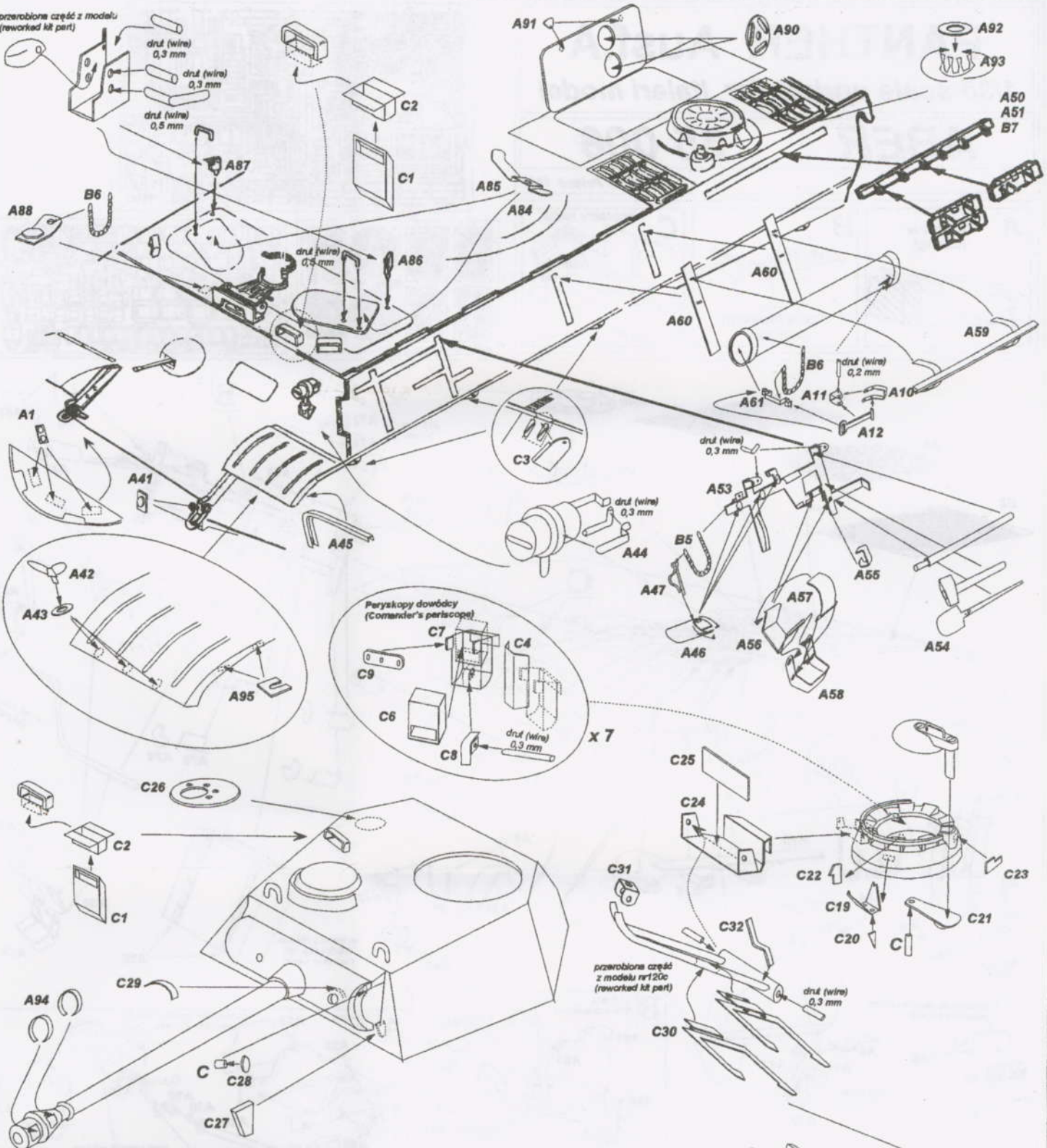

CYANOACRYL GLUE
Kleić klejami cyjanoakrylowymi

Do odcinania użyć nożyczek lub ostrego noża na twardej podłożu
Use sharp knife or scissors

Nierówności spławić pilnikiem lub papierem ściernym
To brush use file or abrasives

Najlepiej malować aerografem lub kilkakrotnie małym pędzikiem
Paint the parts using airbrush or a small brush

