

CMP C15TA Armored Car

Precision plastic model



**1/35
Scale**

**Kit No.
35100**

The C15TA Armoured Truck was developed by GM Canada along a concept lines of the American M3 Scout Car. The vehicle used the chassis of the Chevrolet C15A Canadian Military Pattern truck design. Between 1943 and 1945 a total of 3,961 units were built in Oshawa, Ontario. Armoured hulls were supplied by the Hamilton Bridge Company

The C15TA was used by the British and Canadian units in the Northwest Europe campaign as armoured personnel carrier and ambulance. After the end of the hostilities, many vehicles were left in Europe and were subsequently employed by armies of the liberated European countries, including Belgium, Denmark, the Netherlands, Norway. In addition about 150 were sold by Canada to Spain. Trucks left by the British forces in Vietnam were taken over by the French, which used them in Indochina and later transferred to South Vietnam. Many C15TAs were employed by the police forces of the Federation of Malaya. In 1955 Portugal received a number of vehicles, which were later used in the African wars. Some vehicles remained in service until the 1960s.

1/35 Detail set for C15TA Armored Carrier





No.35414
WWW.LZmodels.com
Made in EU

contains 1 highly detailed and accurate set
Detailing set for Mirror Models C15TA kit (tools set, stowage set, glass windows assembly, seats)

13 resin parts
40+ PE parts
wire needed for assembly

instructions and references on CD

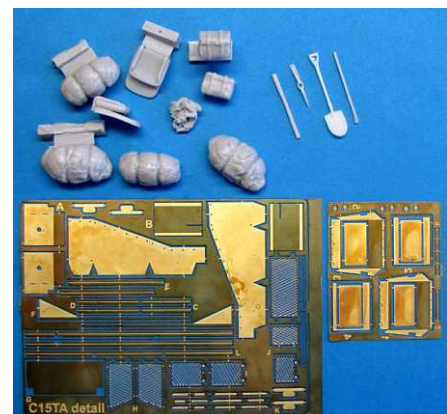
glue and paints not included
suitable for advanced modellers
keep safety rules for work with resin



If you are going to use also LZ Models detailing set for this build, check out its assembly instruction first - many parts will be much easier to assemble during your work, especially "Glass windows assembly" and some other interior details will be better to glue in before you complete whole body together

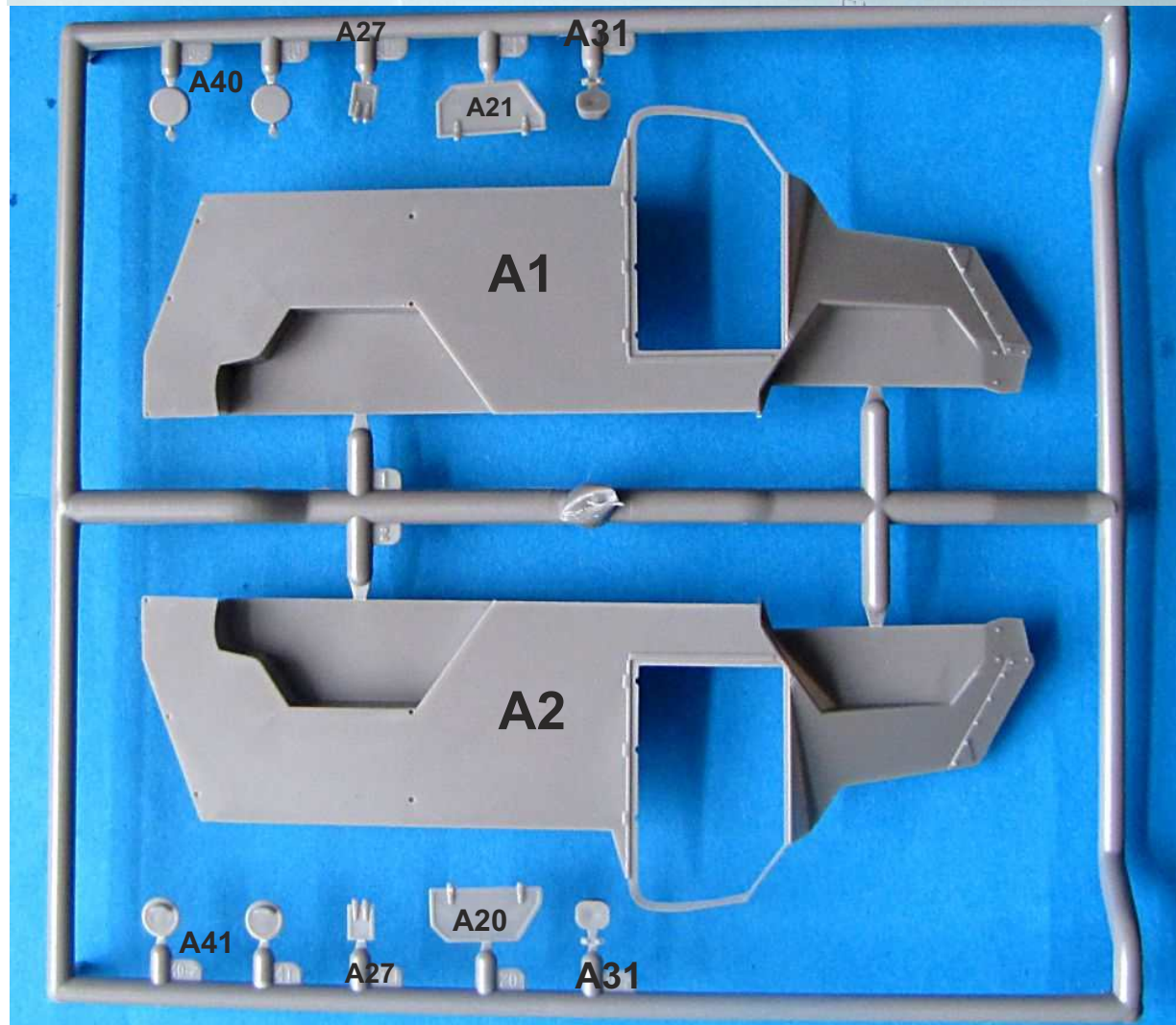
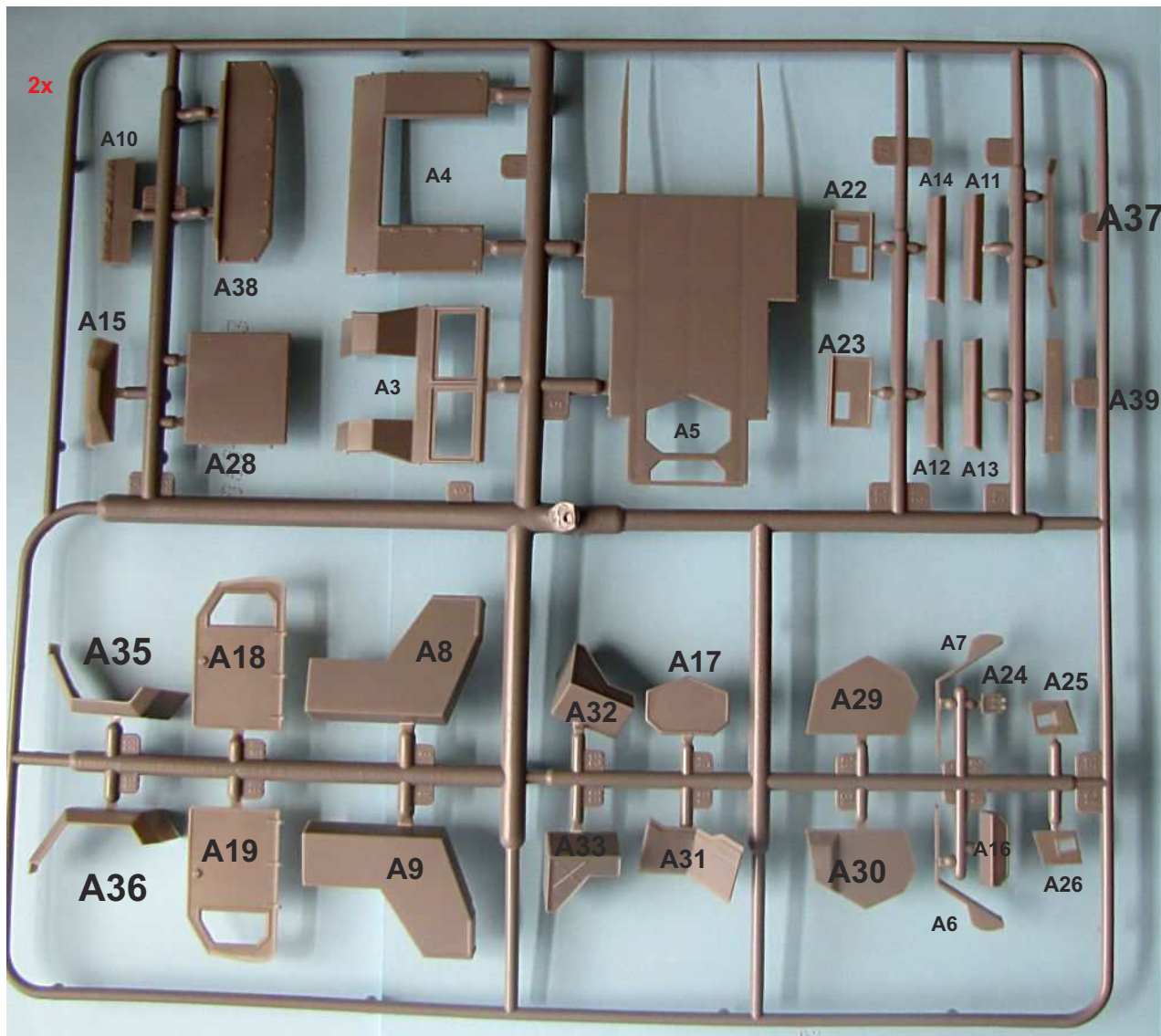

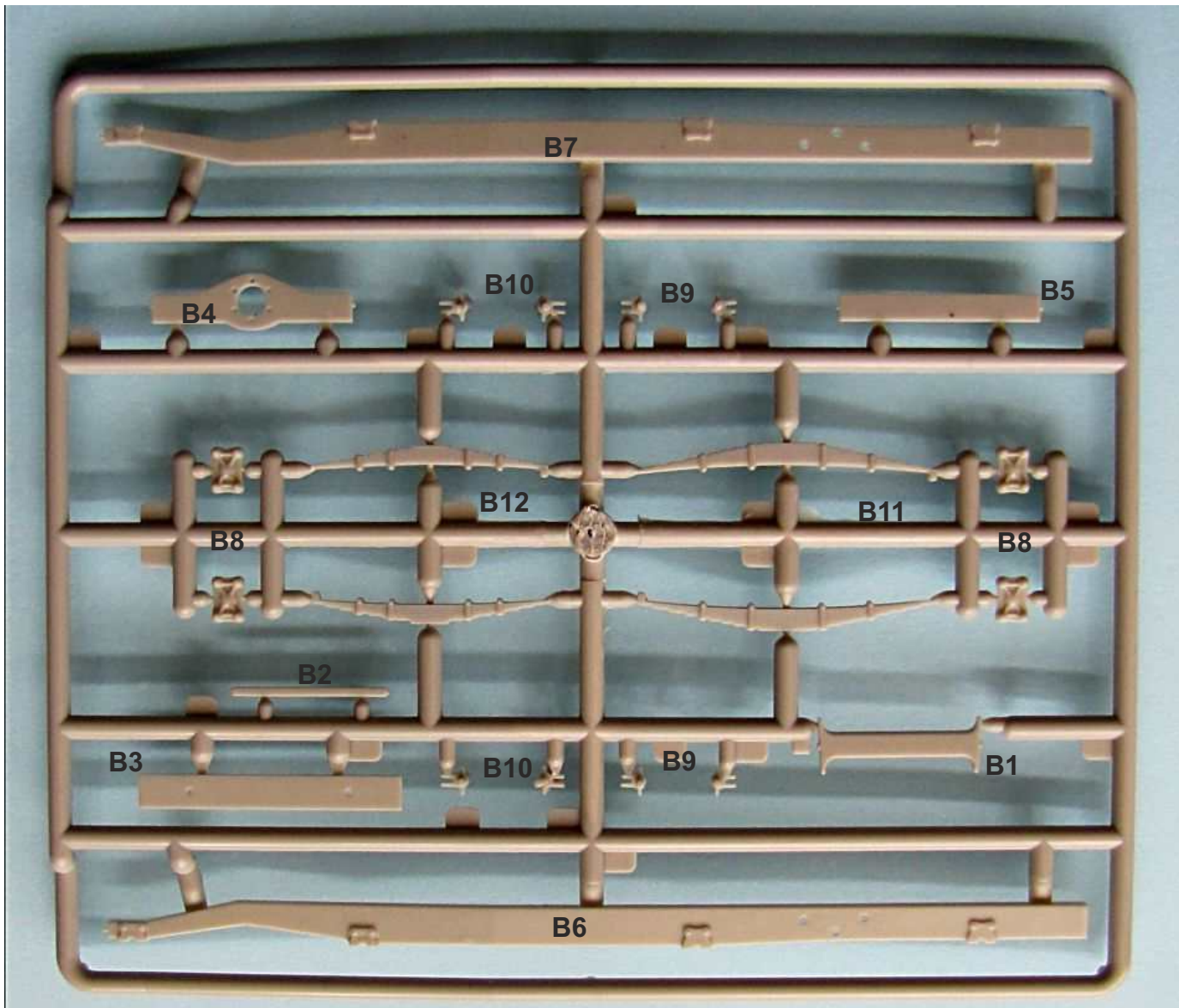

Front L

Back R



Front right

Back L

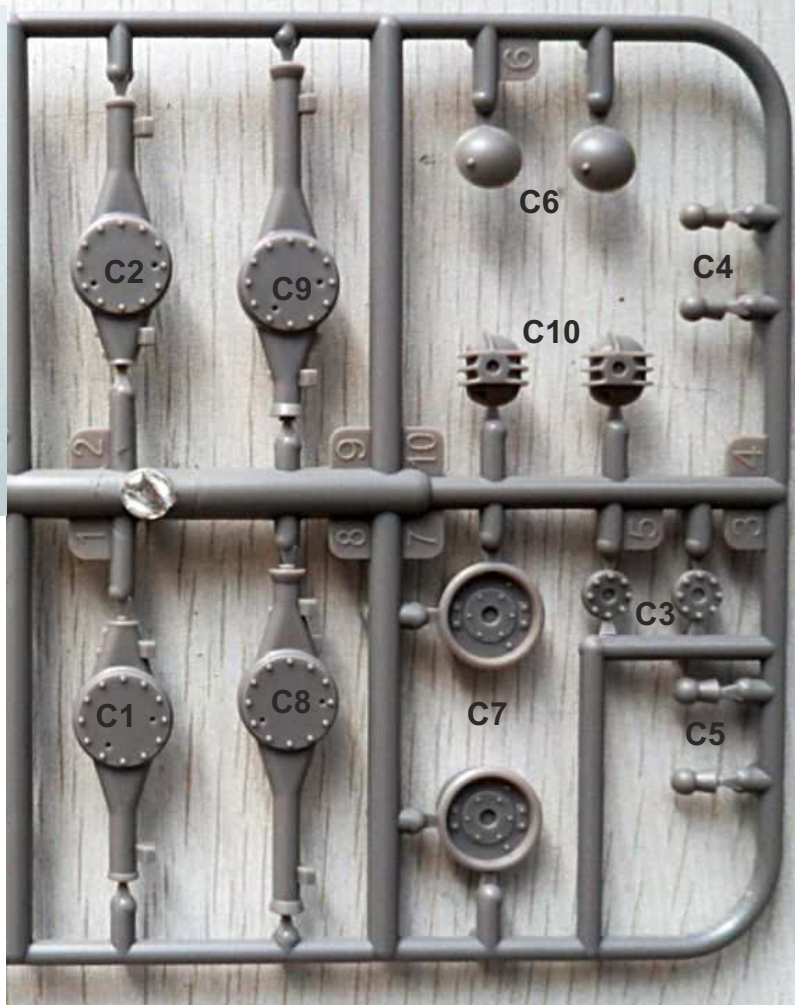

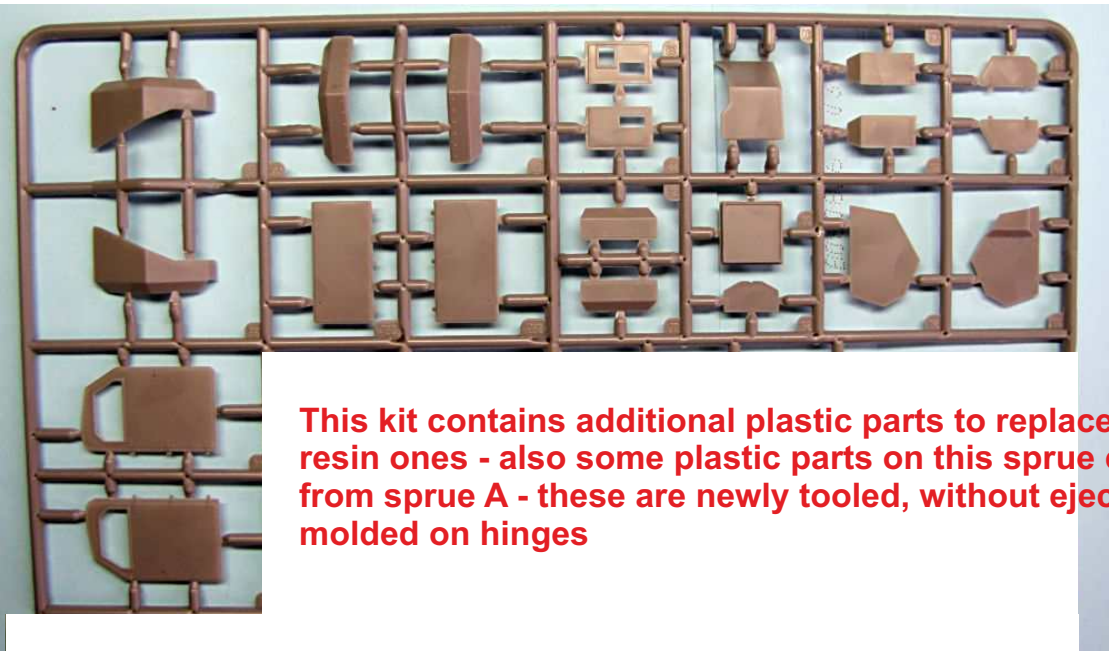

This kit contains additional plastic parts to replace originally used resin ones - also some plastic parts on this sprue can replace parts from sprue A - these are newly tooled, without ejector marks, with molded on hinges

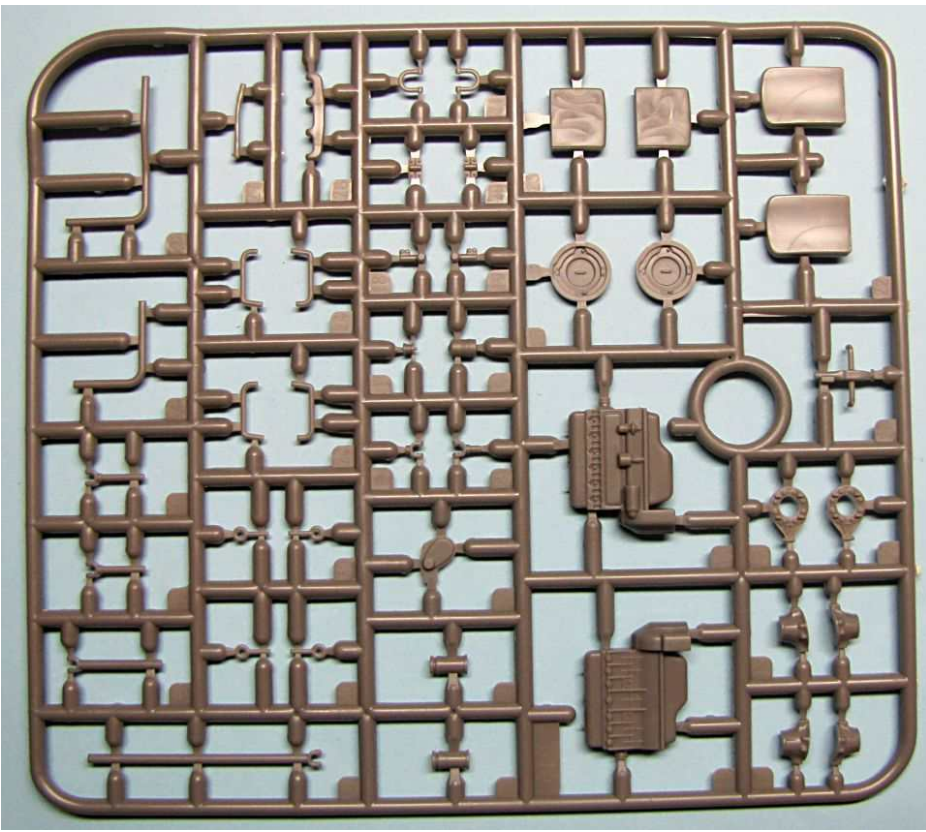
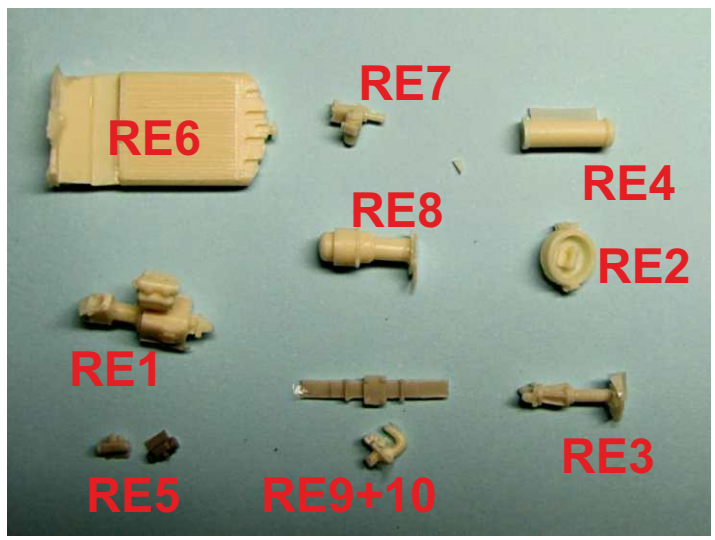
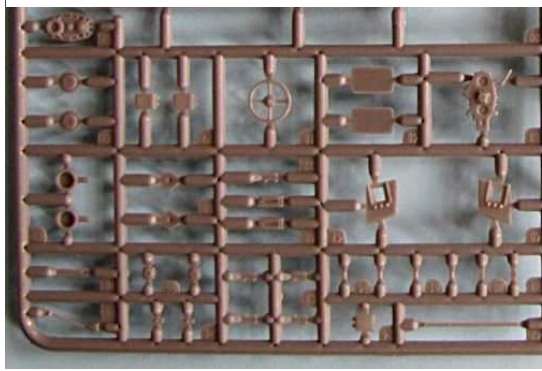

Z

Go through assembly guide before you start your work
Extended Assembly guide and part list to download at

www.Mirror-models.com

Heat up PE parts with lighter before use,
 brass will soften and become easy
 to bend and work with
 Tamiya Super Thin Glue recommended
 for plastic parts

**pins on crossbeams into
 holes in frame sides**

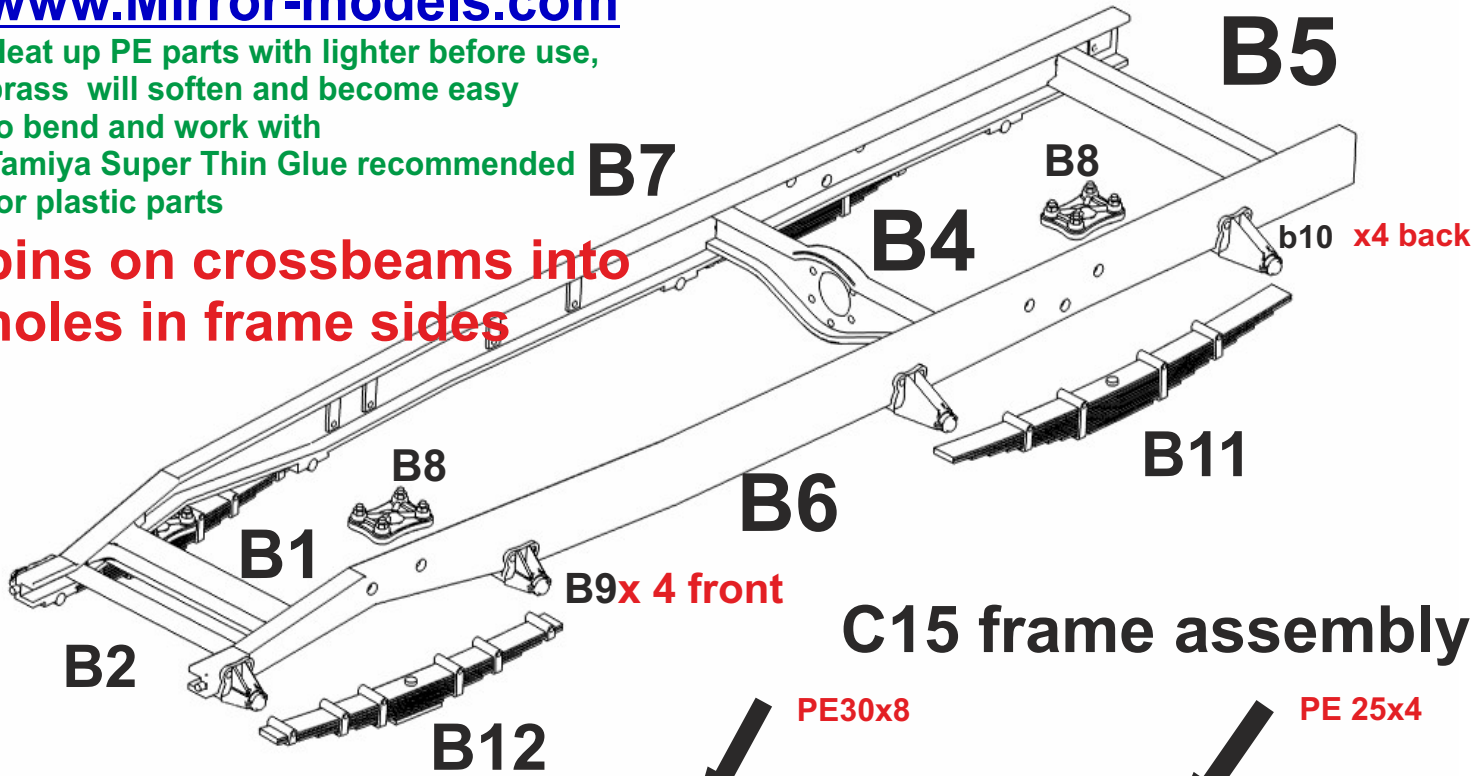

C15 frame assembly

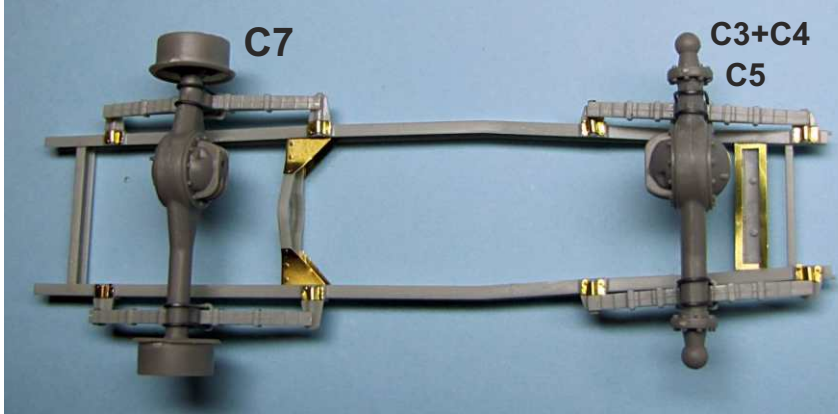
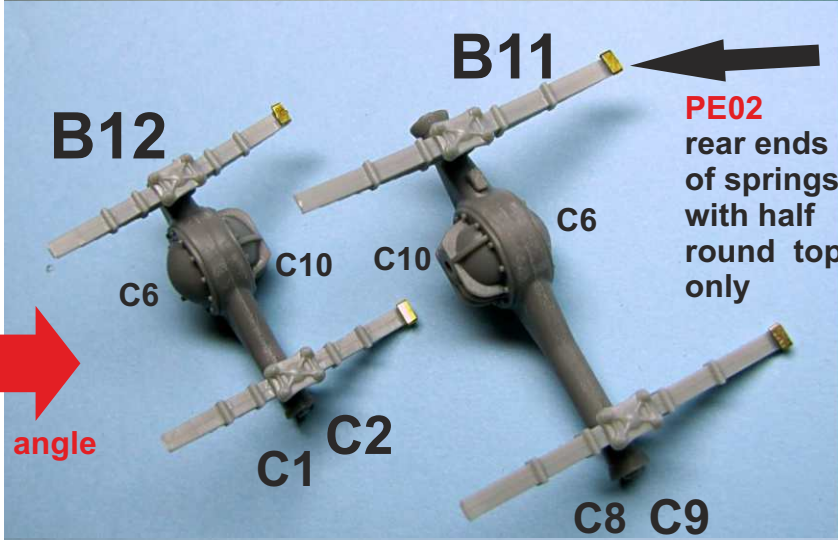
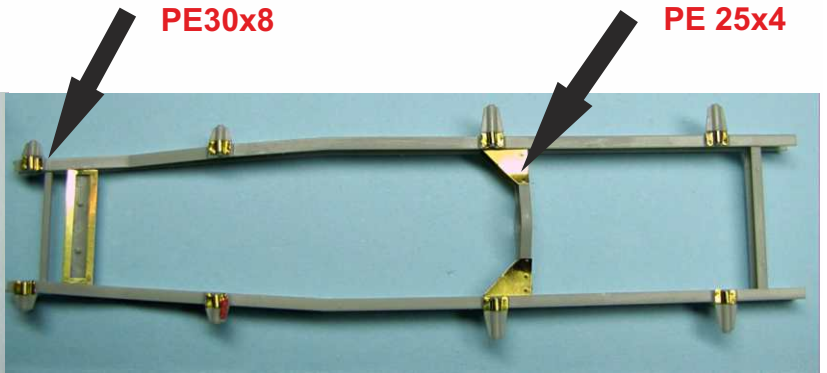
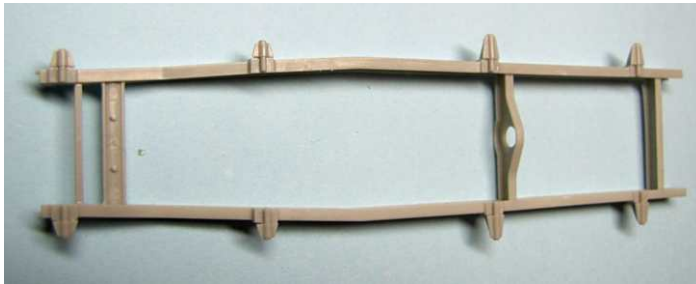

Set angle between front springs according to angle between front holders B9 before you glue springs on C1+C2, check before glue dries...
Make clamps with 0,5mm wire and then glue both differentials on their holders

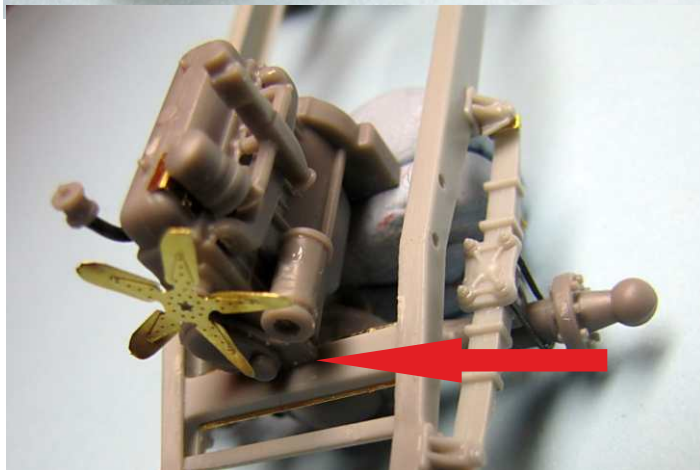
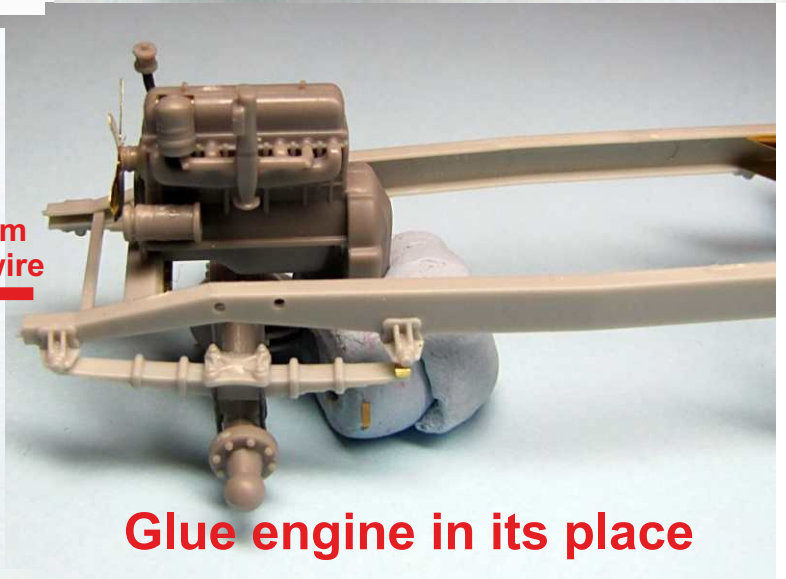
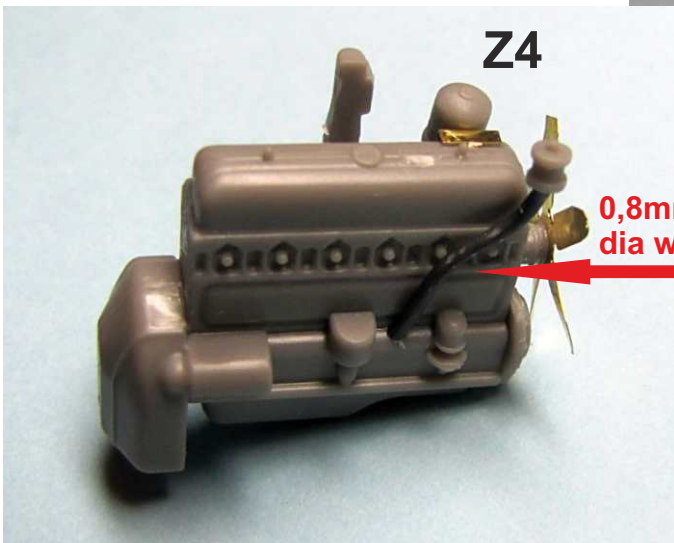
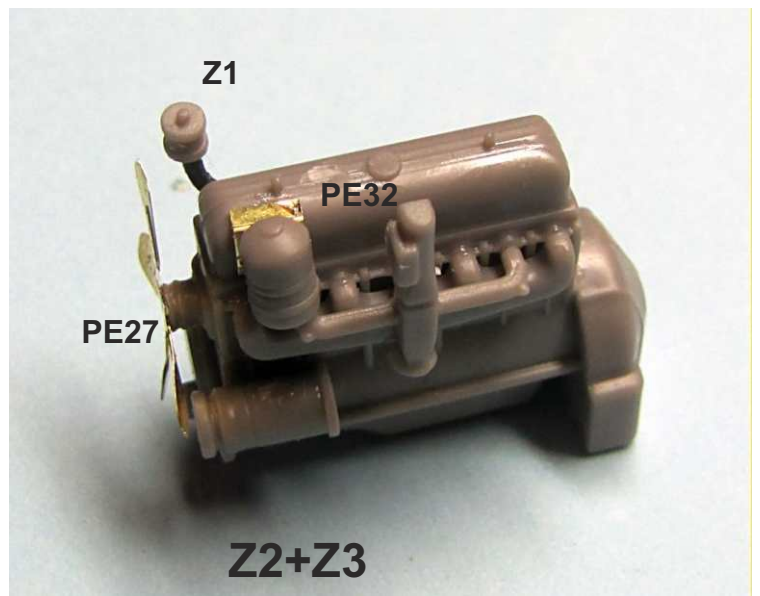
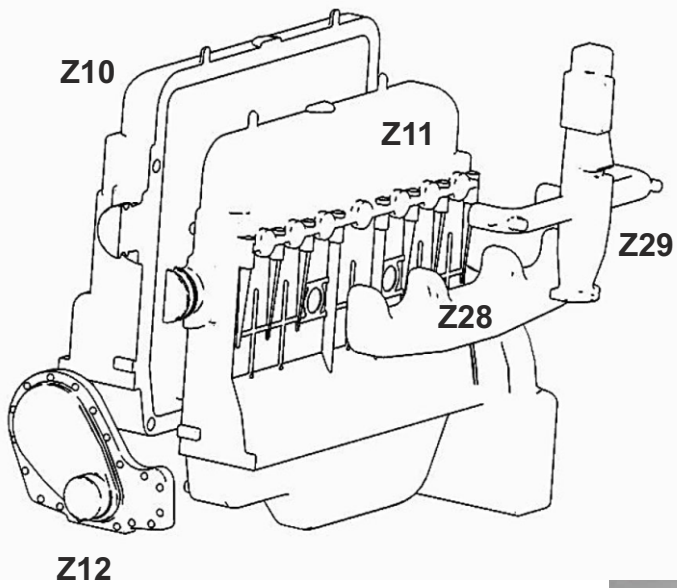

Now you should leave frame assembly and build up the body base that will be needed to fit gear boxes properly and easy. Once body base is ready, return here and finish the frame

complete Z8+Z9, A52+A53, A54+A55 and assemble

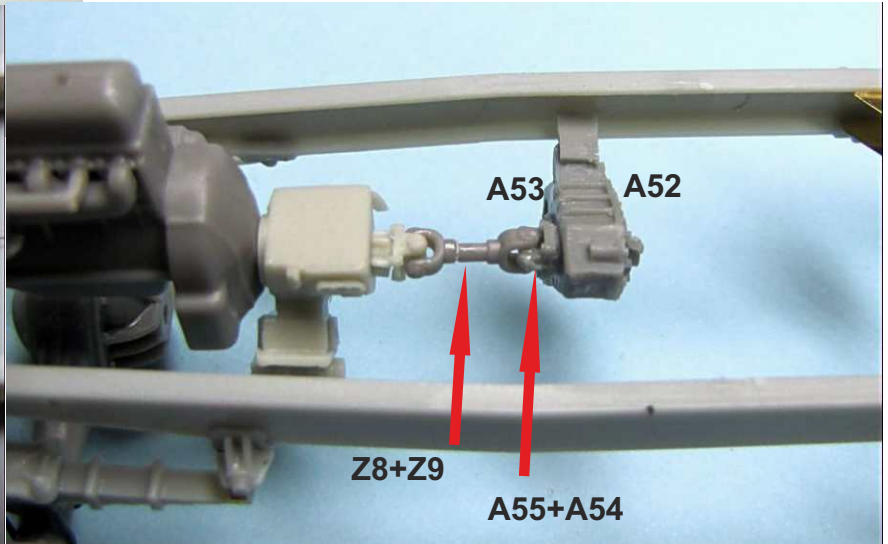
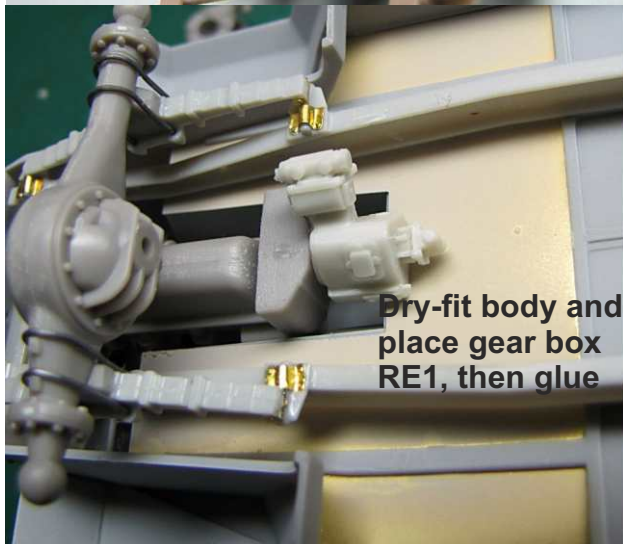

PE22

PE23x4

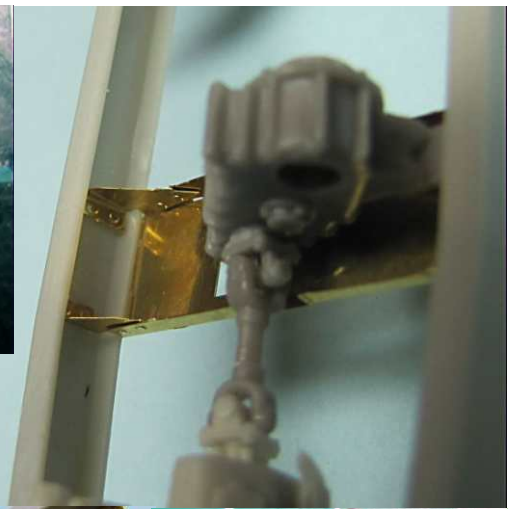
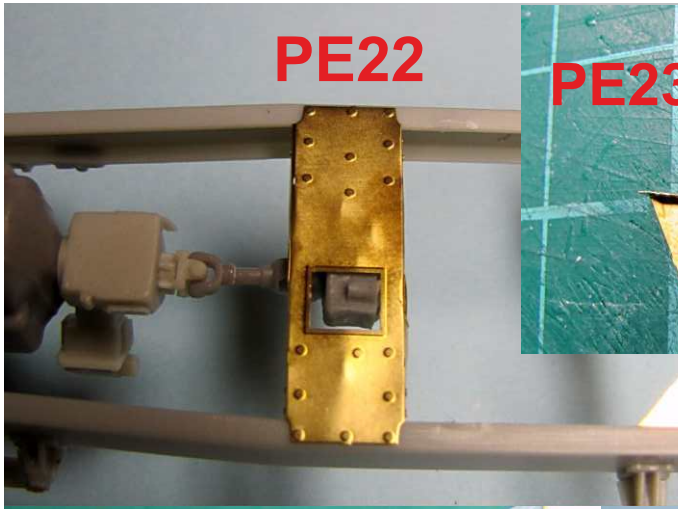

PE21x2

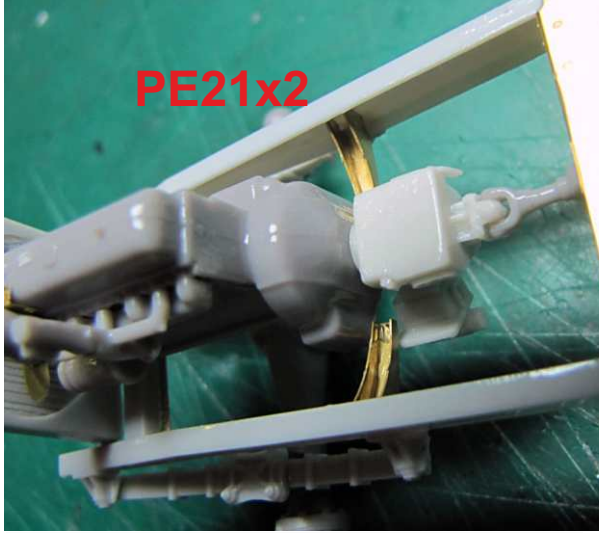

PE21

Can drill hole for 0,6mm wire

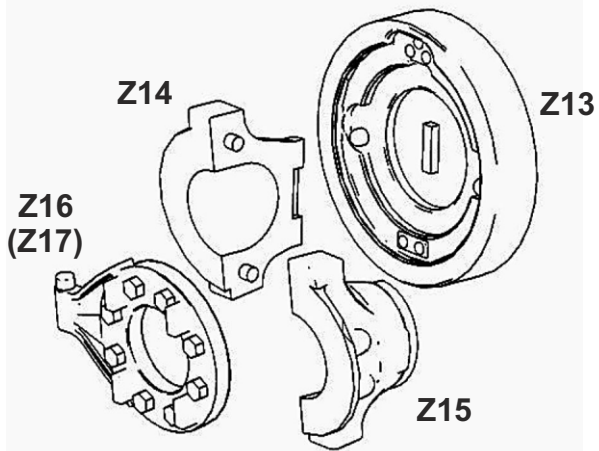

Z18 (Z19)

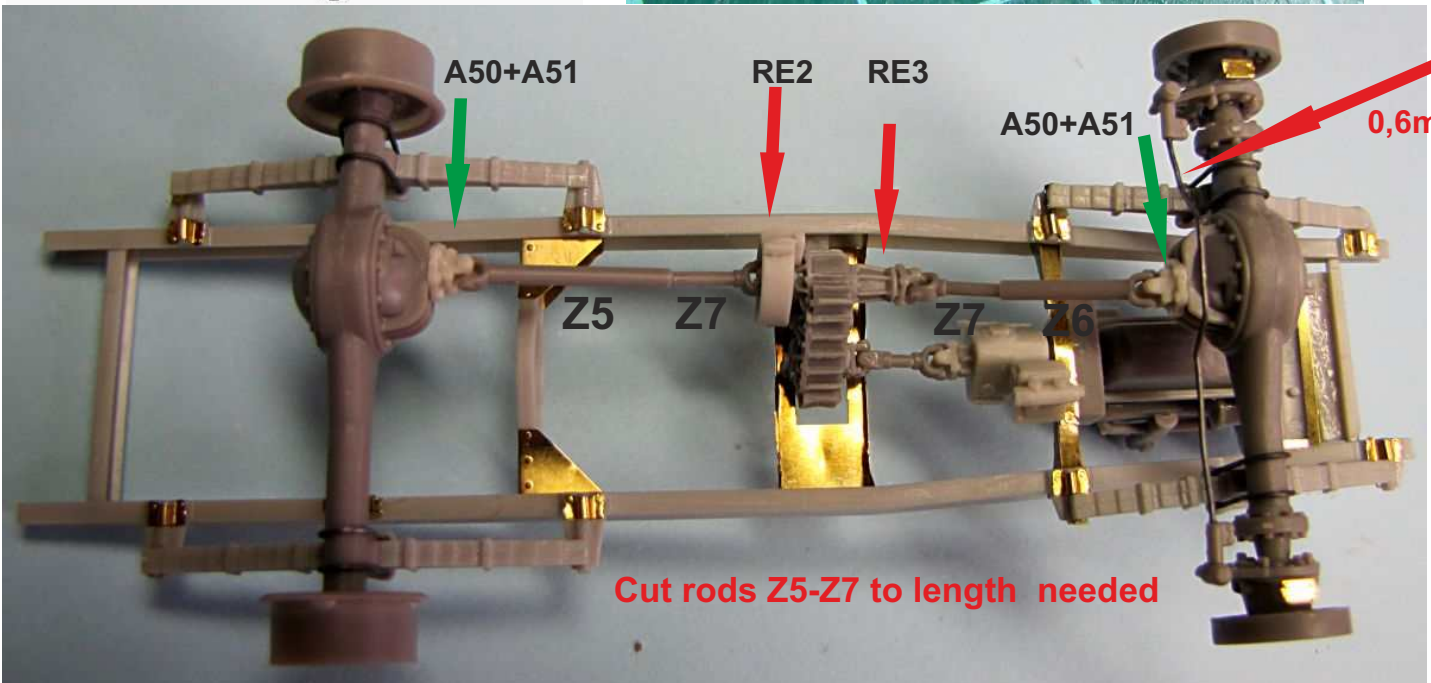

A50+A51

RE2

RE3

A50+A51

Z5

Z7

Z7

Z6

Z7

0,6mm wire

Cut rods Z5-Z7 to length needed

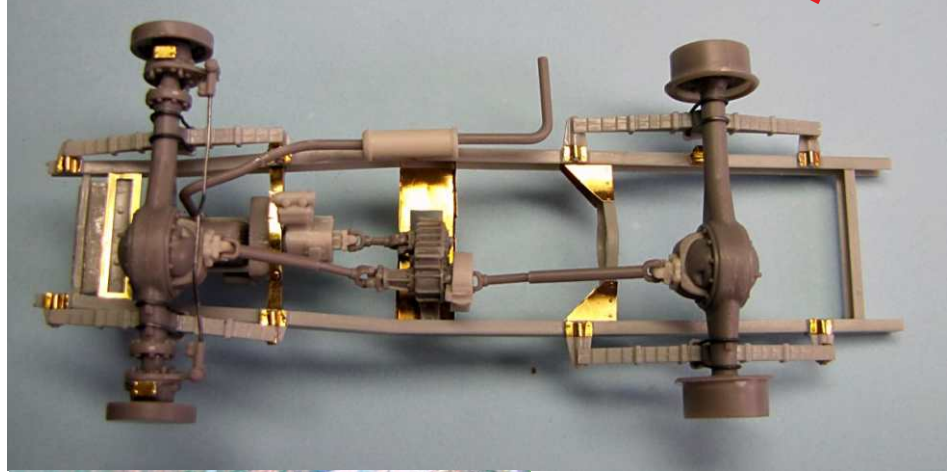
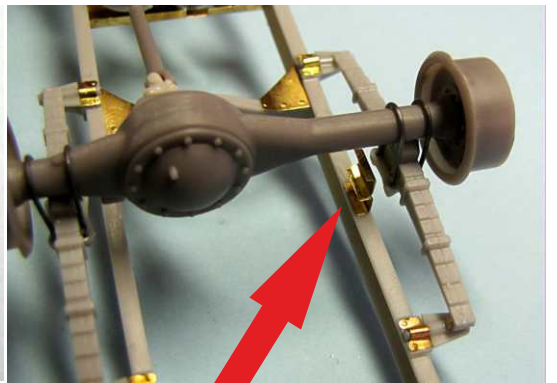
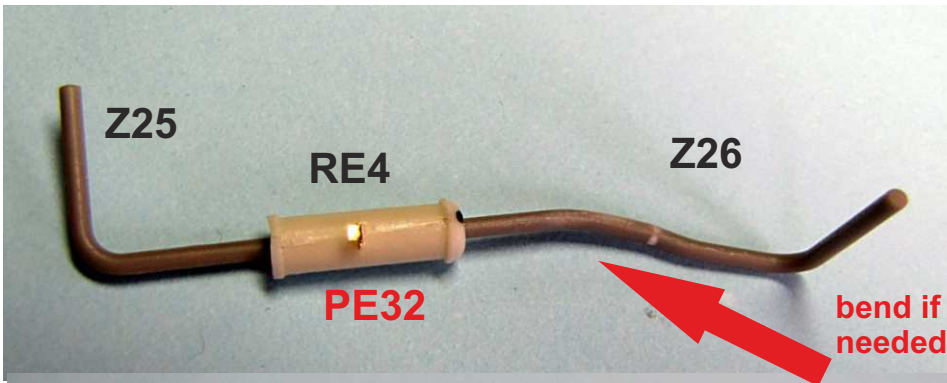

Shock absorbers in the kit are meant rather optional for additional details, PE parts are tiny a require some patience (PE33-35 can be also replaced by simple piece of 0,3mm dia wire for easier handling)

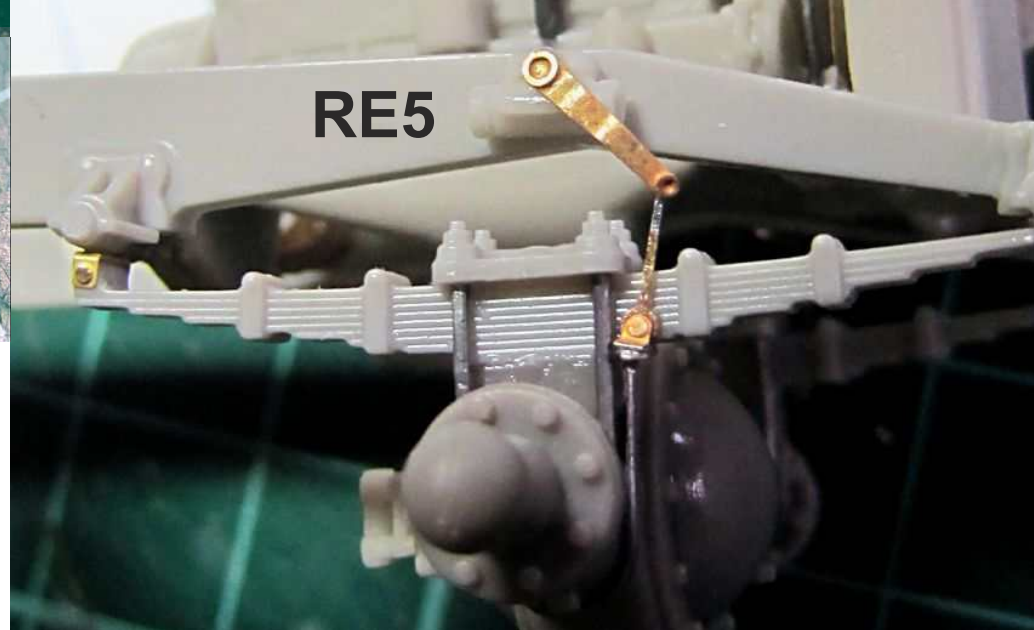
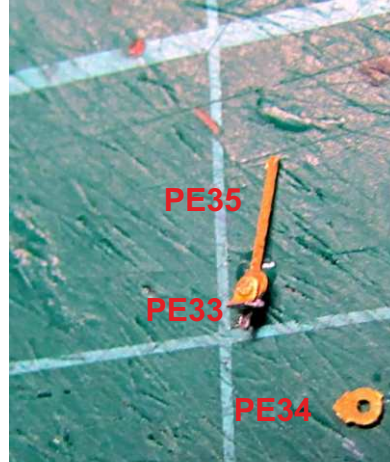

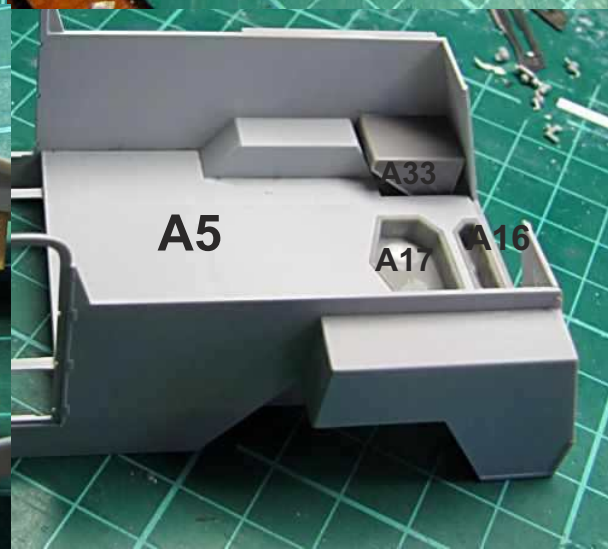
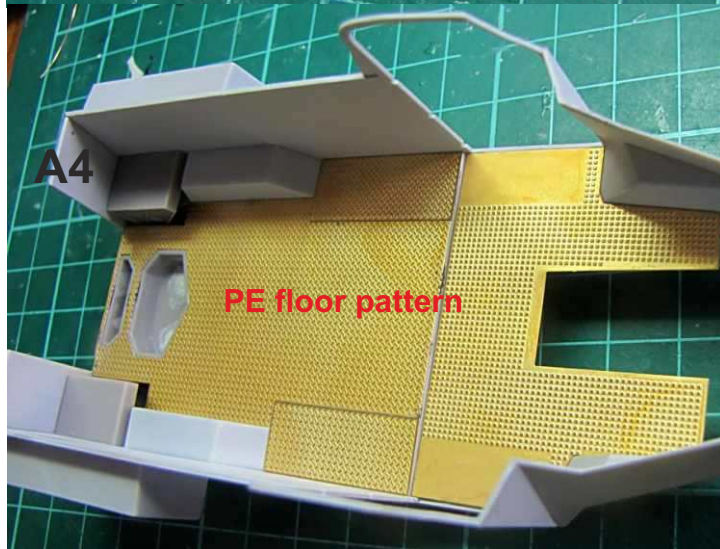
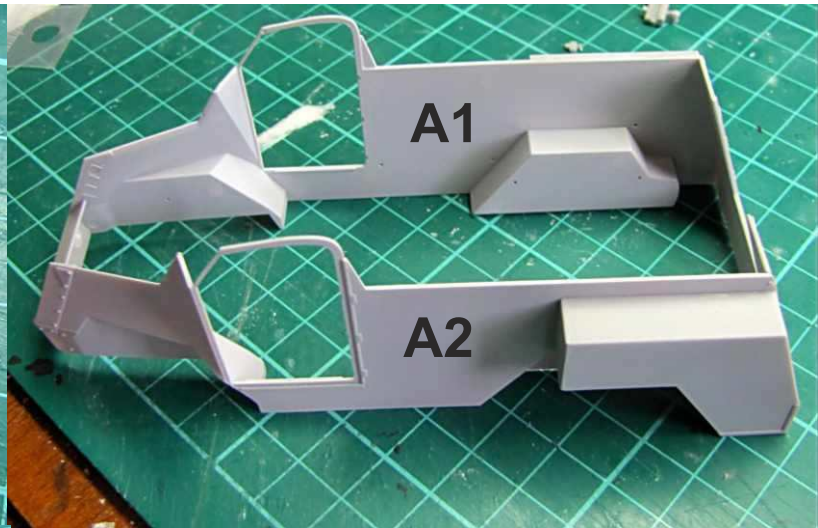
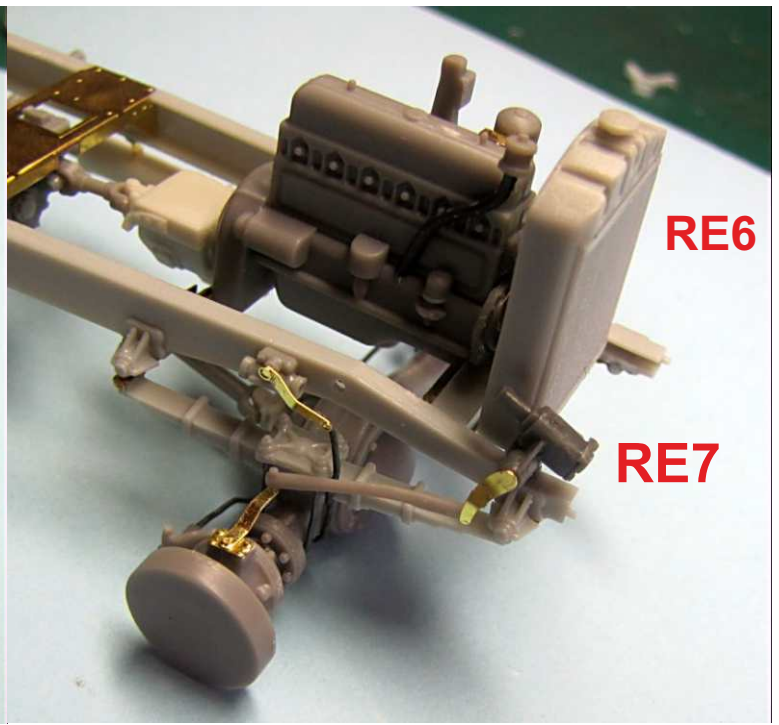
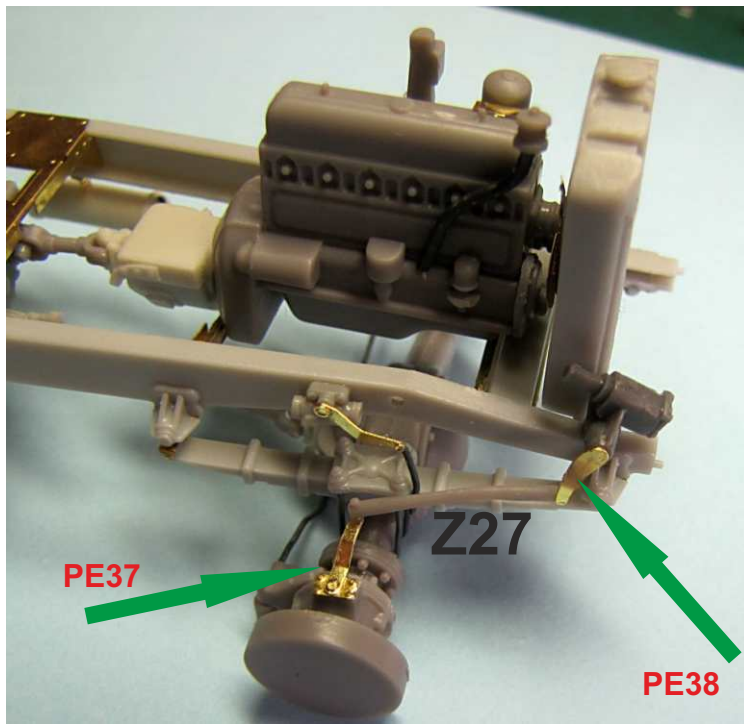

A5 and A33 pins on them into holes in sides top edge of A16 and A17 0,3mm below floor level

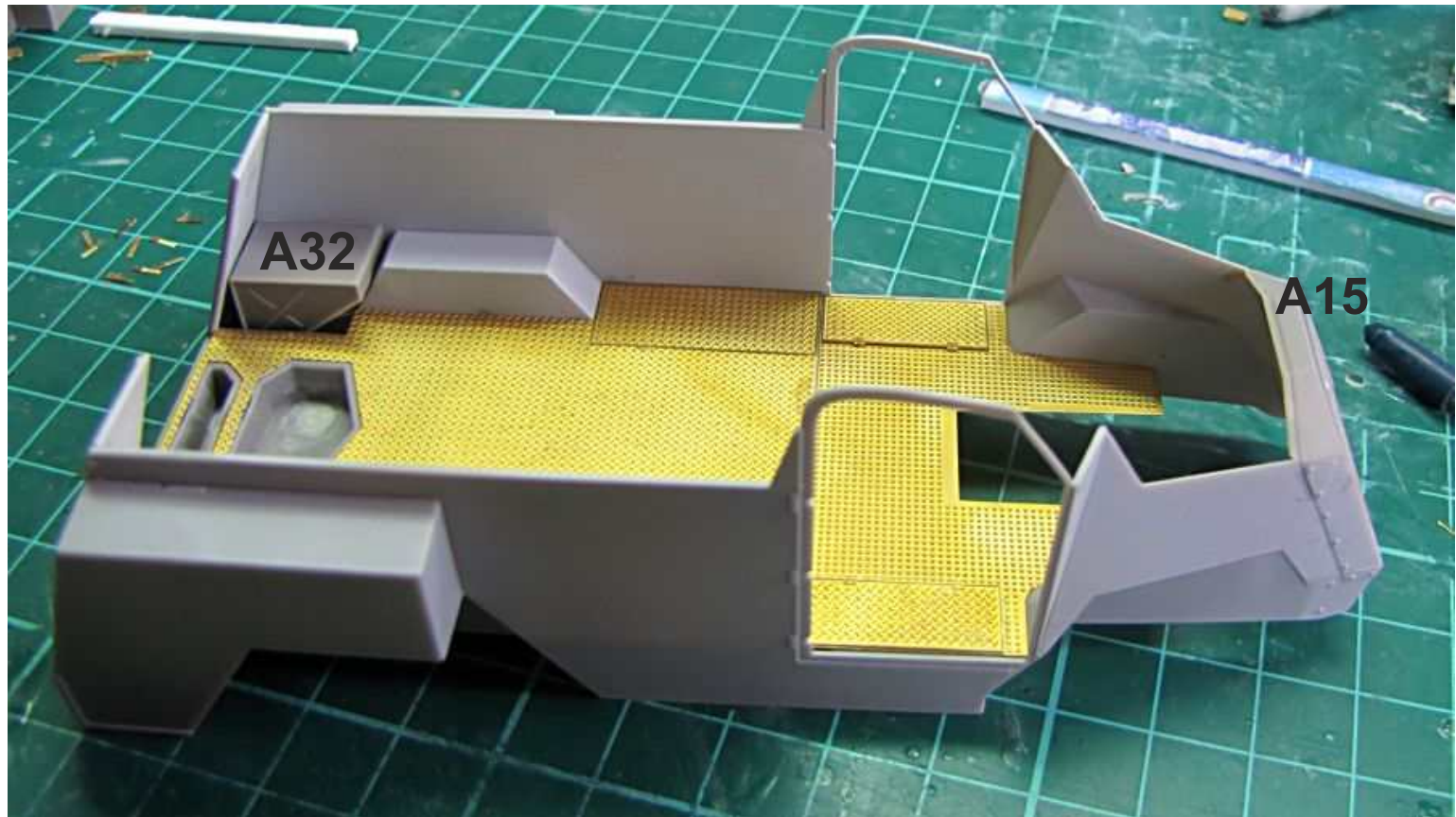

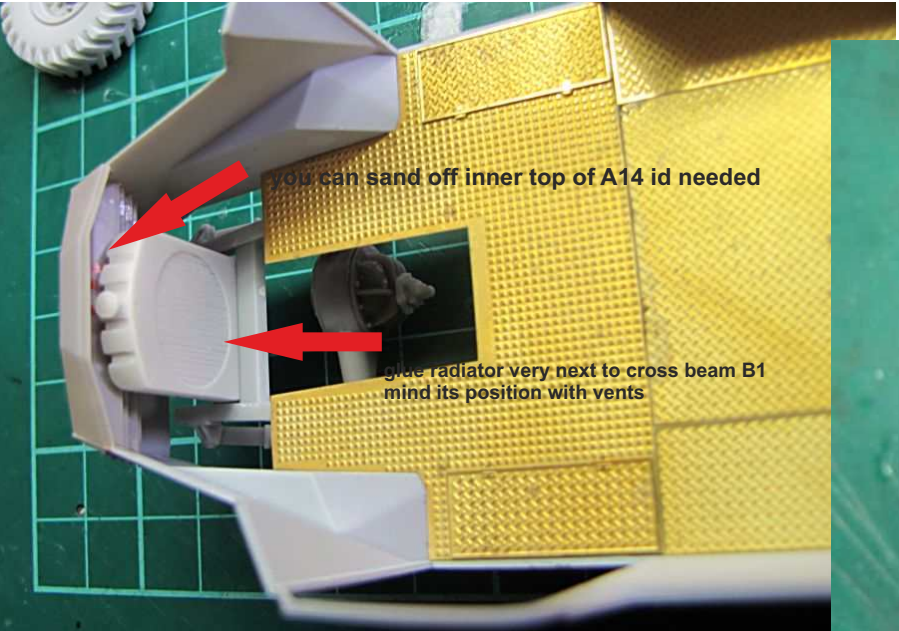
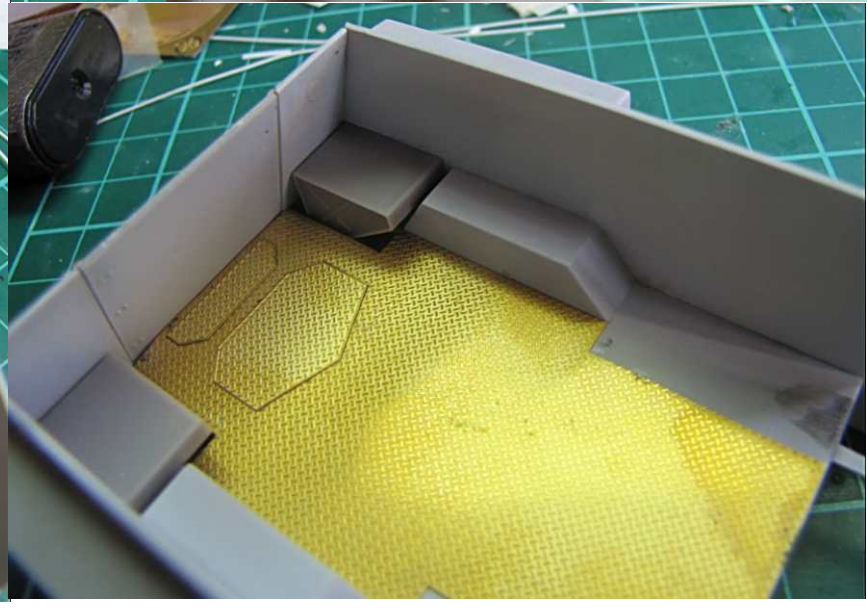
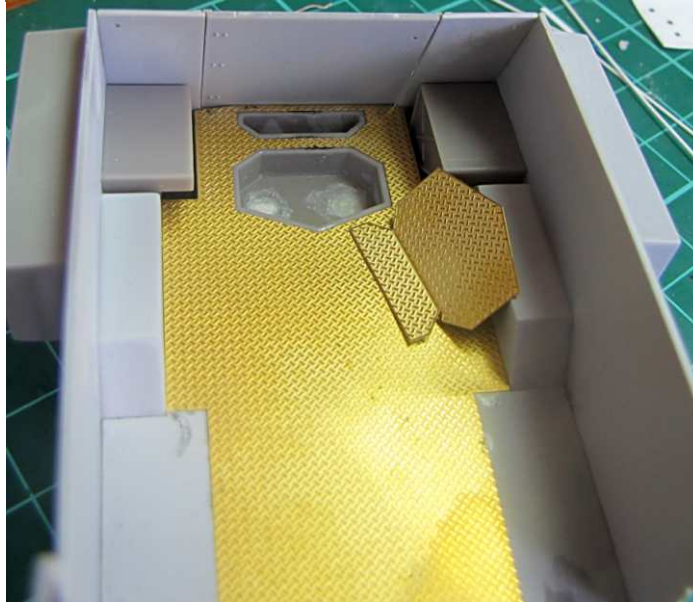
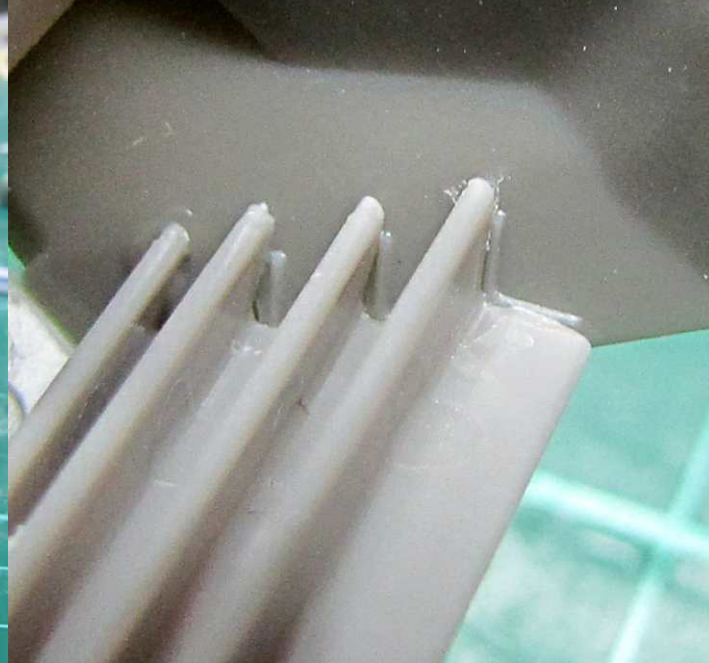

You can sand off inner top of A14 id needed

glue radiator very next to cross beam B1
mind its position with vents

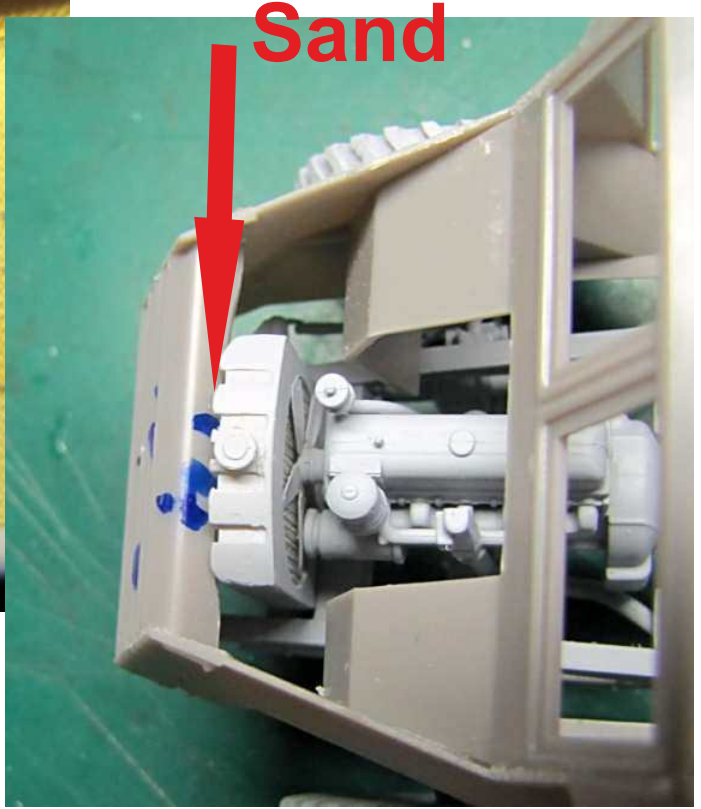

Sand

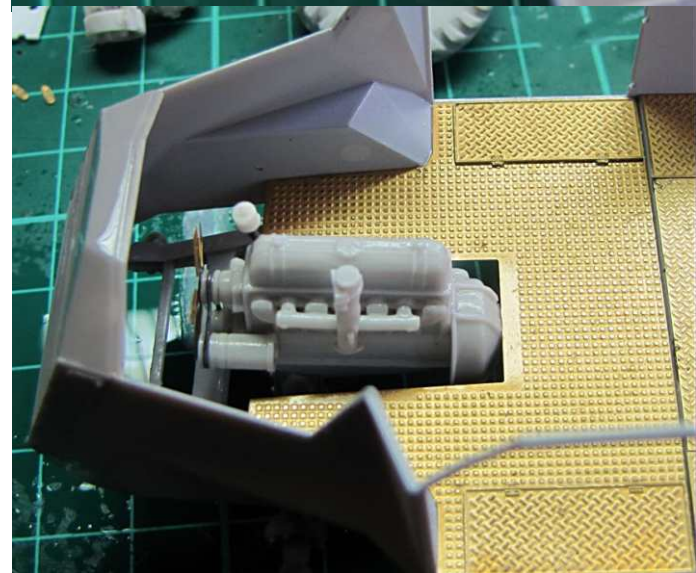
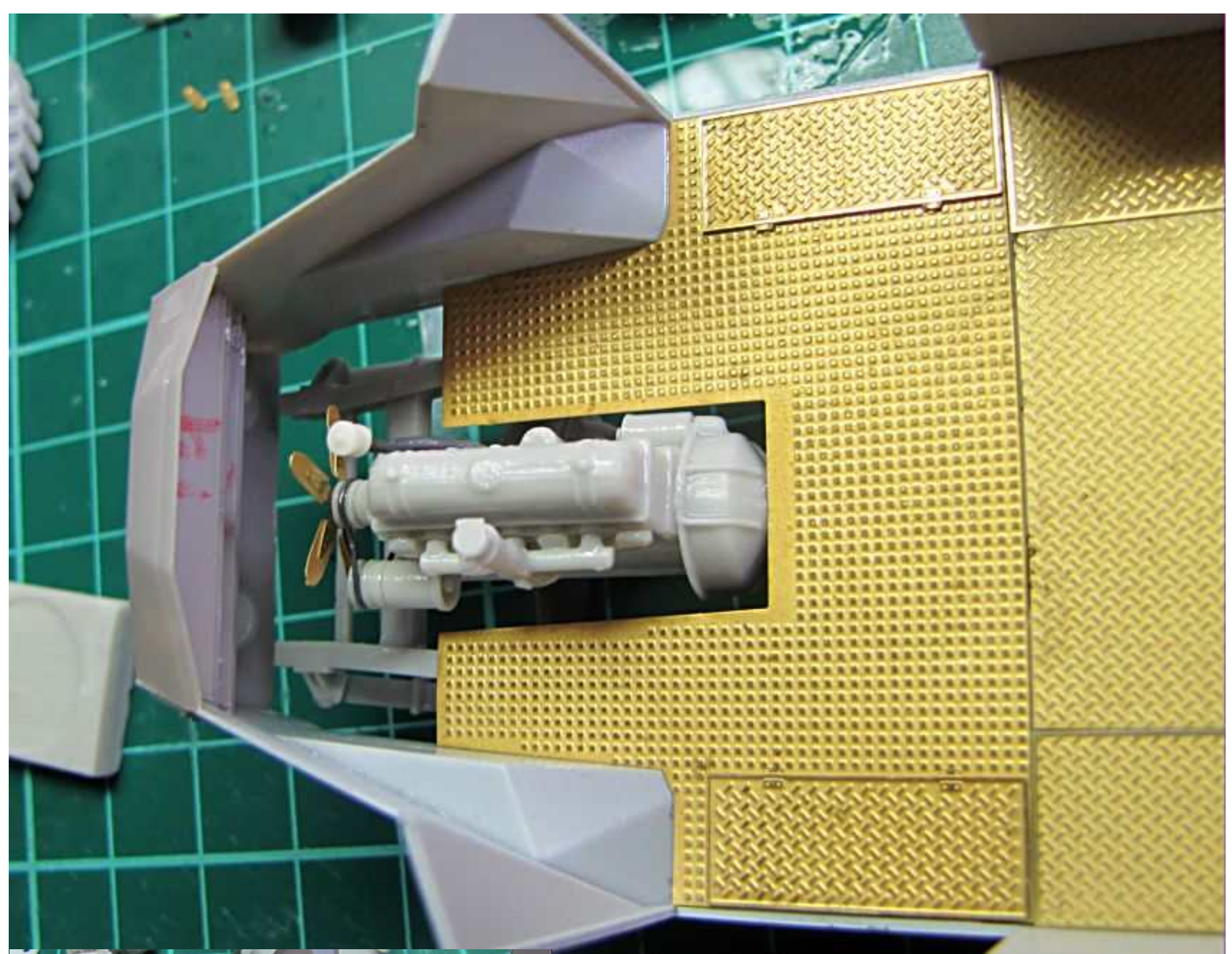

The kit offers option of closed or open front windows, but because of difference between wall thickness in real and scale, it is only possible with a little surgery. **If you want to build closed vehicle without interior details, you can leave these steps**

A48 - mind inner and outer design

glue on 2 plastic strips (supplied in bag) 0,75x1,6mm, 0,2mm thick - closed window

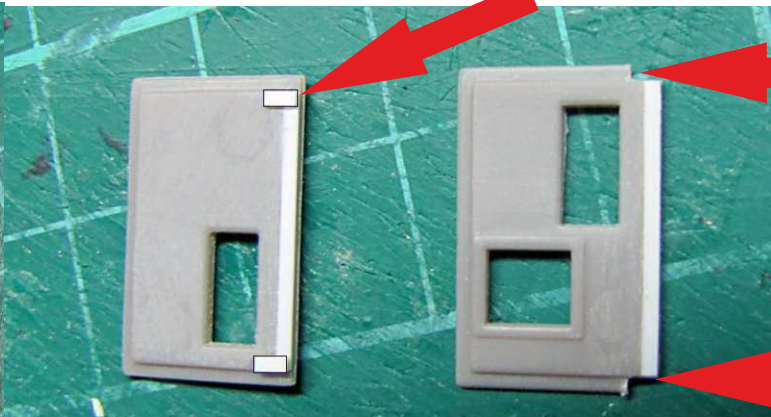
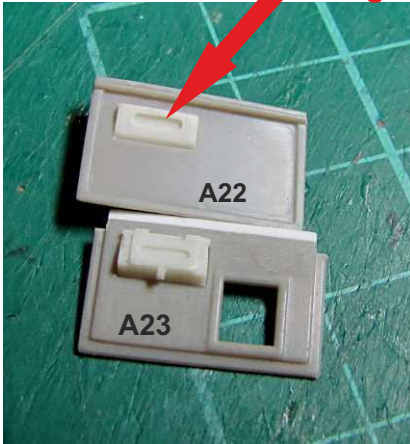

cut - sand - as shown in pictures for open window option

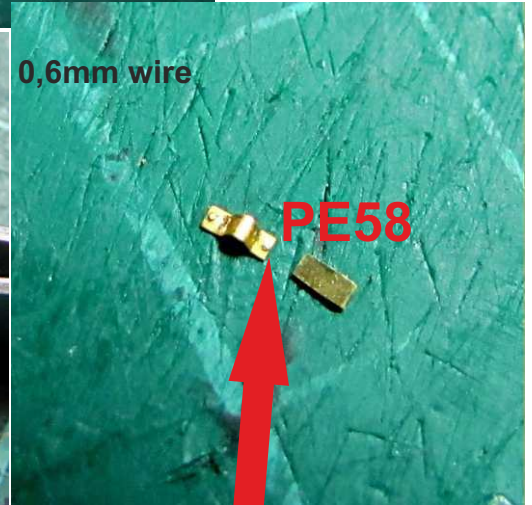

0,6mm wire

PE58

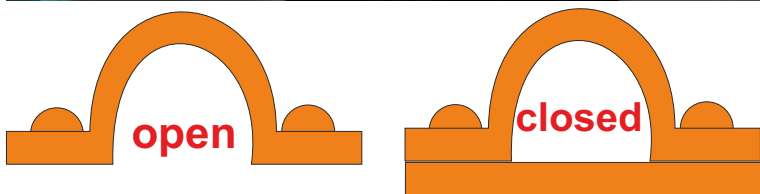

**bend base of PE14 180° below to adjust its high for closed window option
cut it out like in picture and use just part with rivets to make hinges for open window option**



small windows assembly - for closed option use PE54, for open option use PE53
mind position of PE52, different for opened (down) and closed (up) window

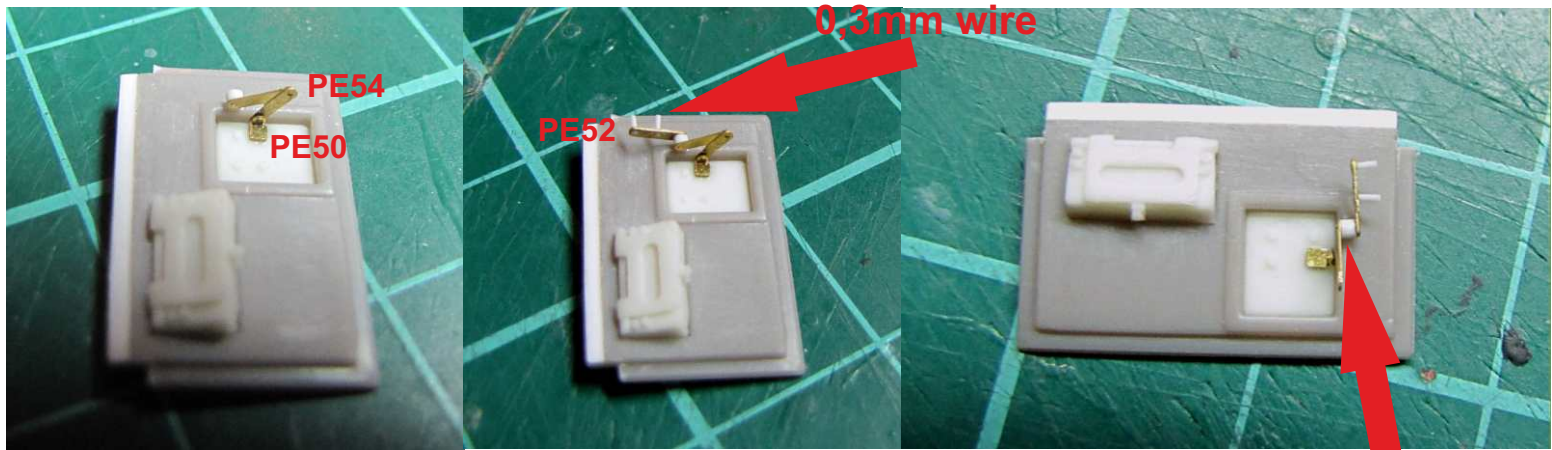

slice of plastic rod provided in the bag

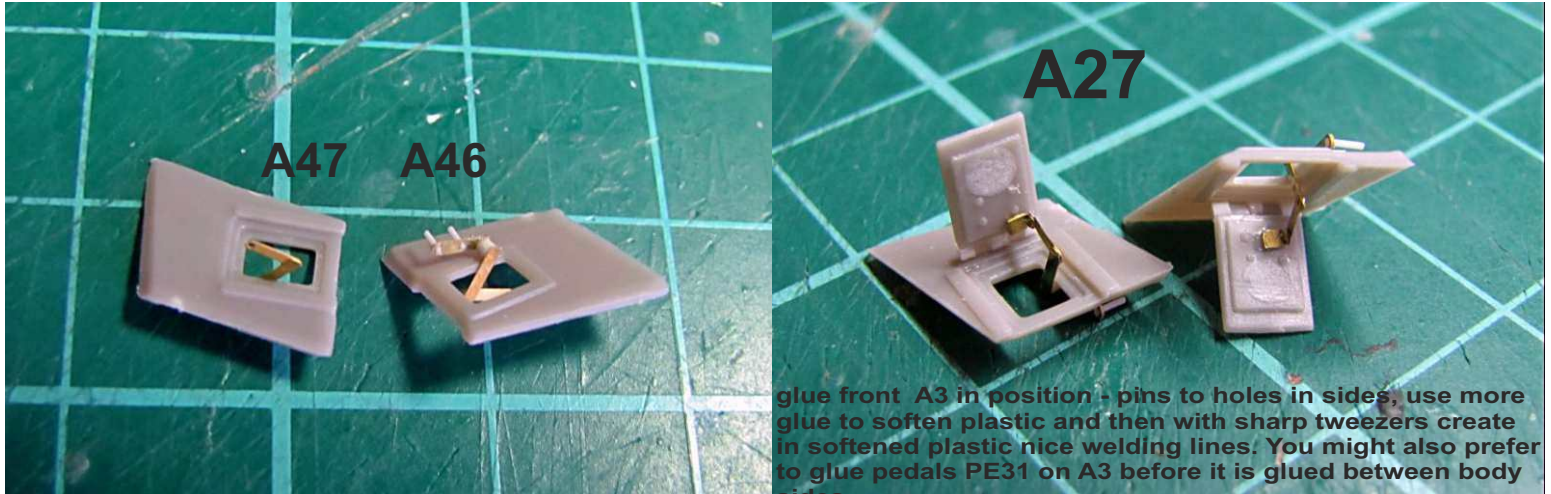
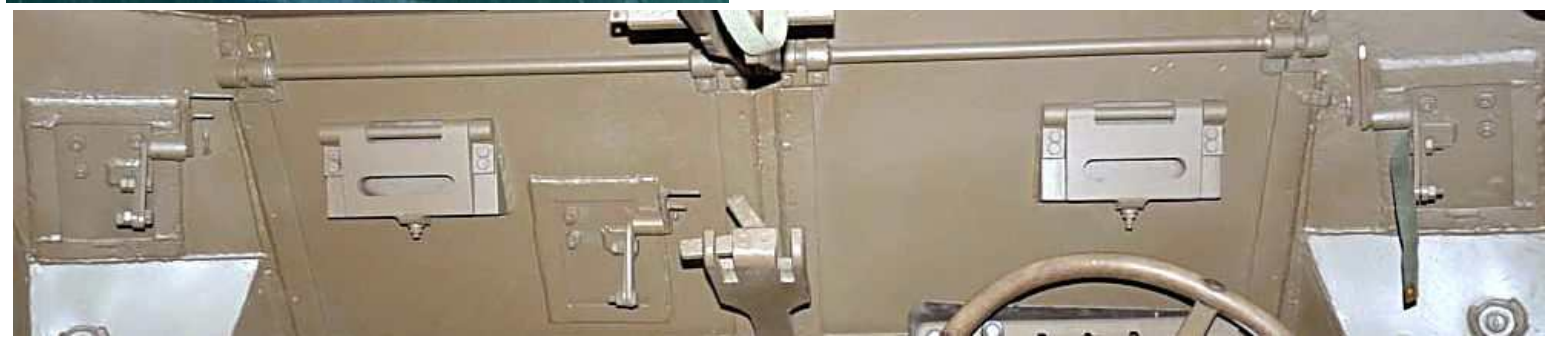

Use these parts from newly tooled sprues - they have hinges molded on

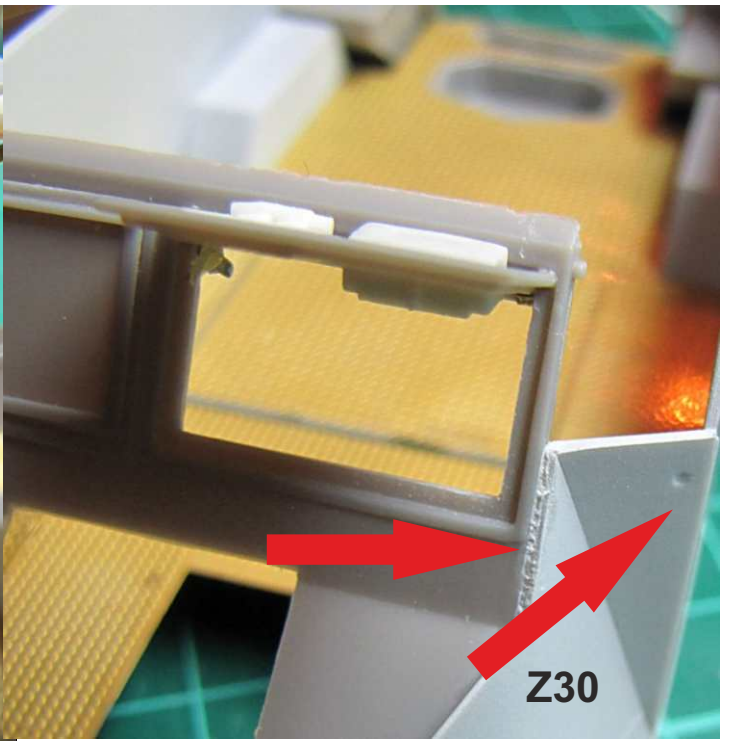
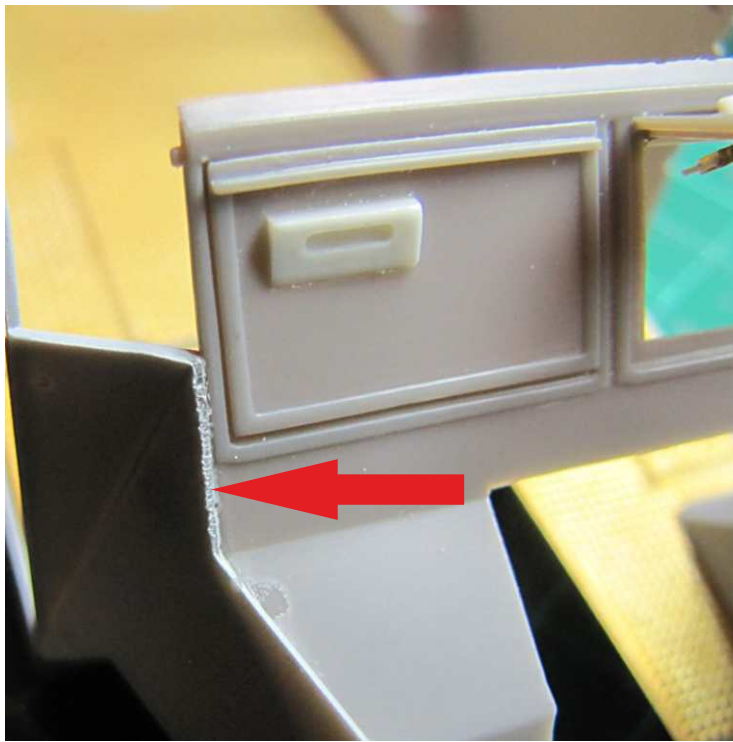

glue front **A3** in position - pins to holes in sides, use more thing glue to soften plastic and then with sharp tweezers create in softened plastic nice welding lines. You might also prefer to glue pedals **PE 65** on **A3** before it is glued between body sides. You can also drill hole 1mm between pedals for steering wheel's rod

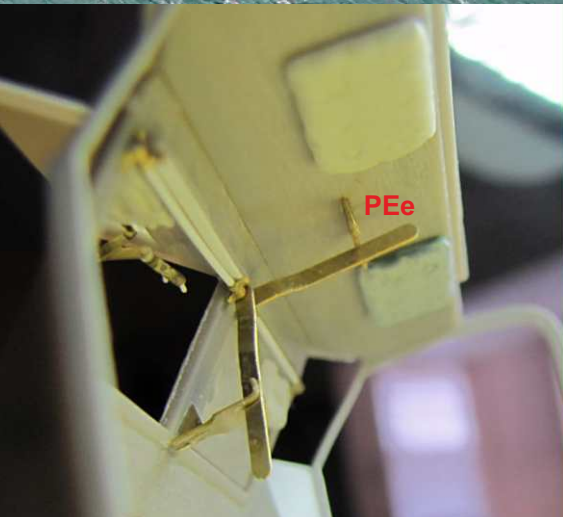
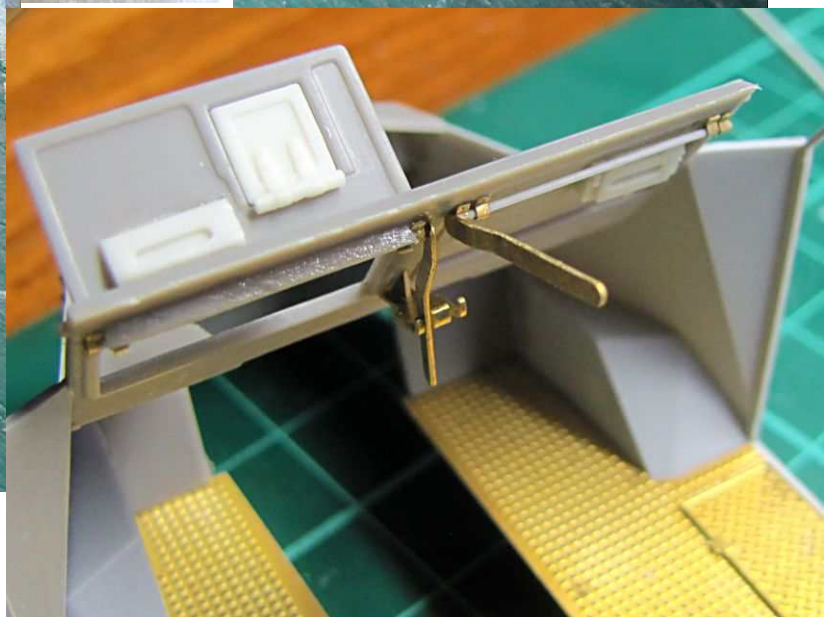
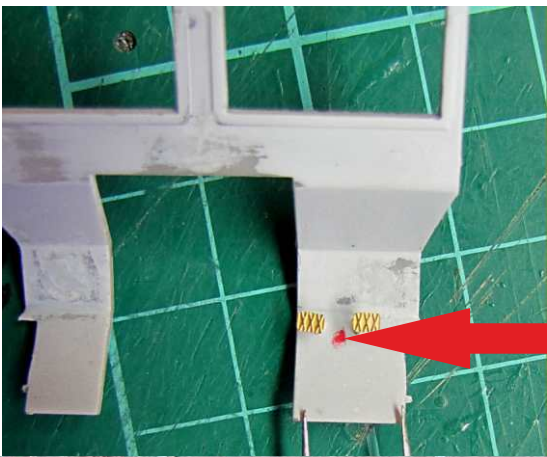

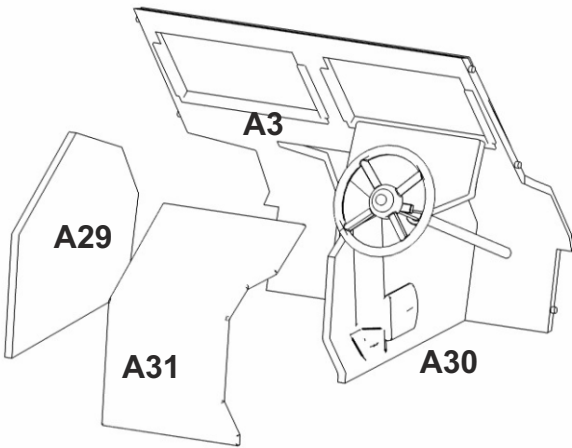
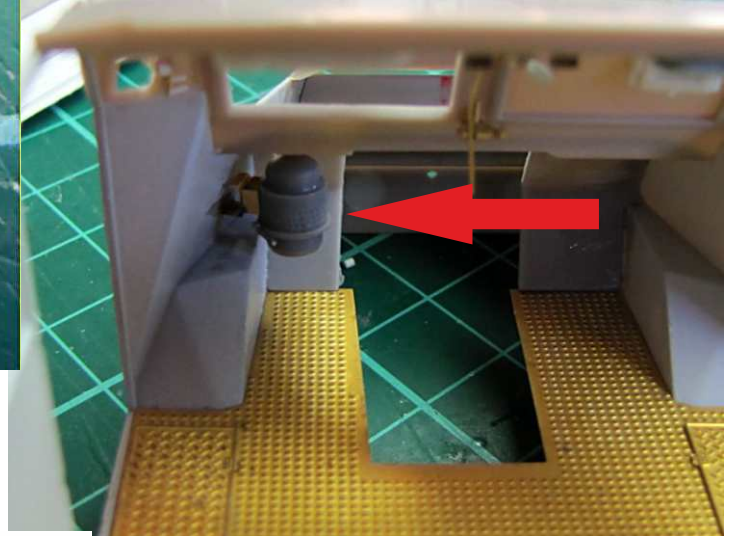
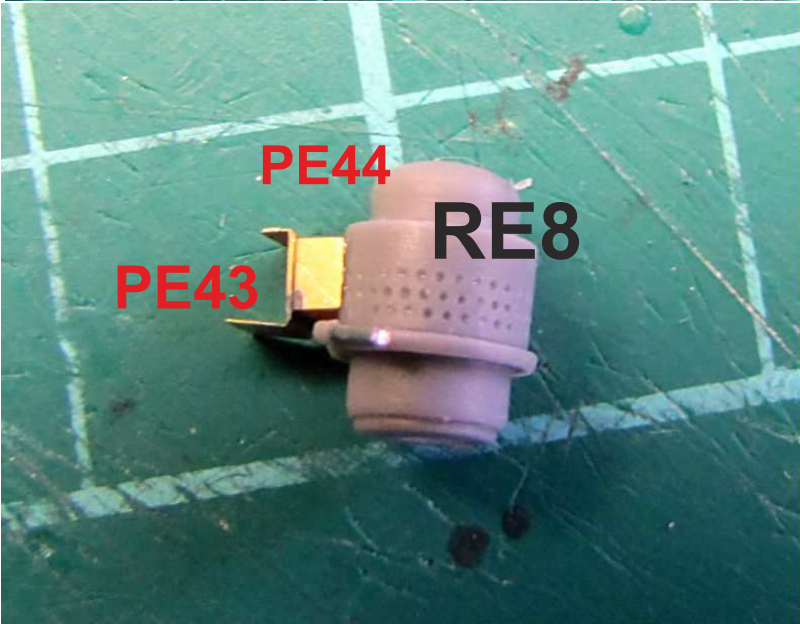

Assemble dog house and steering wheel

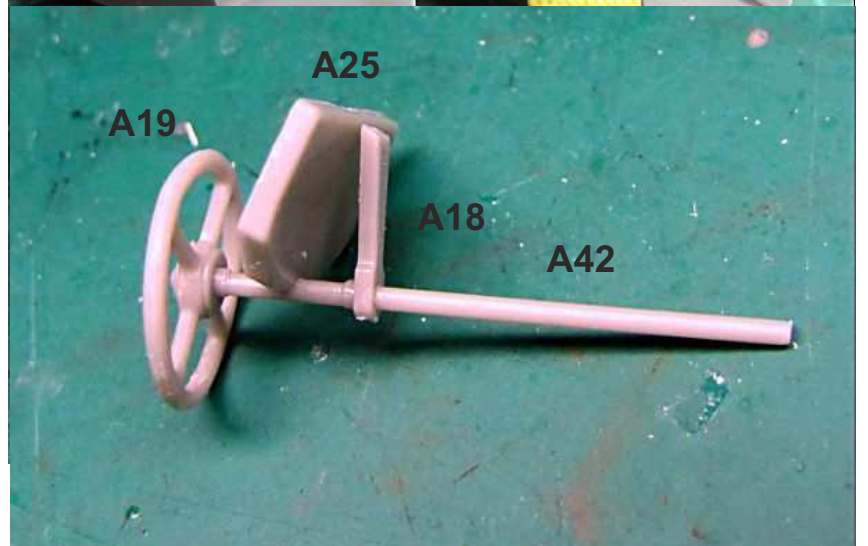

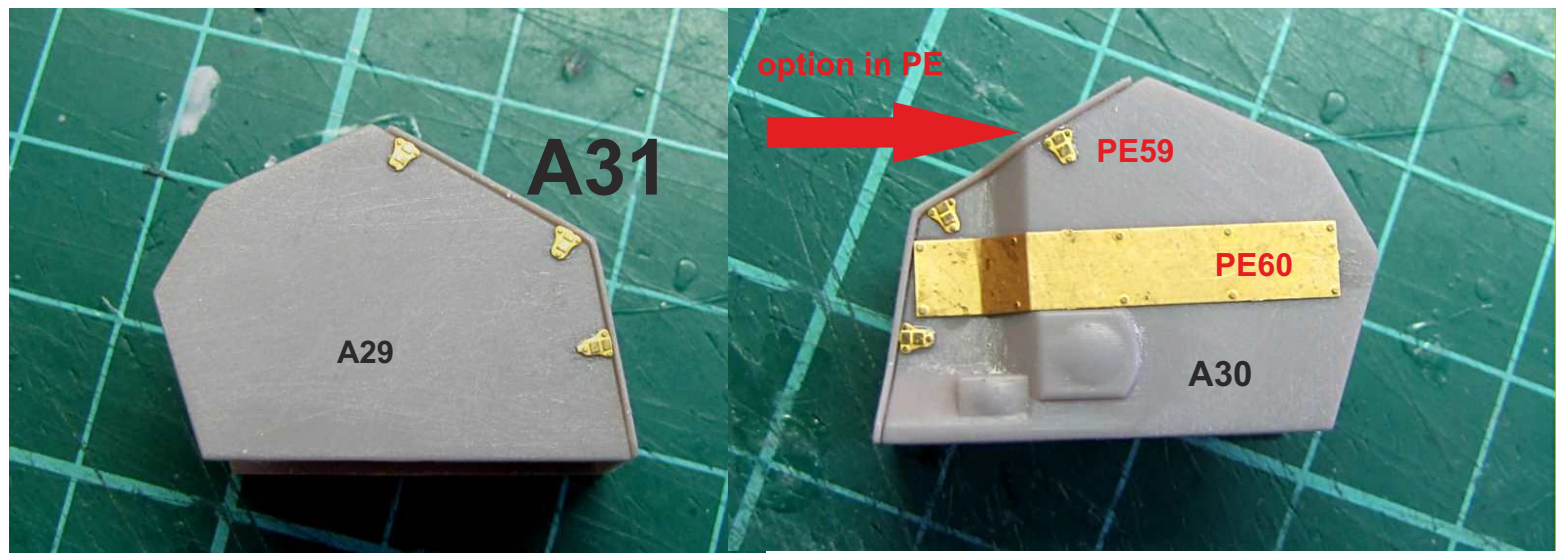

A31 can be replaced by PE cover from small PE sheet with hinges

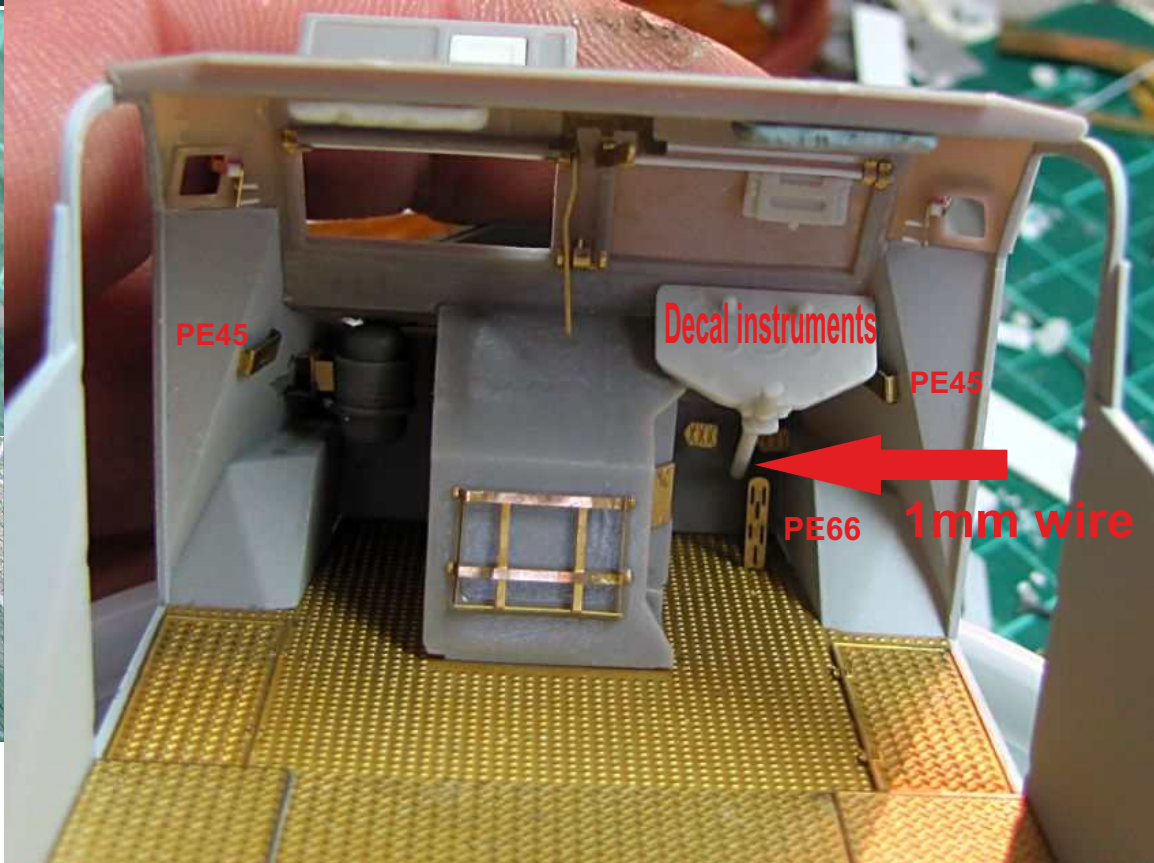
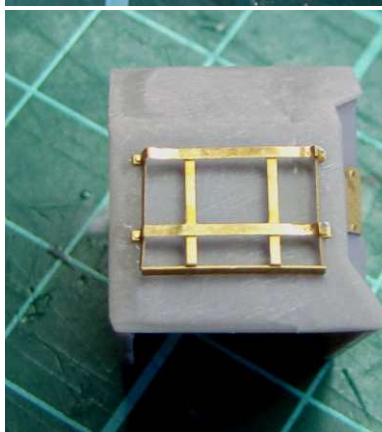
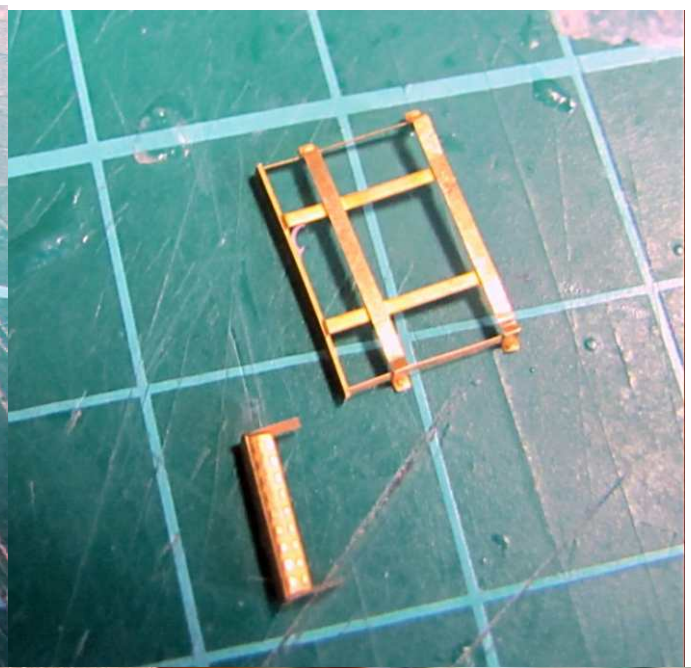
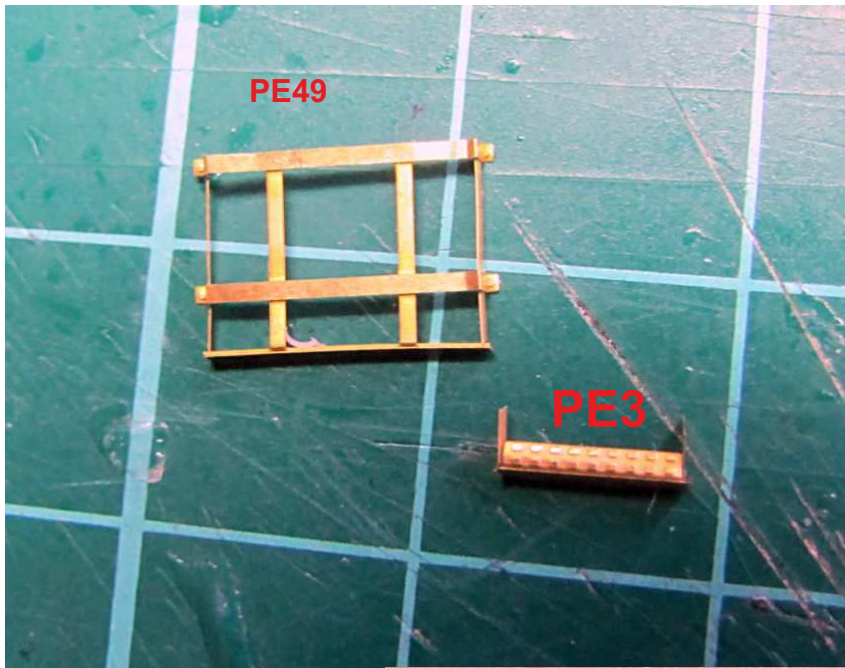

Making the door hinges in this kit. There are two option to make hinges, we have retooled most of parts with hinges molded except the body parts.

Now there are two possibilities - in bag are included two clear plastic rods C4-1, C4-2, which can be sliced to single bits, and these glued on sides of middle hinge molded on doors and windows. More effort will need making the hinges of PE bits and wire provided, but it will create the best result.



PE hinges

rod slices glued on door middle hinge, smaller diameter between bits left at its end will make "pin alike" look



PE05 for all dors and side windows

Fold PE bits around 0,6mm wire as shown in pictures, cut out wire in between and glue hinges in position



Front

Back

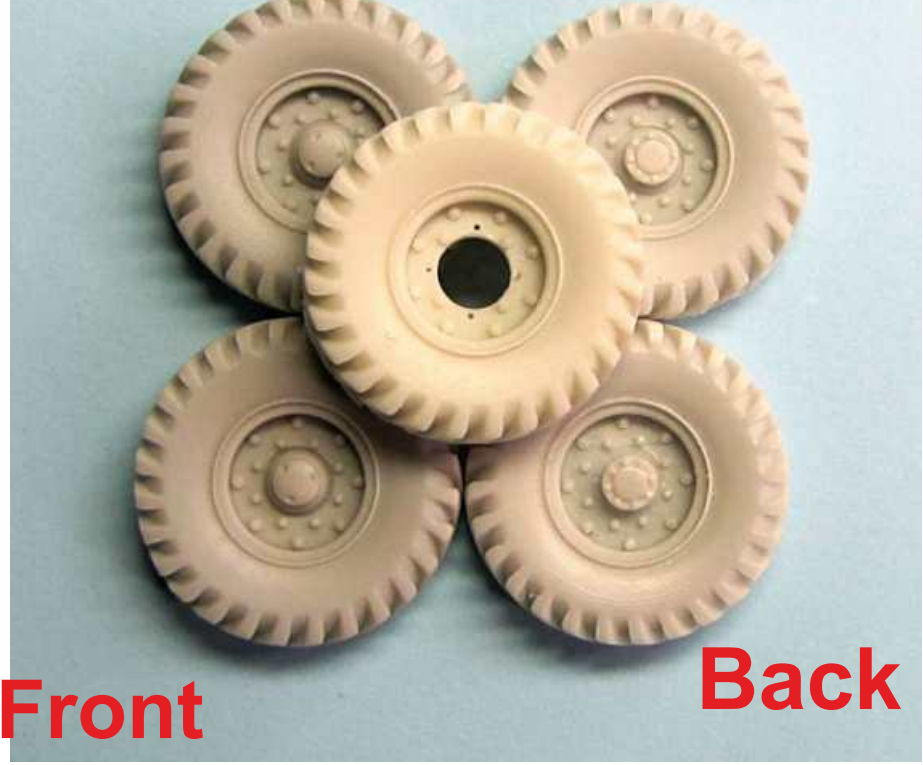

Front

Back

Assemble wheels

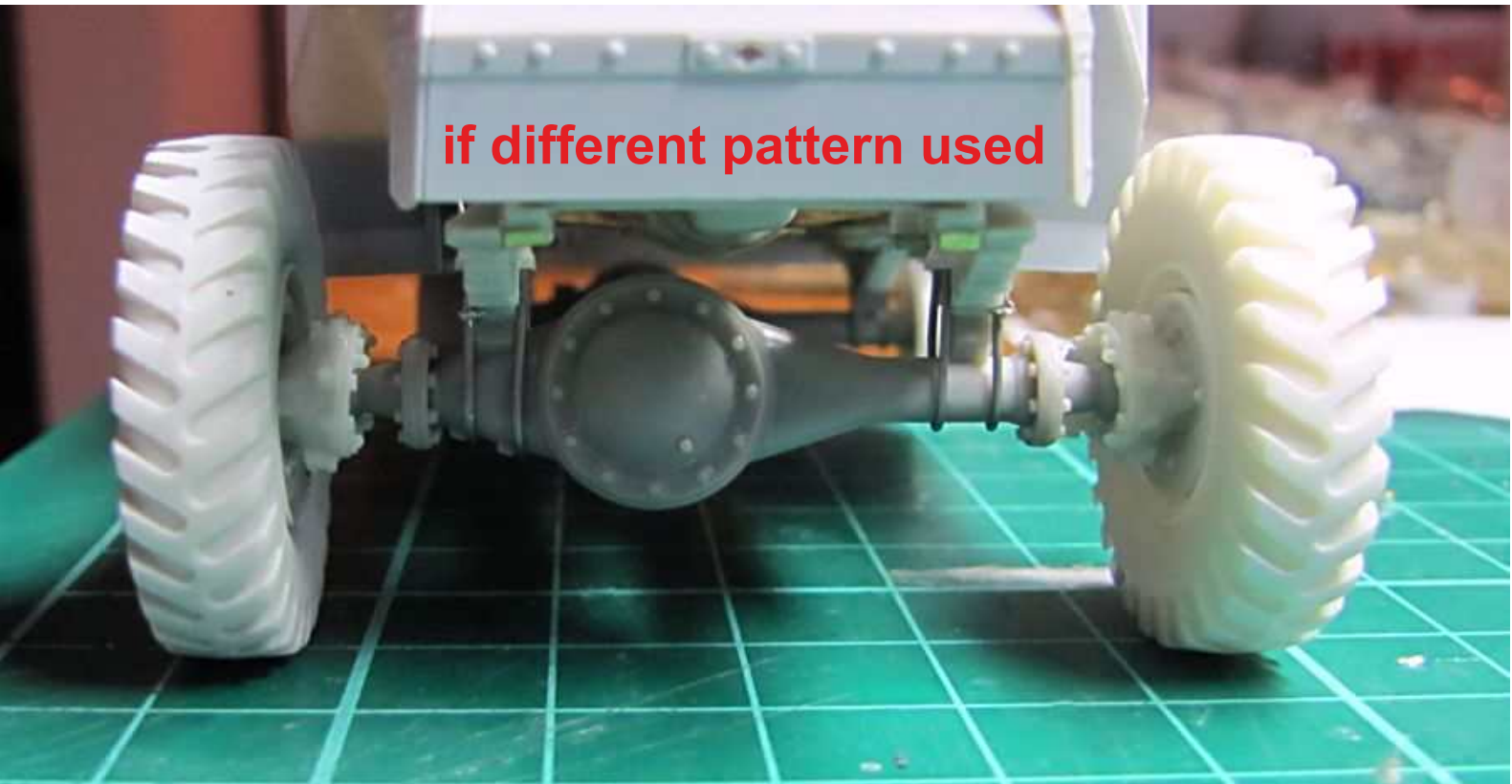

if different pattern used

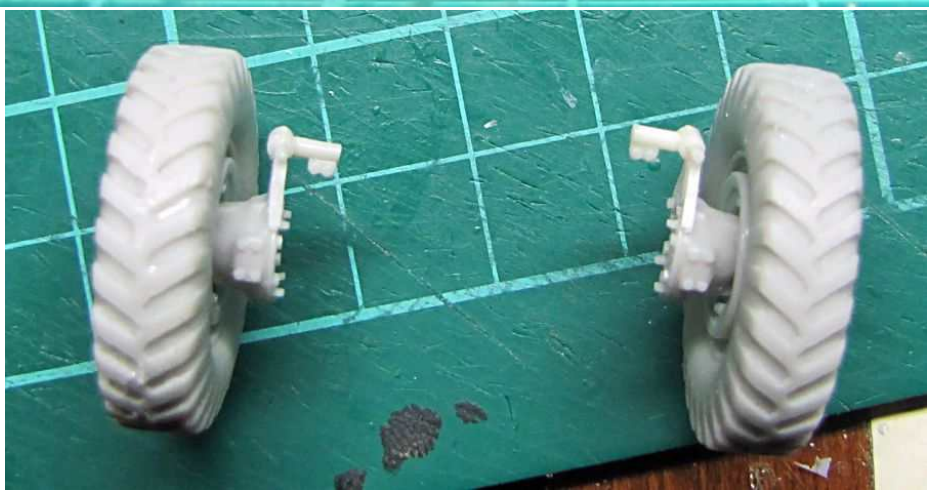

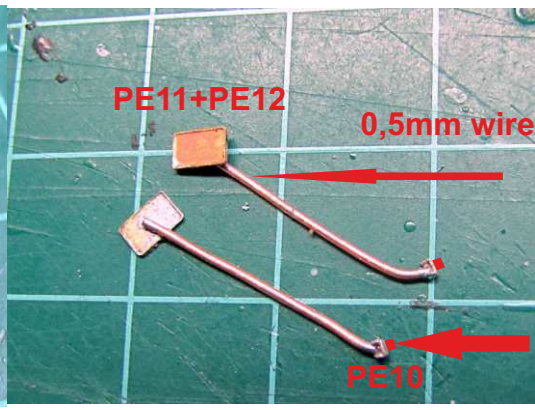

put wire through hole in PE10, leaving short end at the back, that can be glued into a hole drilled in place where mirrors are to be assembled later - your mirrors will never fall off

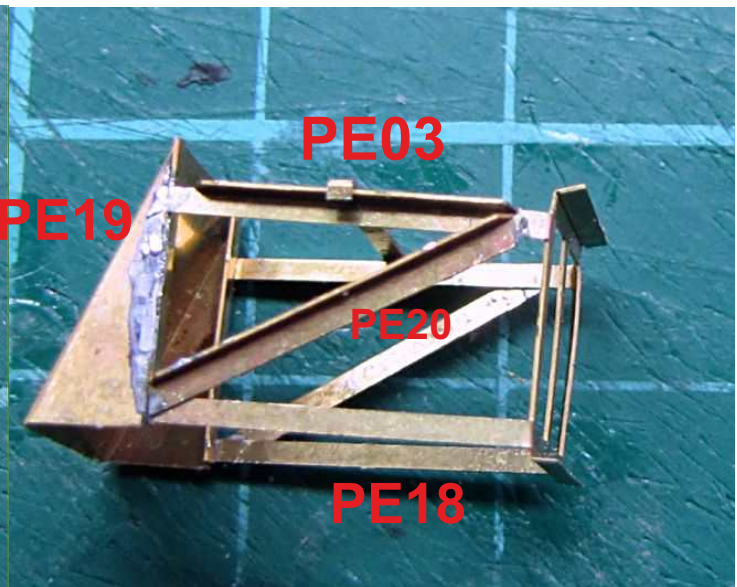
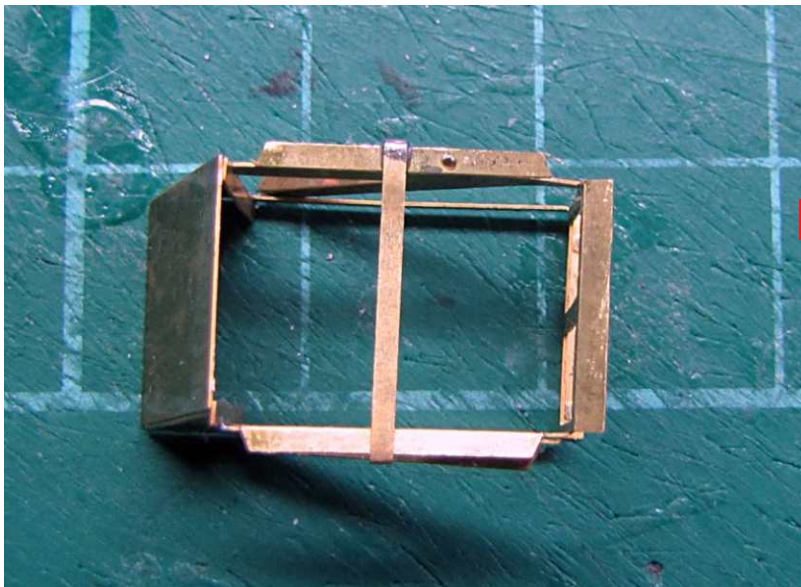

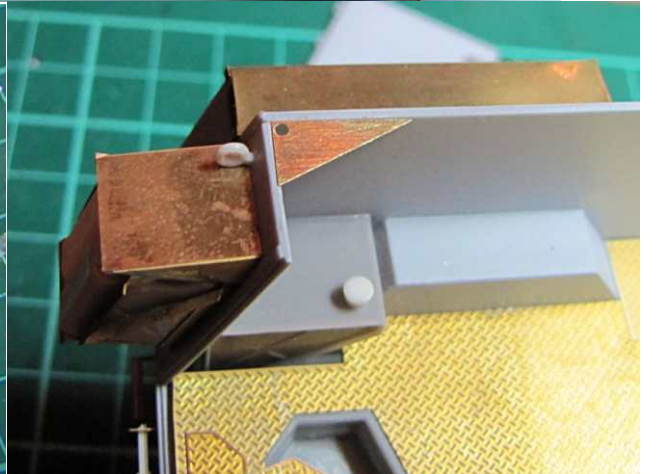
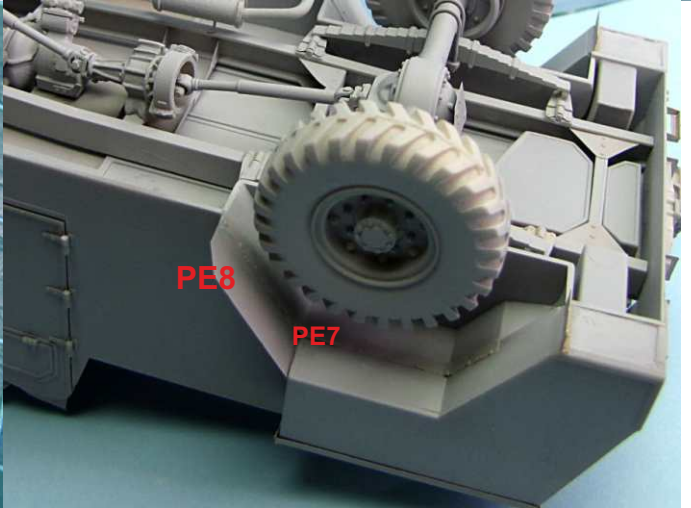
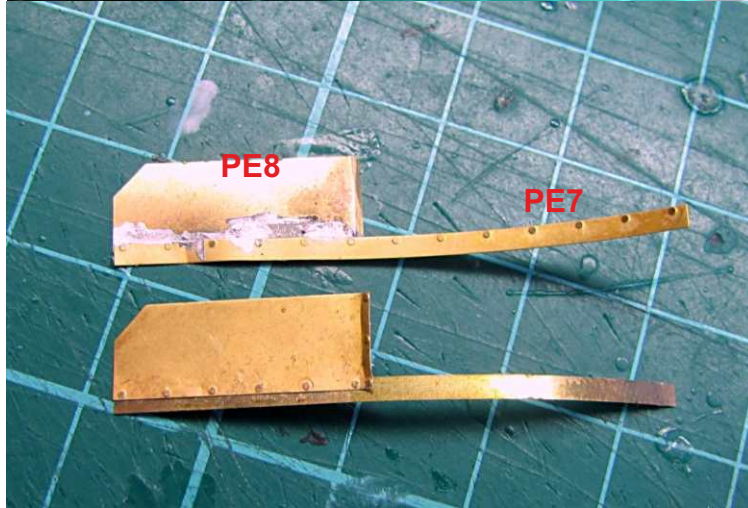
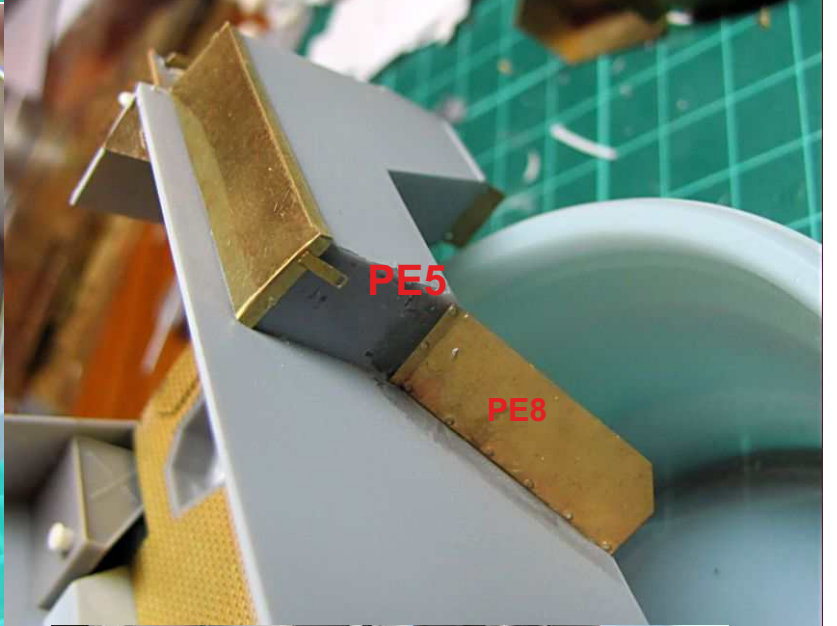
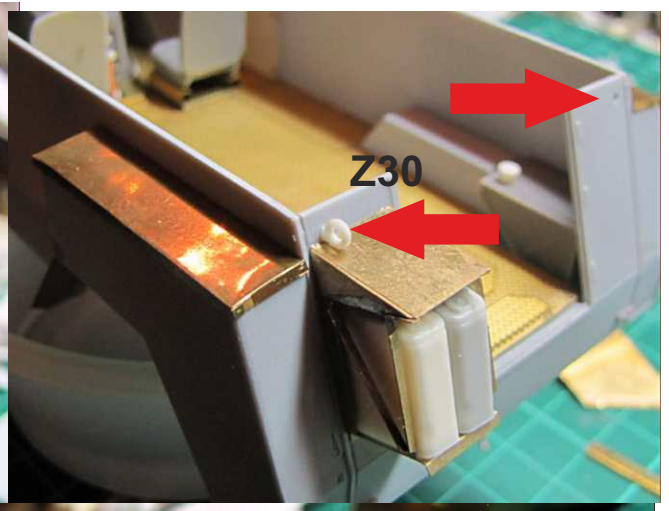
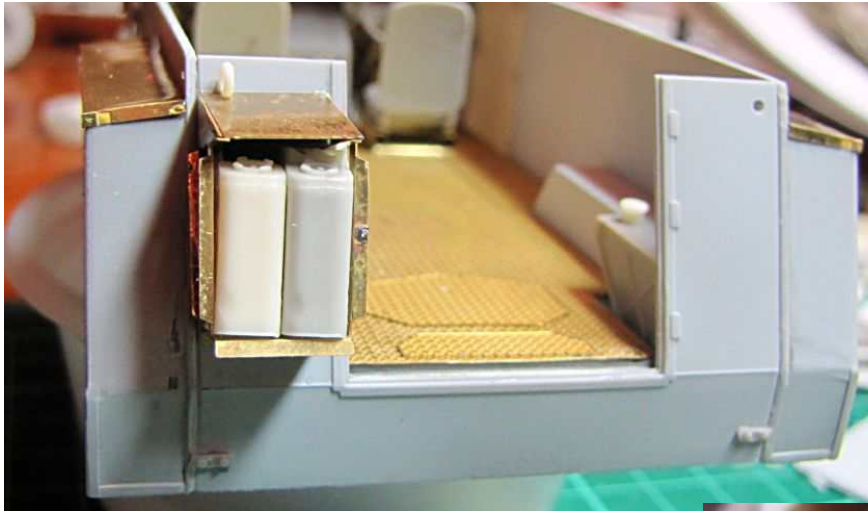

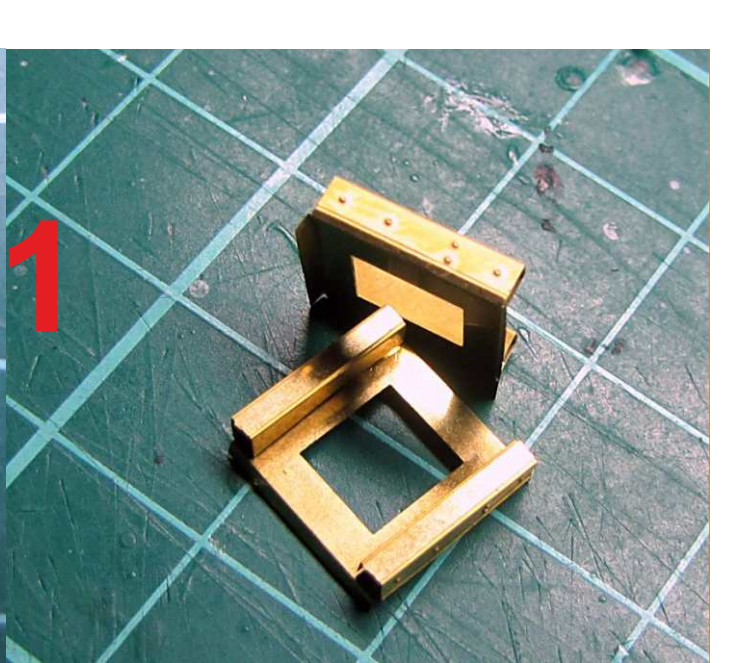
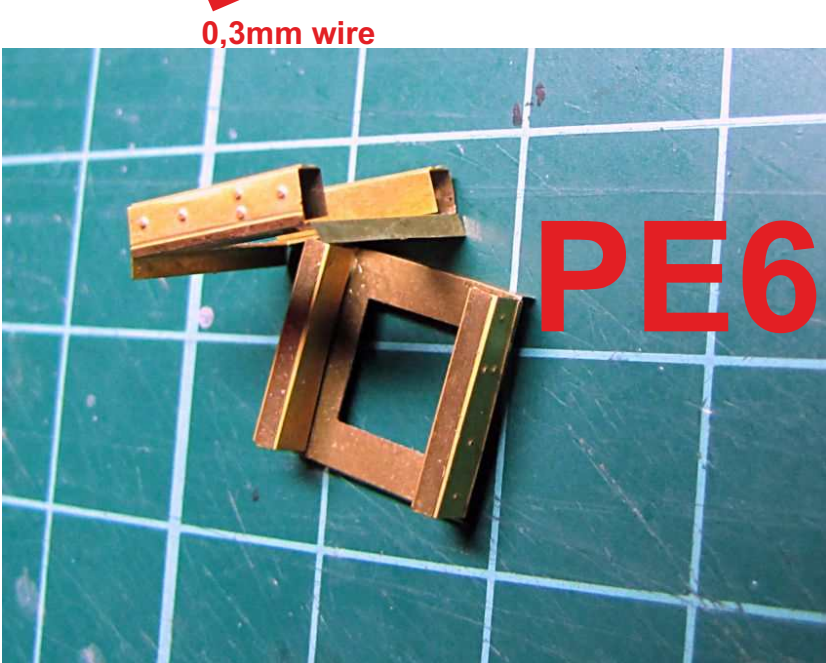
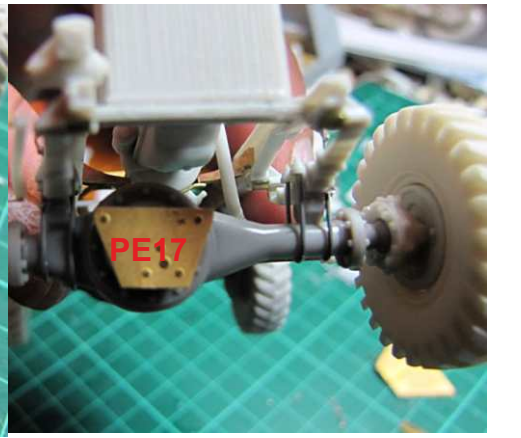
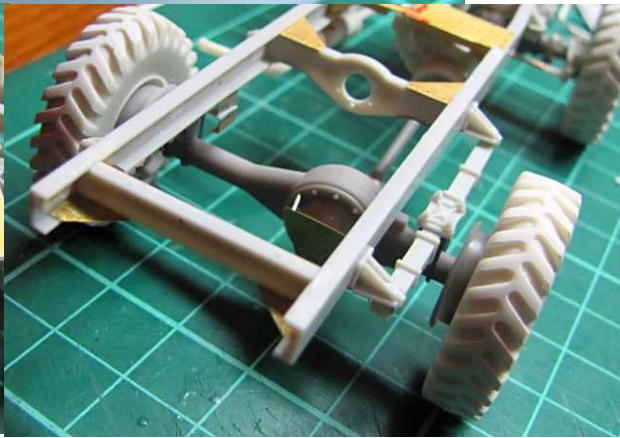
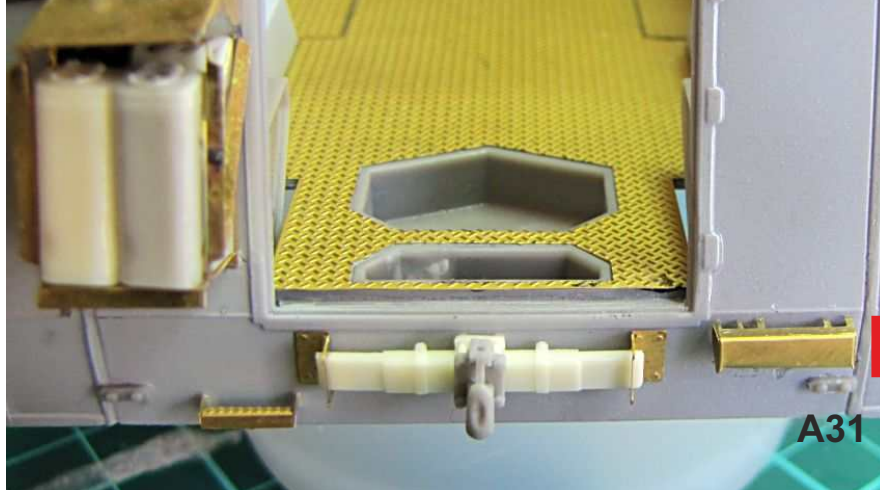
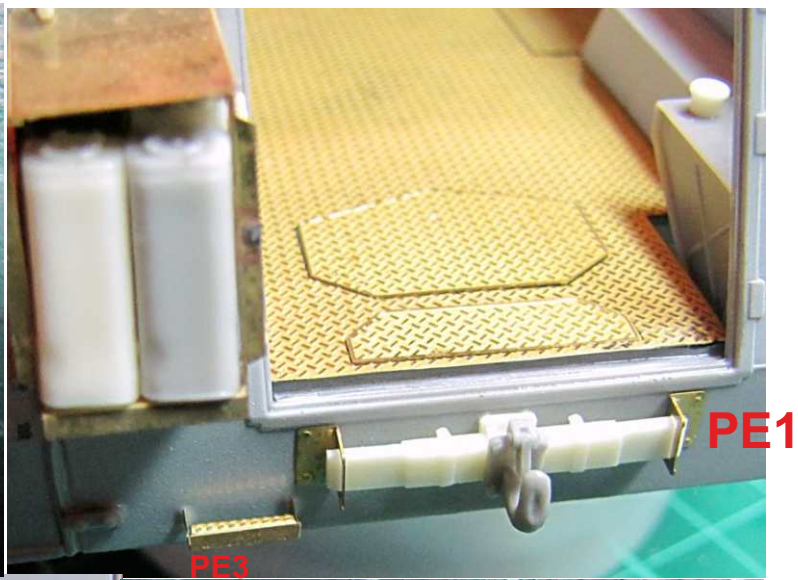

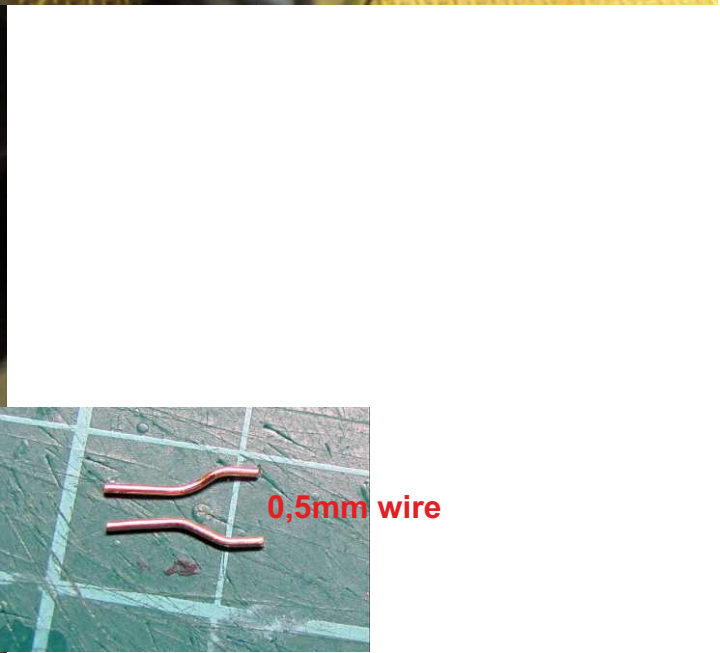
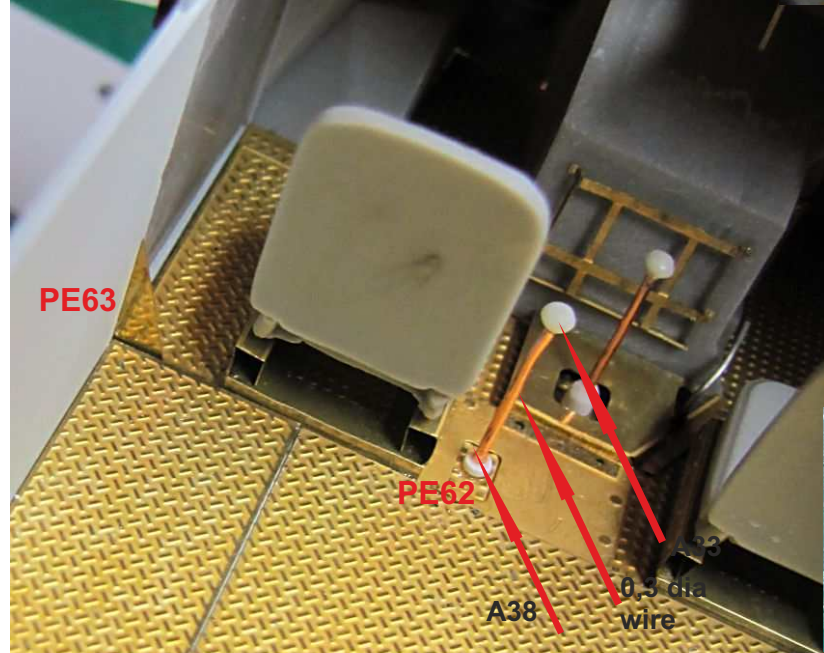
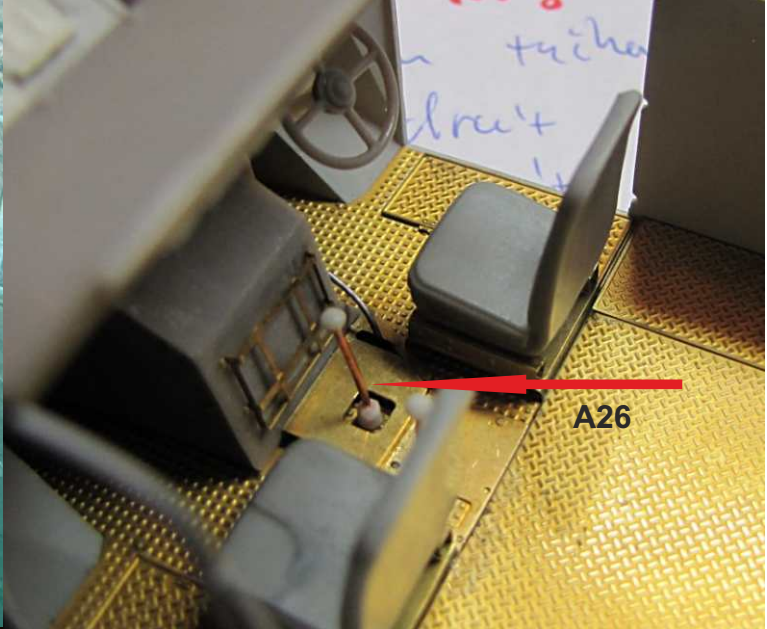

open or closed window option



4 PE handles located on C15TA-2 sheet, next to PE24
Inner PE levers PE01 located on small PE sheet



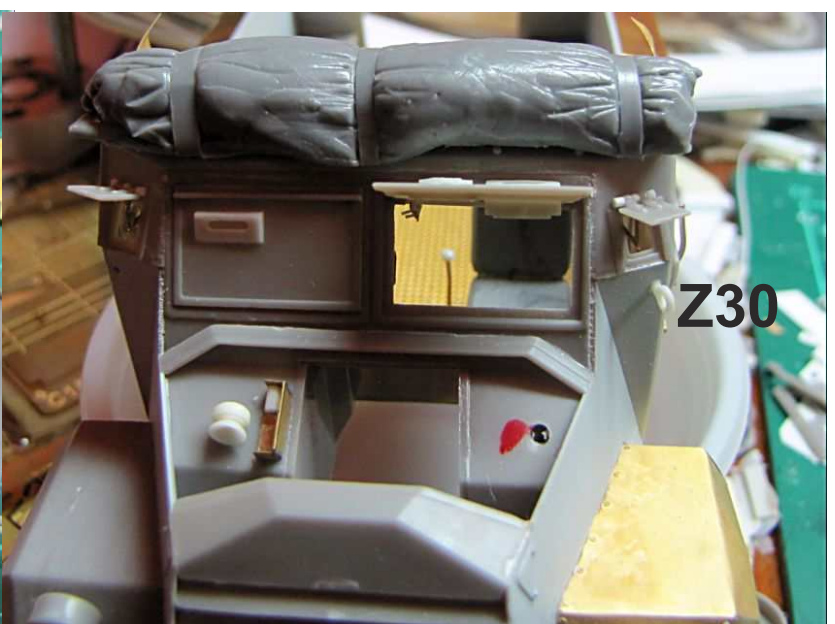

Plastic mudguards included in the kit. You can use one piece A36 ones from original sprue, or 2-piece ones from newly tolled sprue - these have better details. Upgrade PE mudguards with additional detailing PE set, stowage, tool set, glass windows assembly can be ordered from www.Lzmodels.com

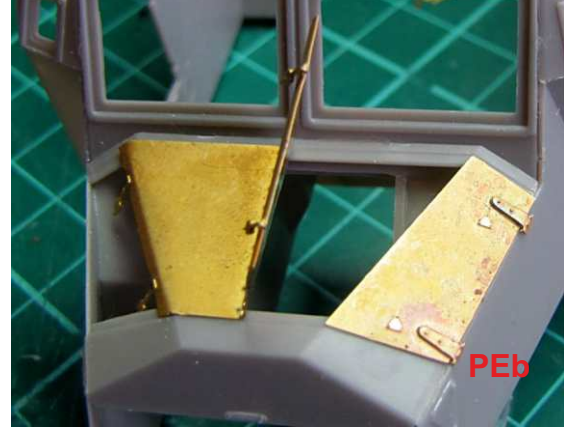
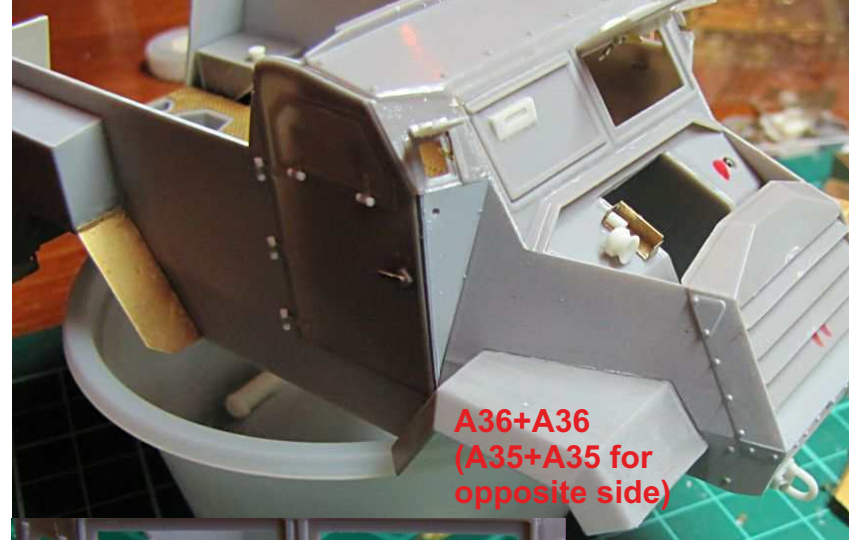

Bonnet can be assembled in any position wanted, open or closed

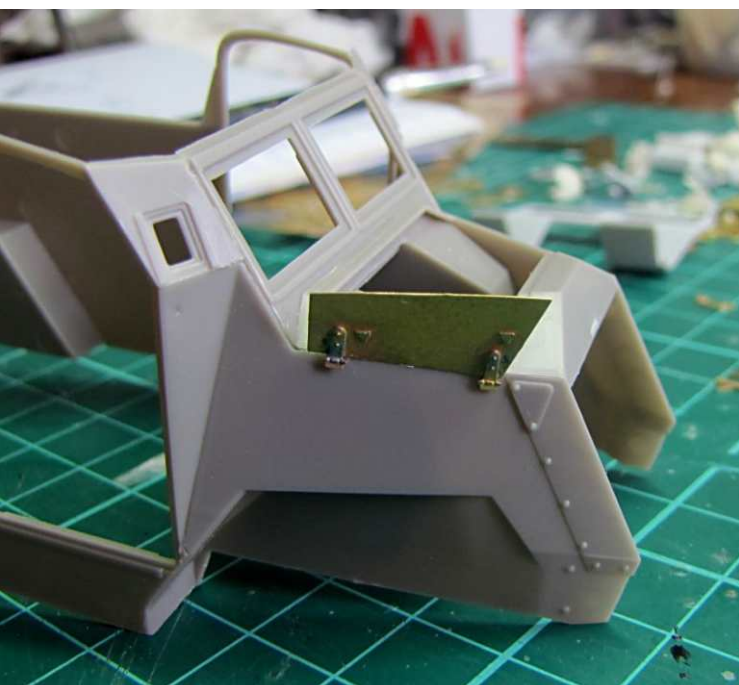

now assemble carefully body on the chassis

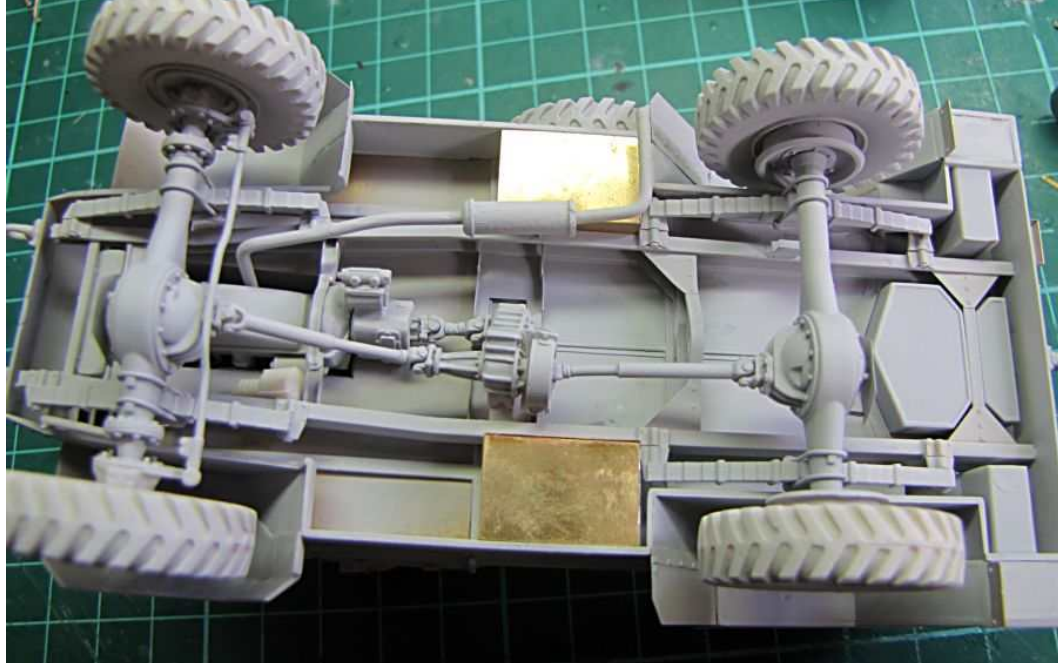
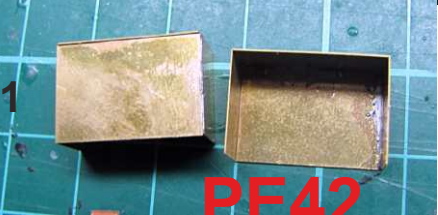
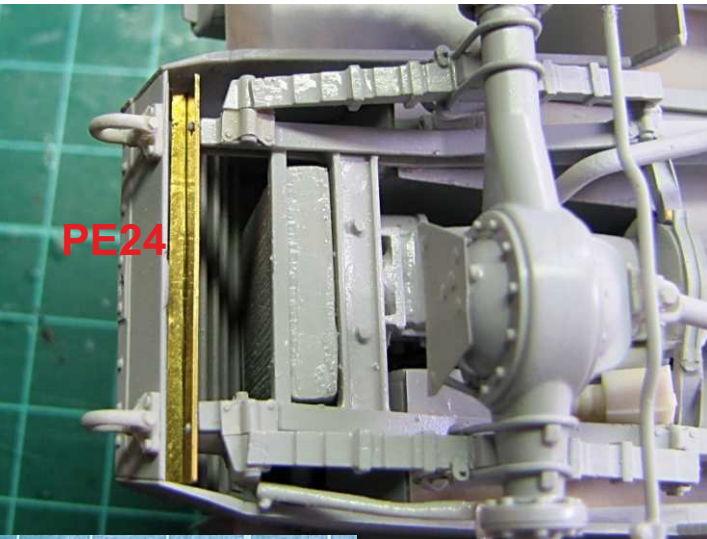

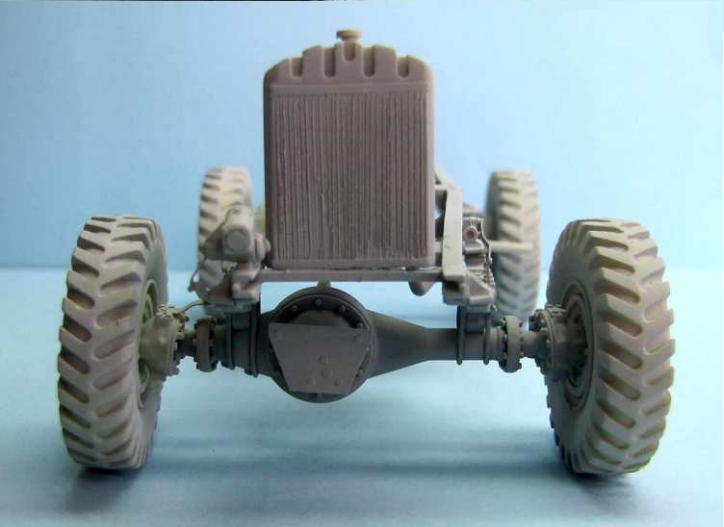
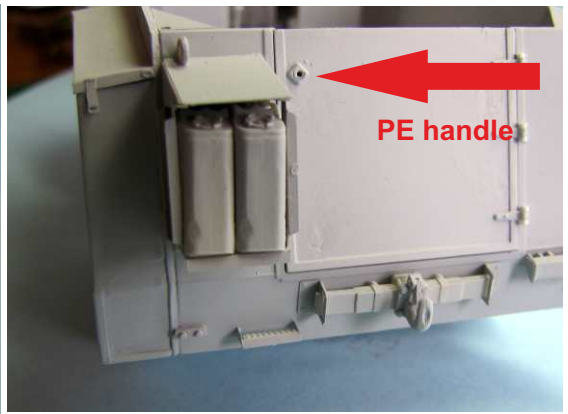
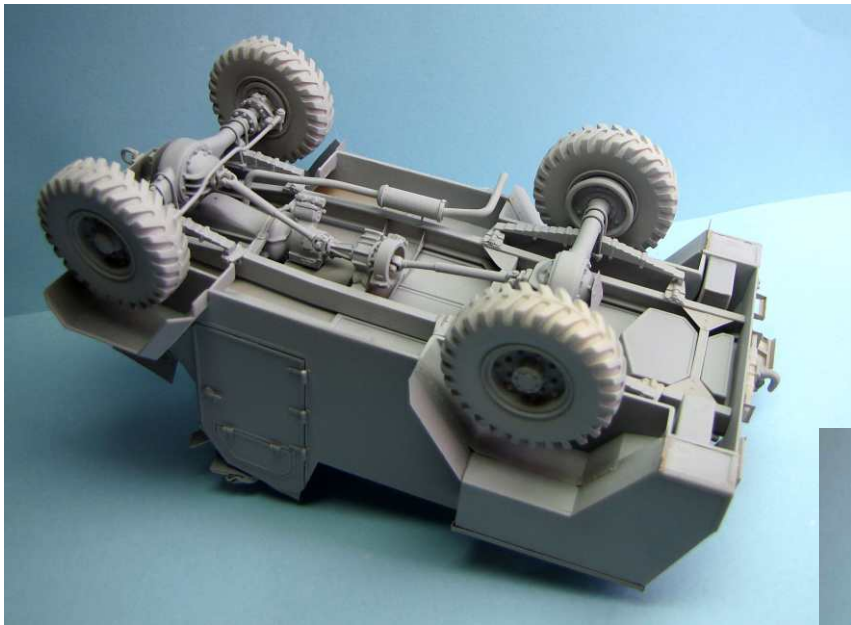

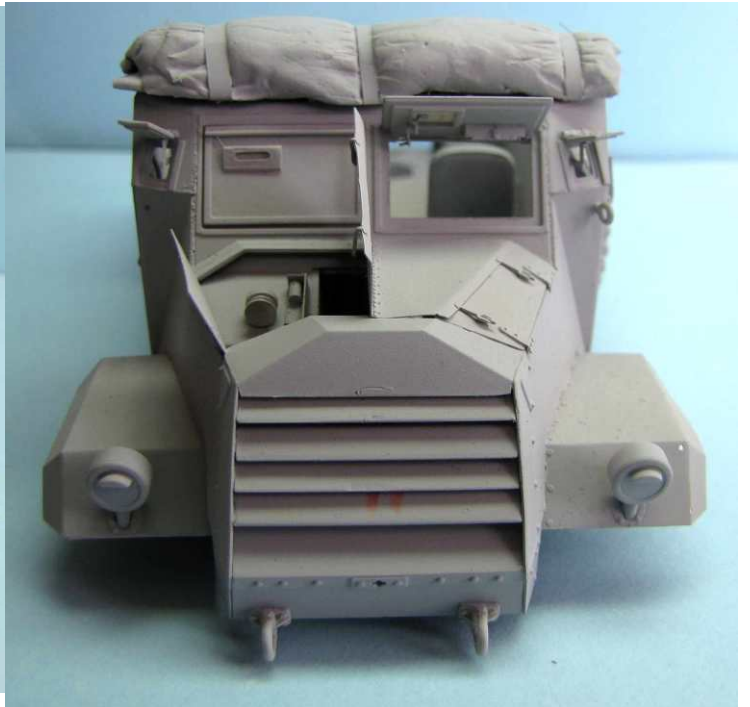
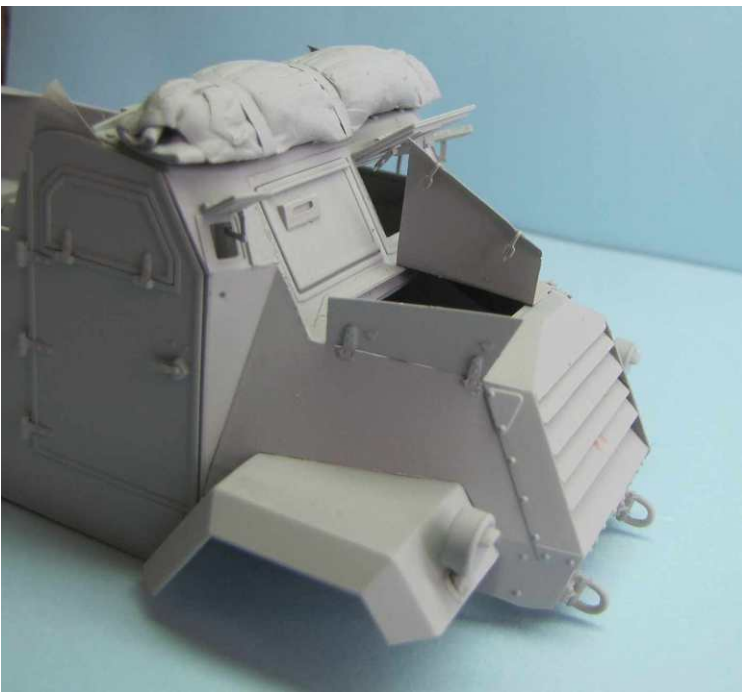

Marking and painting example - used from excellent reference book
AW 09 GM C15TA Armoured Truck
from **Capricorn Publications**
<http://www.capub.wbs.cz/E-Shop.html>

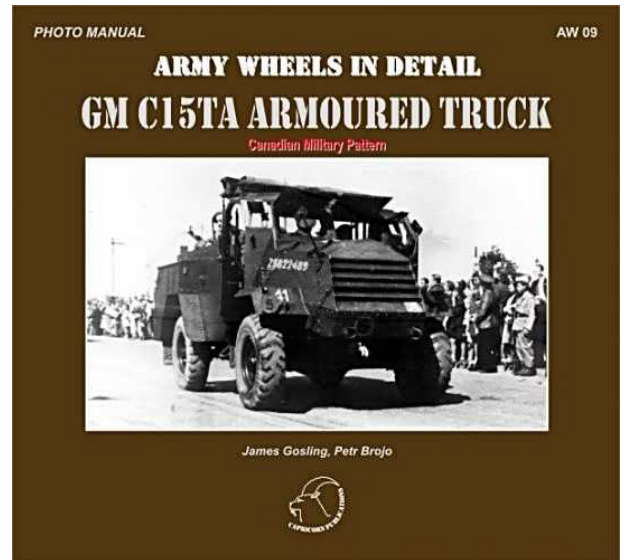

PHOTO MANUAL - MARKING & CAMO

CZ428791 "Aristocrat", 5th Canadian Armoured Division, Belgium 1945.



Z5822489, CIABG, Engineer Company, 1945.



CZ428791 "Aristocrat", 5th Canadian Armoured Division, Belgium 1945.



Z5822489, CIABG, Engineer Company, 1945.



We hope you have enjoyed our first kit. We have improved many things on our next releases, kits dont have ejector marks anymore, our recent kits are full plastic with just few PE parts, mostly optional

If you have experienced missing or damaged part in your kit, contact us directly for replacement at: Mirrormodels.contact@gmail.com

Check for updates and new kits at www.Mirror.models.com

Additional sets and accessories for our kits available at: www.Lzmodels.com

CMP F15 Ford Truck
Precision plastic model



MIRROR Models Ltd.

1/35 Scale

Cab11 and Cab12 option
2A1 and 2B1 Body option

Kit No. 35105

CMP CGT Field Artillery Tractor
Precision plastic model Cab13



MIRROR Models Ltd.

1/35 Scale

Kit No. 35122

Russian Artillery Tractor T-20
Komсомолец
Precision plastic model



MIRROR Models Ltd.

1/35 Scale

Kit No. 35200

US Diamond T969 Wrecker
Precision plastic model



MIRROR Models Ltd.

1/35 Scale

Kit No. 35801

Spring 2013