

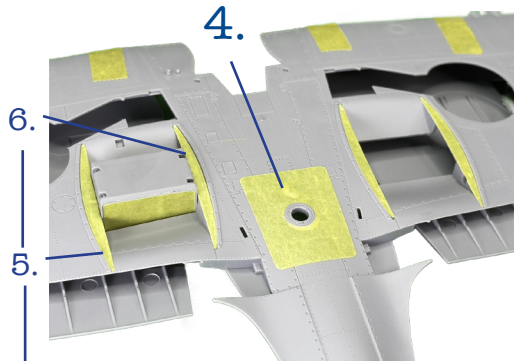

24004 1/24 European Spitfire Mk. IX Essential Mask Set
 Placement Guide for the 1/24 Airfix Spitfire Mk. IX
 24004-1 Mask design page 1

Hawaiian Air Depot
 Designs for Scale Modelers

- 1. Propeller tips
- 2. Main Wheels
- 3. Tail wheel hubs and tires (w/ spares)



from pg. 24005-5

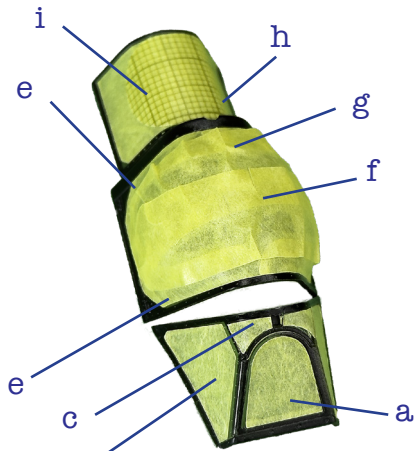
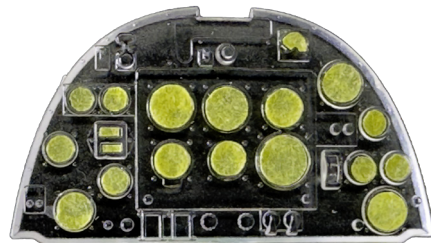
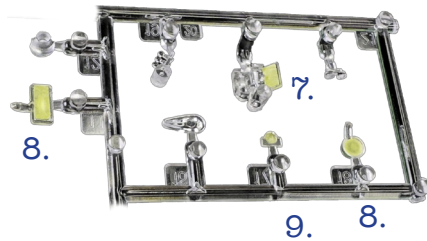

Outside and inside

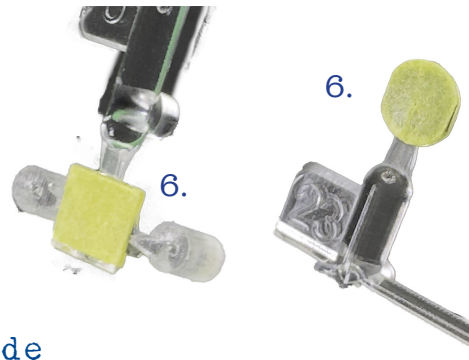

Instrument Panel

Canopy (outside)

Canopy (inside)

1 cm 1 inch

©H AD 24004-1 Canopy (inside)

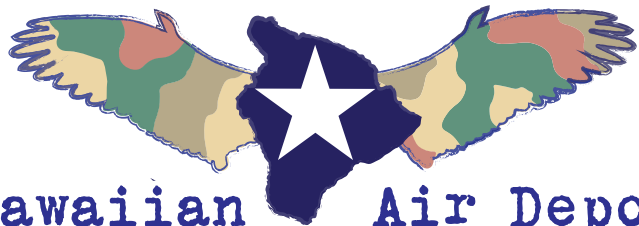

24004 1/24 European Spitfire Mk. IX Essential Mask Set

Placement Guide for the 1/24 Airfix Spitfire Mk. IX
24004-2 Mask design page 2

Hawaiian Air Depot
Designs for Scale Modelers

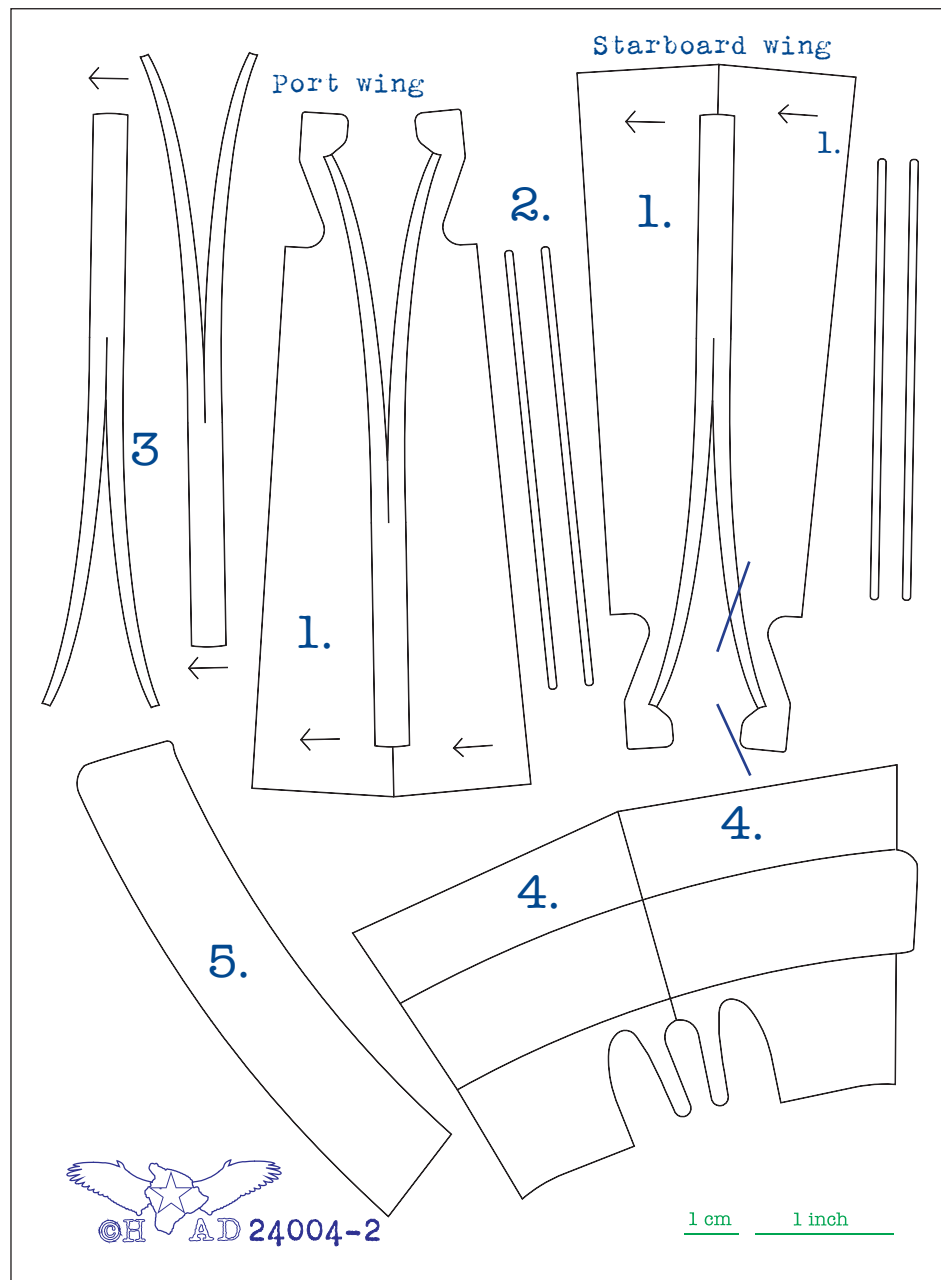
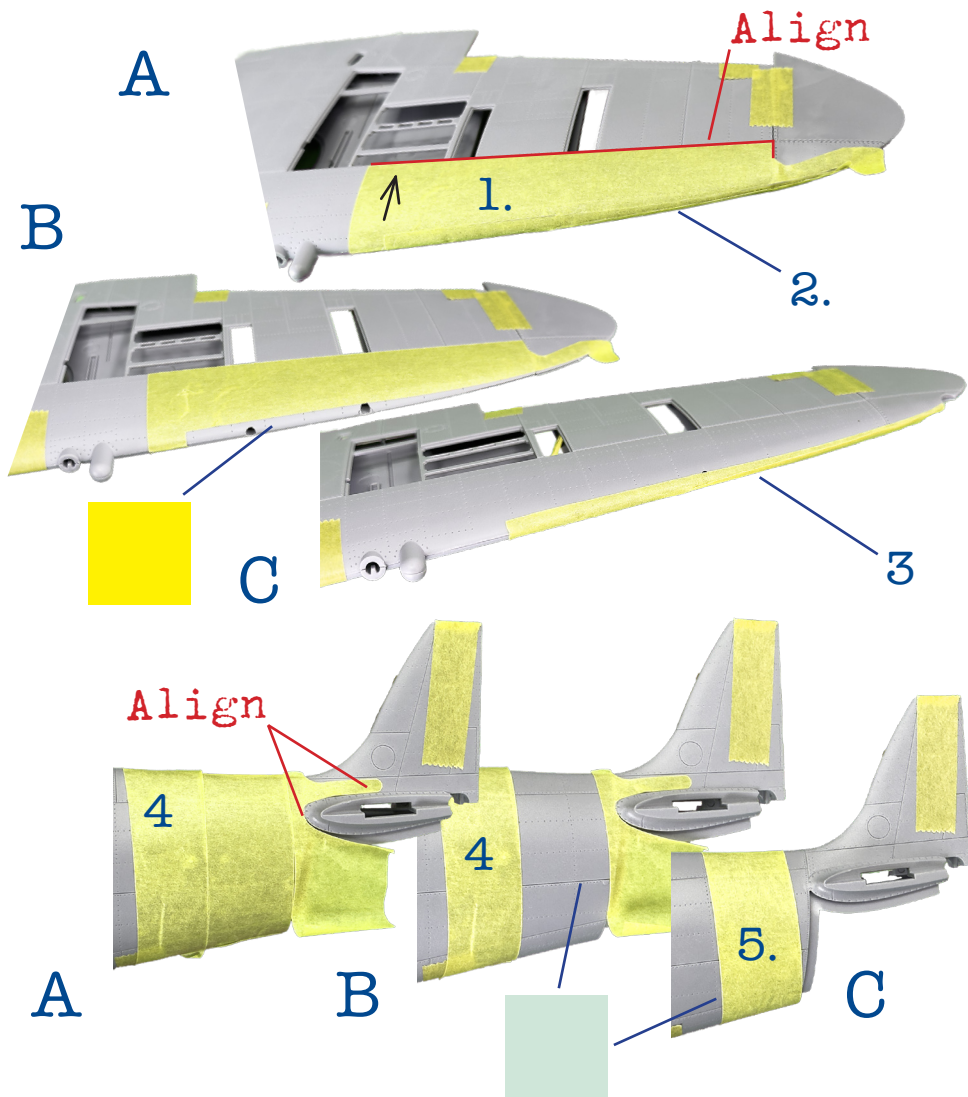

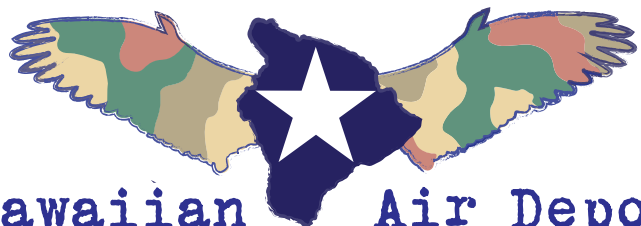

24004 1/24 European Spitfire Mk. IX Essential Mask Set
Placement Guide for the 1/24 Airfix Spitfire Mk. IX
24004-3 Mask design page 3

Hawaiian Air Depot

Designs for Scale Modelers

- 1. Port clipped wingtip light
- 2. Starboard clipped wingtip light

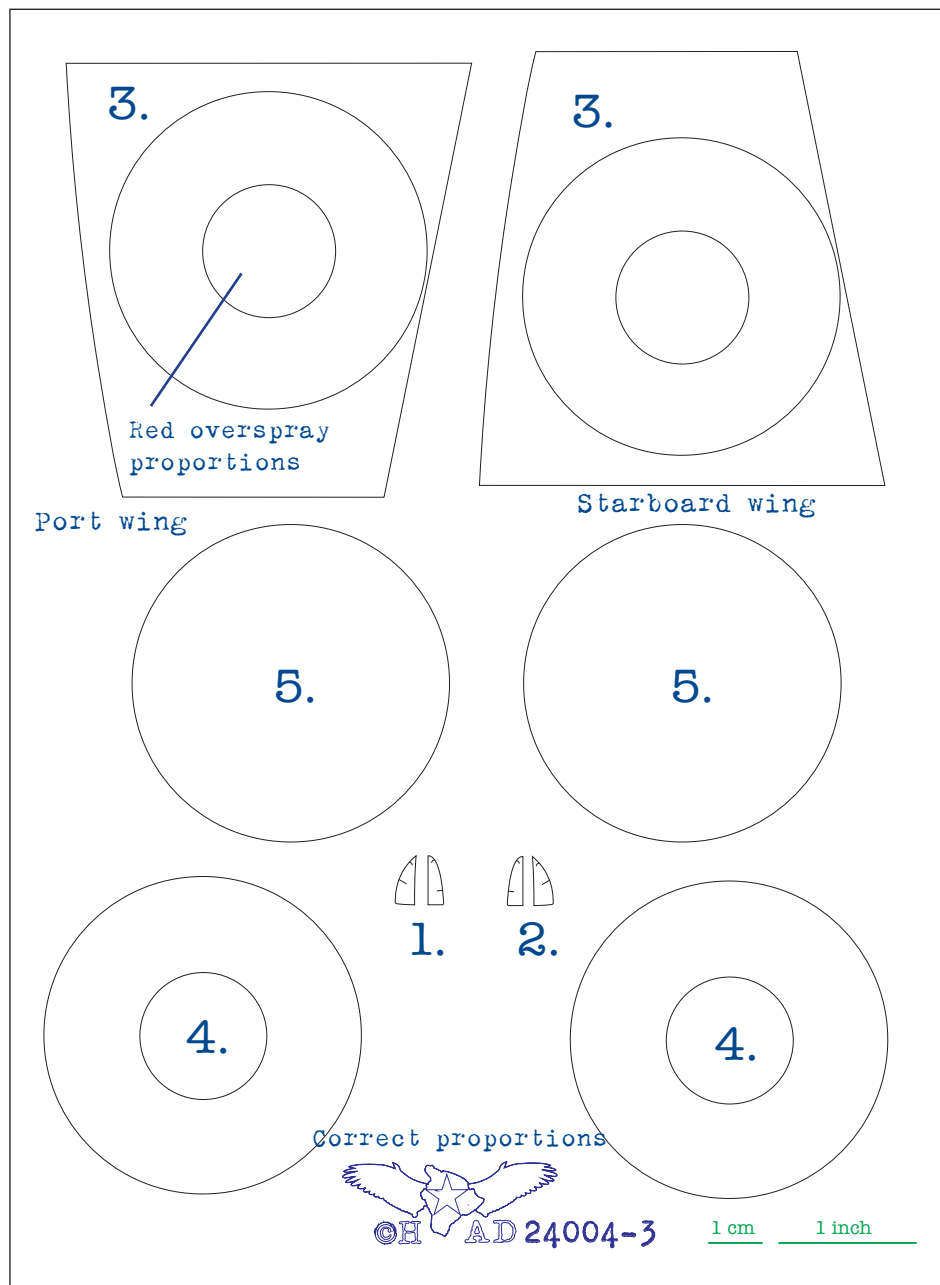
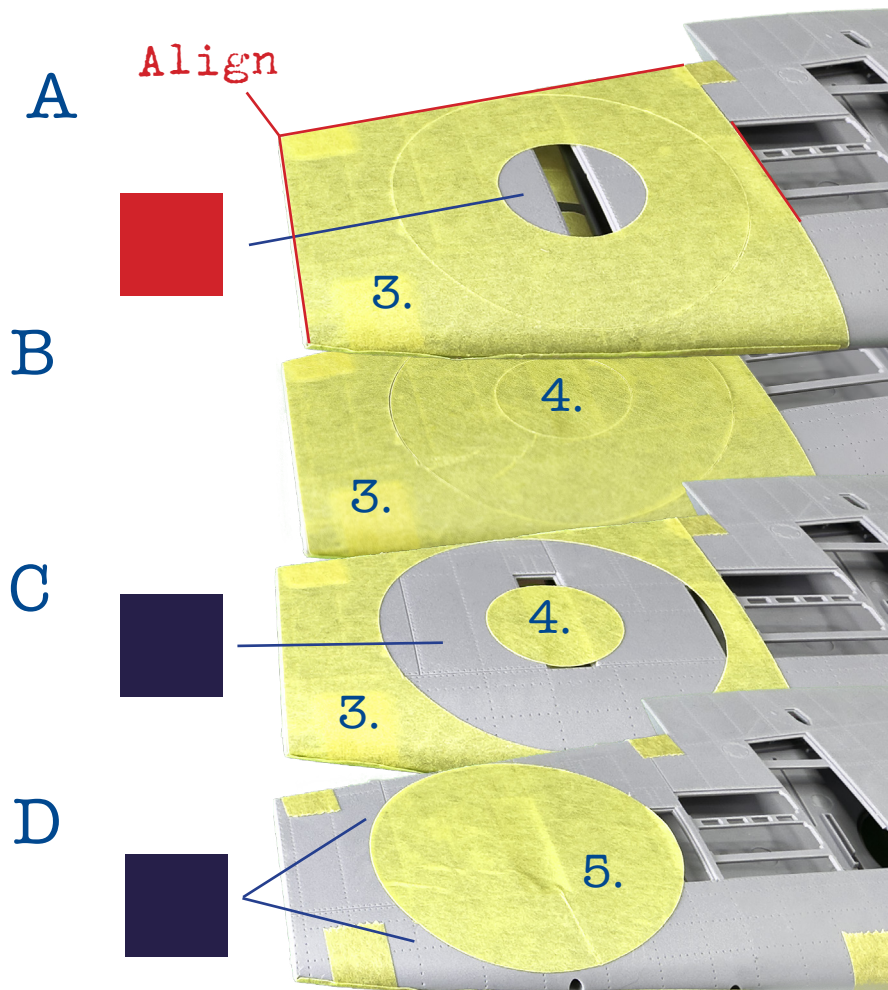

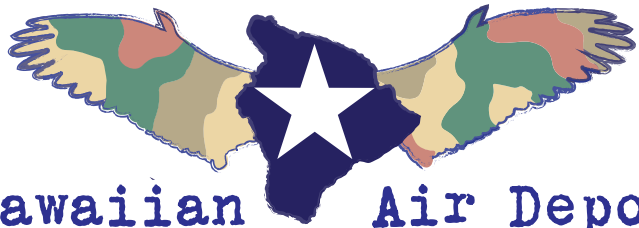

24004 1/24 European Spitfire Mk. IX Essential Mask Set
 Placement Guide for the 1/24 Airfix Spitfire Mk. IX
 24004-5 Mask design page 5

Hawaiian Air Depot
 Designs for Scale Modelers

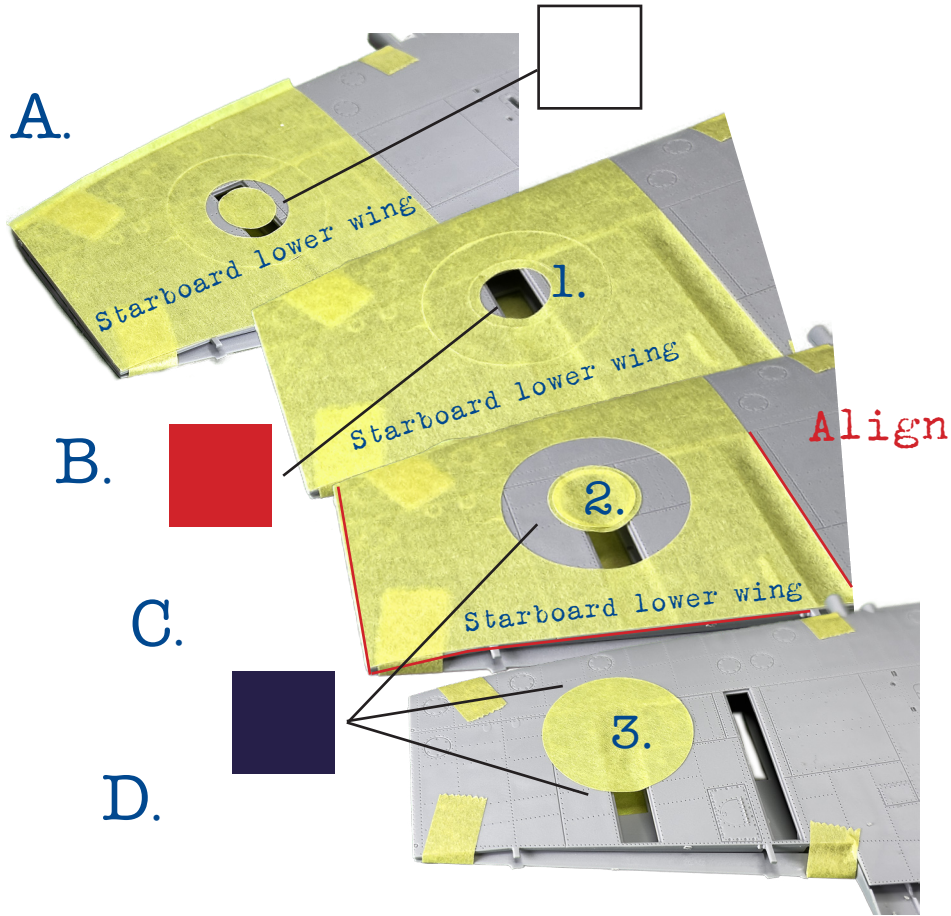

- 4. Radiator faces
- 5. Outboard radiator attachment mask
- 6. Inboard radiator attachment mask

