

# T-34/85 MEDIUM TANK

FLYHAWK®

(PLANT 183. AUTUMN 1944)

## T-34/85中型坦克

(183厂, 1944秋)

UNASSEMBLED MODEL KIT

FH 3023

1/72 SCALE

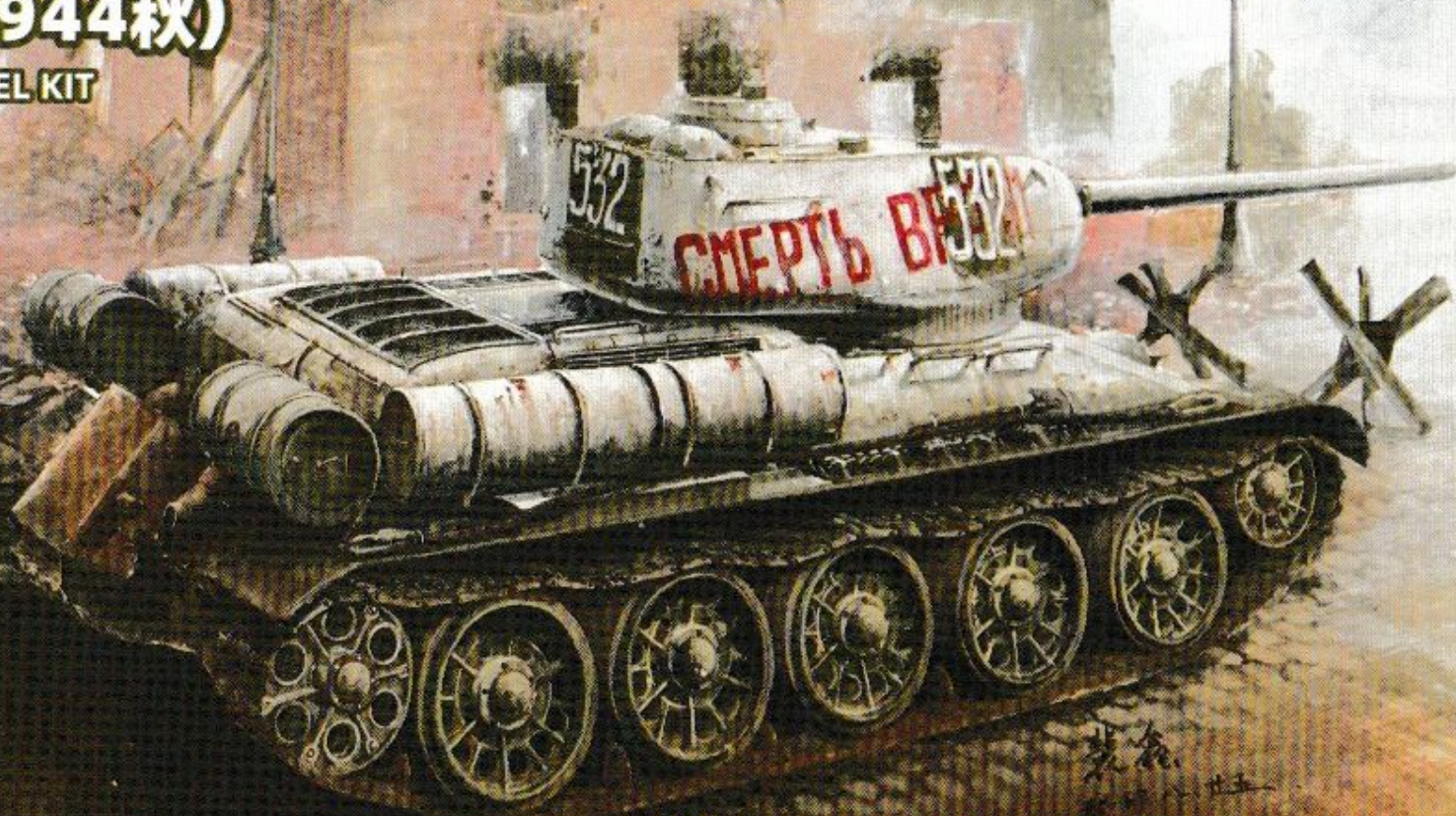

Including PE  
含蚀刻片  
エッチングパーツを含める



# PRODUCT CONTENTS

产品内容

商品内容

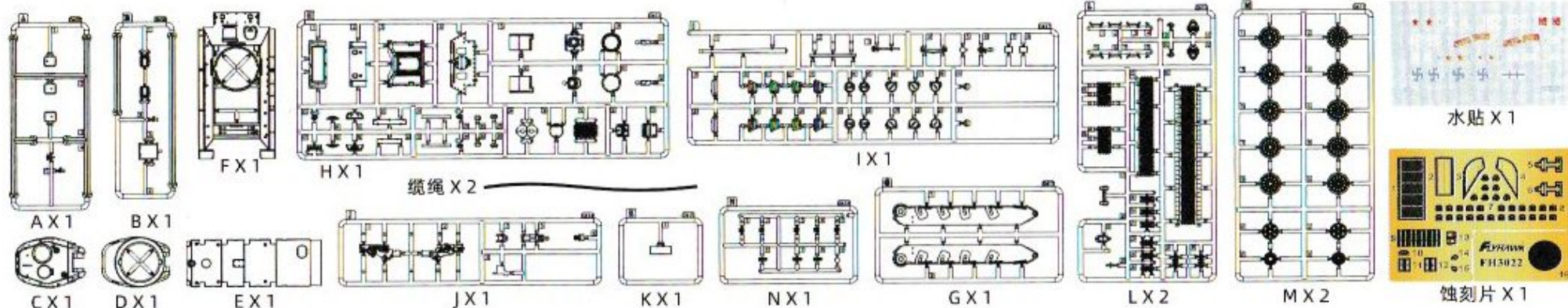

# READ BEFORE ASSEMBLING

组装前必读

組み立て前に必ずお読みください

- Please check out the instruction before assembling.
- Glue and paint are not included.
- Glue, paint and other tools are not allowed to be reached by children.
- Please take care while using tools, glue and paint should be kept away from fire and be sure not working with models in confined chamber.
- The kit may contain metal parts, please be careful while working.

- 组装前请仔细阅读说明书。
- 本套件不含胶水和油漆。
- 胶水、油漆、工具等不可让小孩接触。
- 使用工具时请注意安全，胶水和油漆请勿靠近接触火种，请勿在密封的地方制作模型。
- 套件中可能带有金属零件，请小心制作。

- 組み立て前説明書をよくお読みください。
- 本キットは接着剤とペンキを含みません。
- 接着剤とペンキと道具などを子供に接触しないでください。
- 工具を使用する時安全に注意し、接着剤とペンキは火種に近づかないでください。また、密封の場所で模型を制作しないでください。
- このキットには金属パーツが含まれている可能性があるため、製作時には注意してください。

# ICON INSTRUCTION

图例



CURVE  
弯曲  
BIEGEN  
FRISER  
ROLLER  
曲げるでください



REMOVE  
切除  
ENTFERNEN  
RETIRER  
SEPARARE  
切り取ってください



OPTIONAL  
可选择安装  
NACH BELIEBEN  
FACULTATIF  
FACOLTATIVO  
どちらか選択してください



INSTANT GLUE FOR METAL  
金属用快干胶  
METALLKLEBER  
COLLA A METAL INSTANTANEE  
COLLA Istantanea per Metalu  
瞬間接着剂 (金属用)



BEND DOWN  
向下折弯  
BÜCKTE  
AGGLUTINER VERS LE BAS  
HACIA ABAJO FLEXION  
下向きに曲げてください



BE CAREFUL  
注意  
HIER VORSICHT  
FAIRE ATTENTION  
USARE ATTENZIONE  
注意してください



BEND  
折弯  
BITTE BIEGEN  
PLIER S'IL VOUS PLAÏT  
PIEGARE  
折り曲げてください



MAKE 2pcs  
制作二份  
2 TEILE FERTIGEN  
EFFECTUER 2 PIECES  
FARE DUE PEZZI  
二つ製作してください



APPLY DECAL  
贴上火贴  
HIER ABZIEHBILD  
APPLIQUER DECALCOMANIE  
APPLICARE DECALCOMANIE  
デカールを貼ってください



BENT UPWARD  
向上折弯  
NACH OBEN GEBOGEN  
AGGLUTINER VERS LE HAUT  
DOBLAR  
上方に折り曲げてください



OPEN HOLE  
钻孔  
OFFNEM  
FAIRE UN TROU  
FORD APERTO  
穴を開けてください



FILL HOLE  
填平孔  
SCHLIESSEN  
BOUCHER LE TROU  
FORD PIENO  
穴を埋めてください



DO NOT CEMENT  
不要贴合  
NICHT KLEBEN  
NE PAS COLLER  
NON INCOLLARE  
接着しないでください

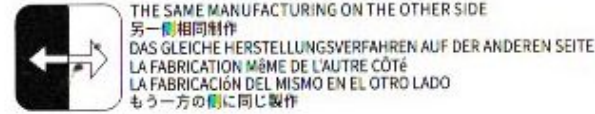

THE SAME MANUFACTURING ON THE OTHER SIDE  
另一侧相同制作  
DAS GLEICHE HERSTELLUNGSVERFAHREN AUF DER ANDEREN SEITE  
LA FABRICATION MÊME DE L'AUTRE CÔTÉ  
LA FABRICACIÓN DEL MISMO EN EL OTRO LADO  
もう一方の側に同じ製作



1



H-2X1

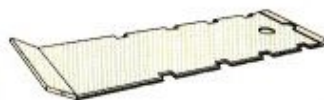

E-1X1



G-2X1



G-1X1

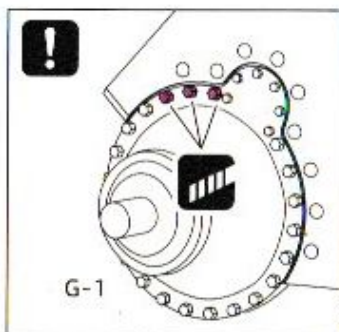



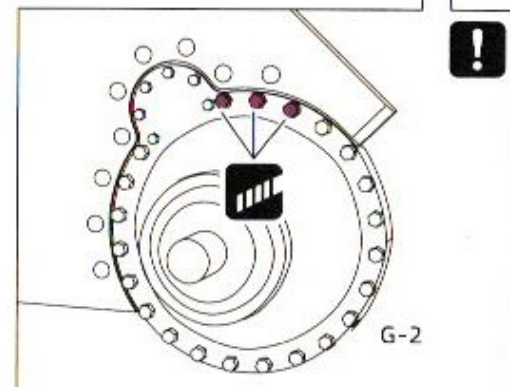
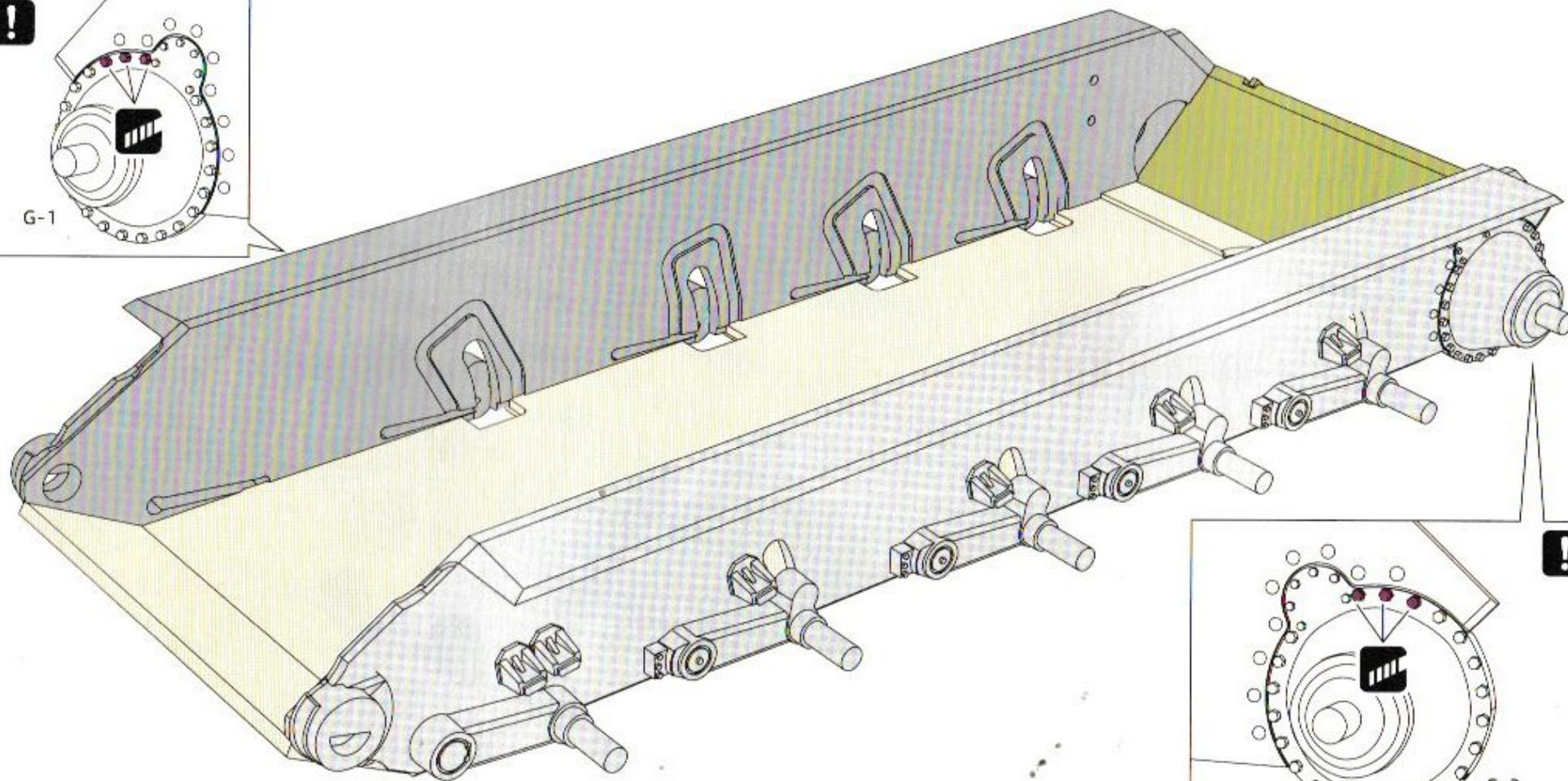







G-1



G-2







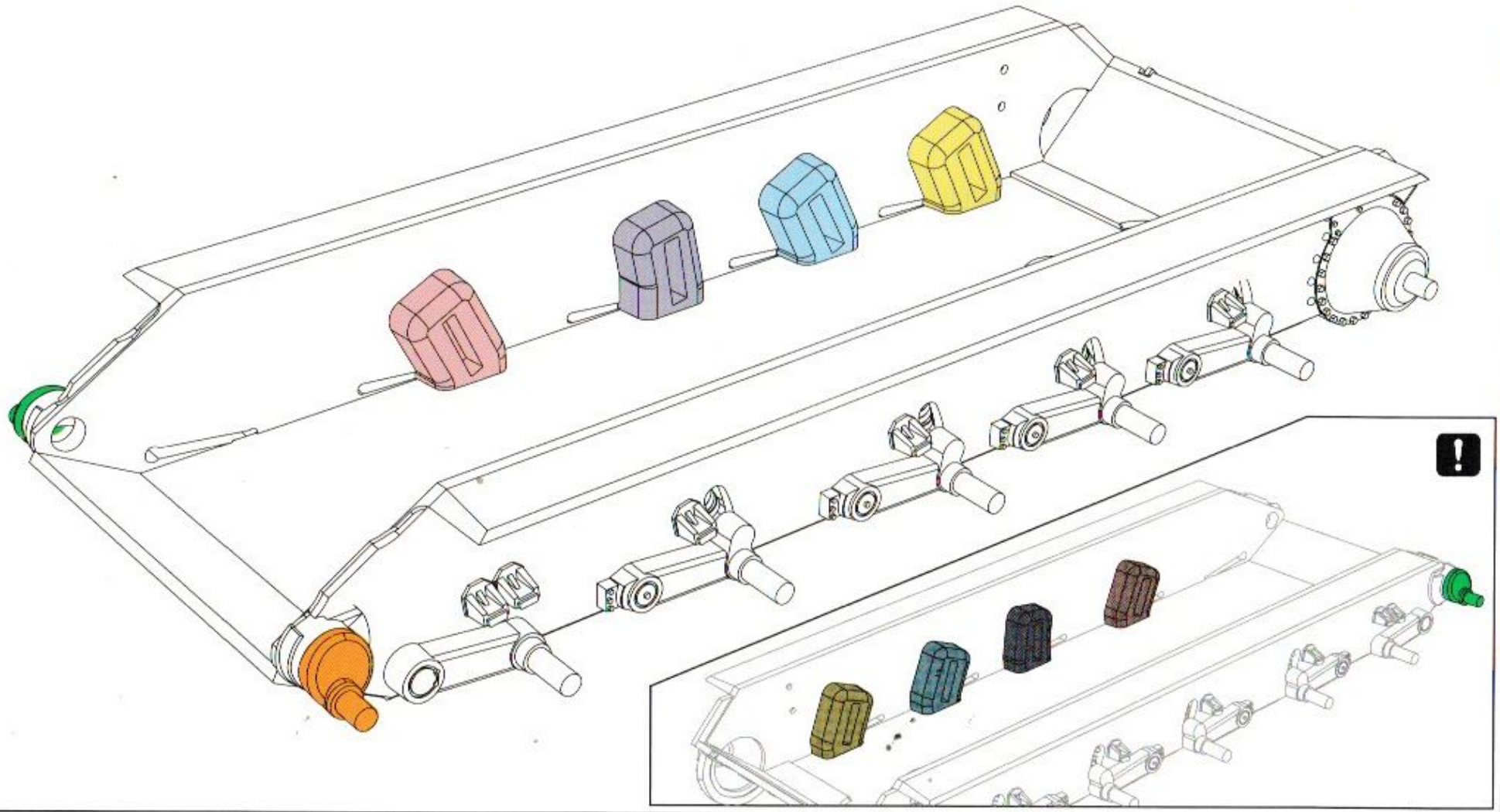

2

									
I-13 X 1	I-12 X 1	I-11 X 1	I-10 X 1	I-24 X 1	I-23 X 1	I-22 X 1	I-21 X 1	I-19 X 1	I-30 X 1



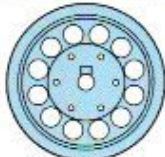





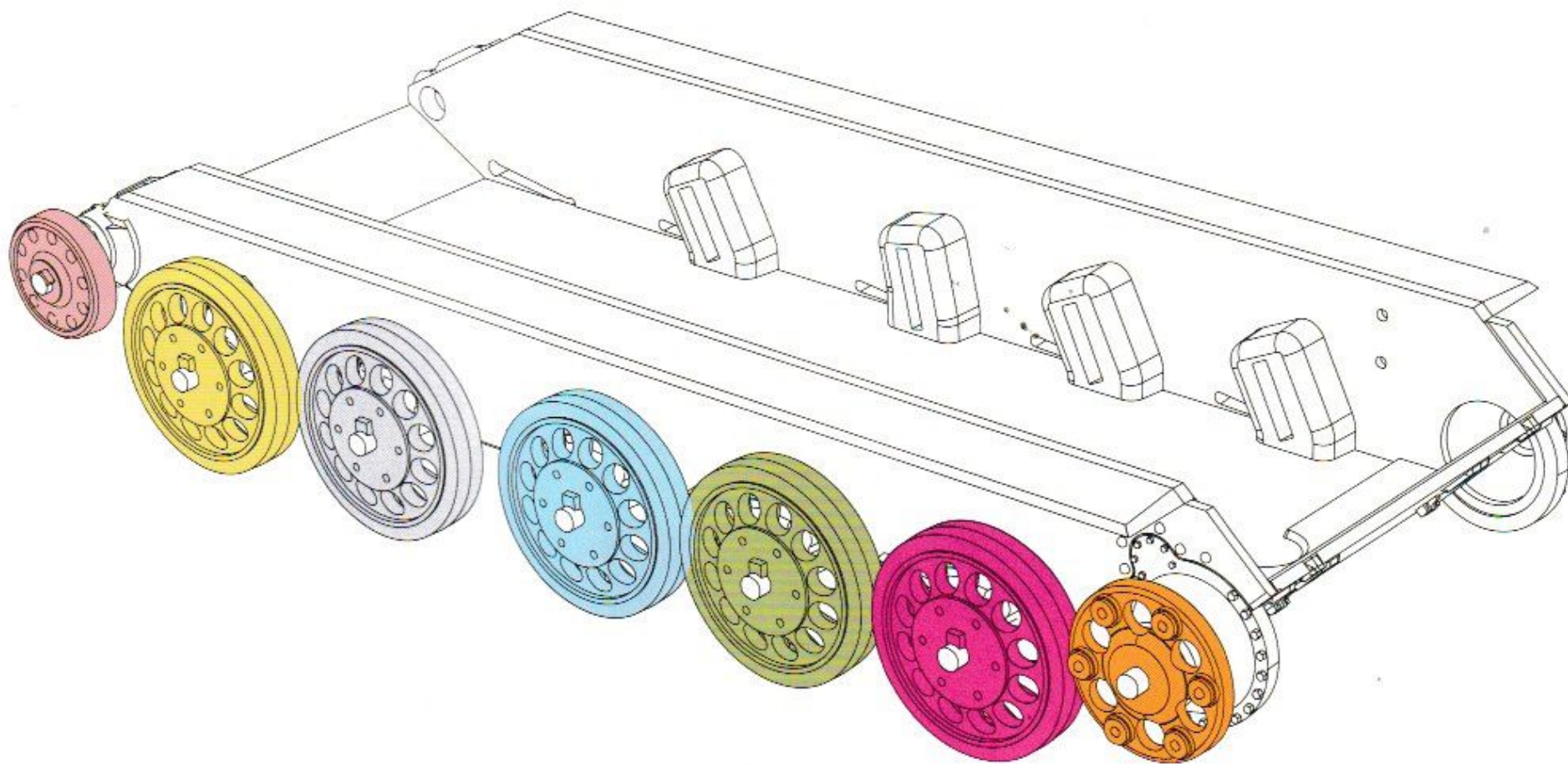

**3**

						
M-14 X 1	M-10 X 1	M-8 X 1	M-6 X 1	M-4 X 1	M-2 X 1	M-12 X 1







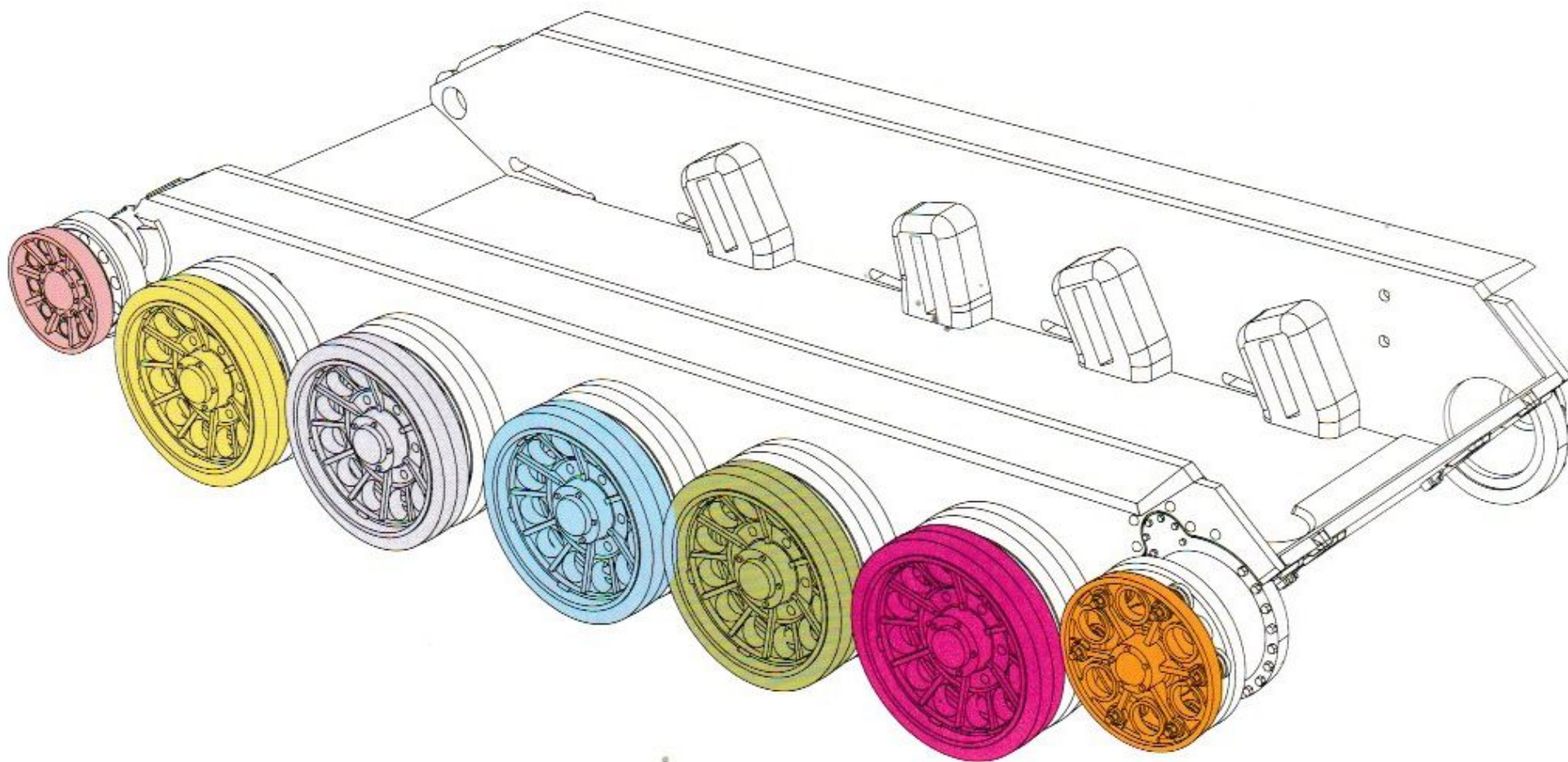



						
M-13X1	M-9X1	M-7X1	M-5X1	M-3X1	M-1X1	M-11X1









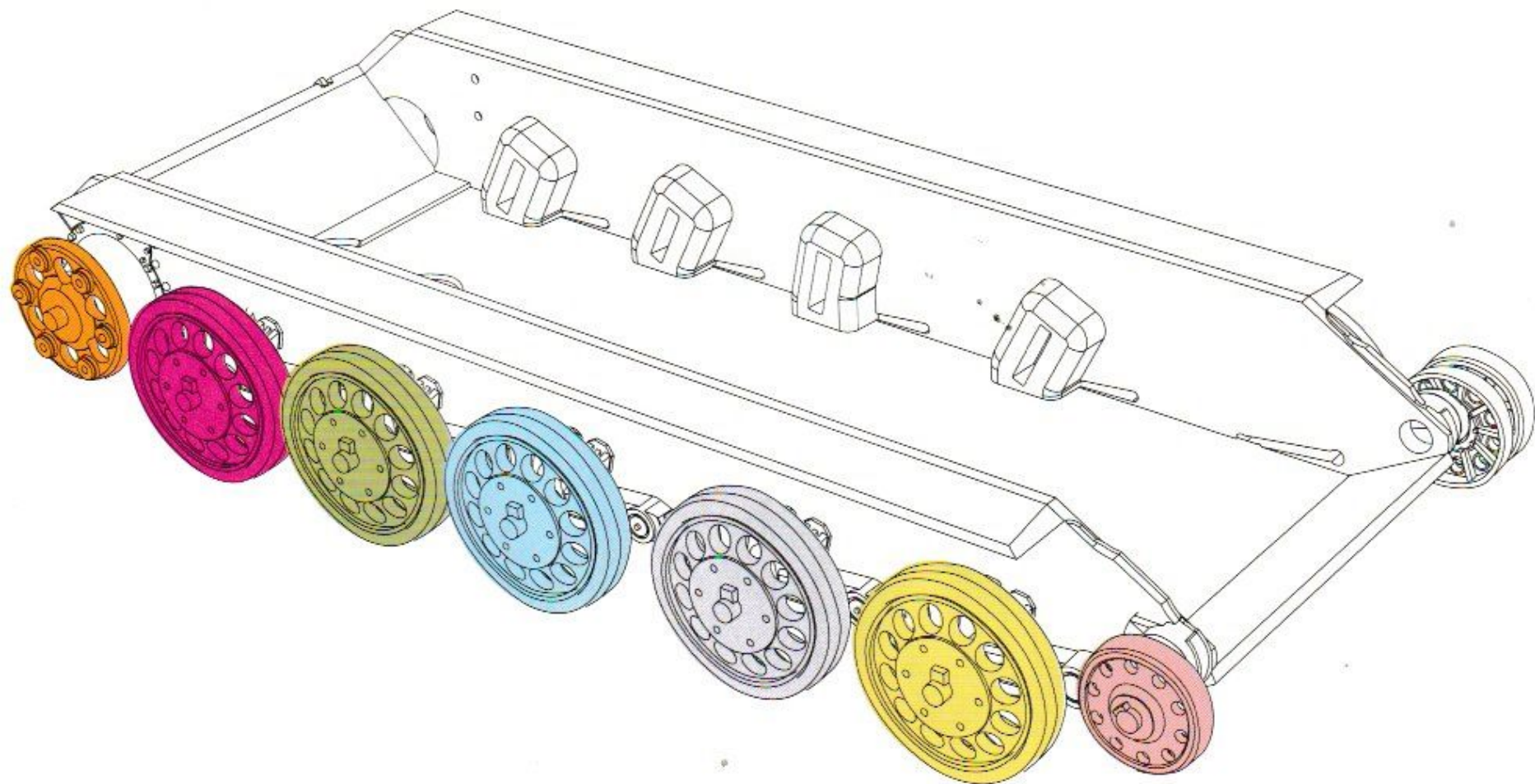

5

						
M-12X1	M-2X1	M-4X1	M-6X1	M-8X1	M-10X1	M-14X1





						
M-11 X 1	M-1 X 1	M-3 X 1	M-5 X 1	M-7 X 1	M-9 X 1	M-13 X 1

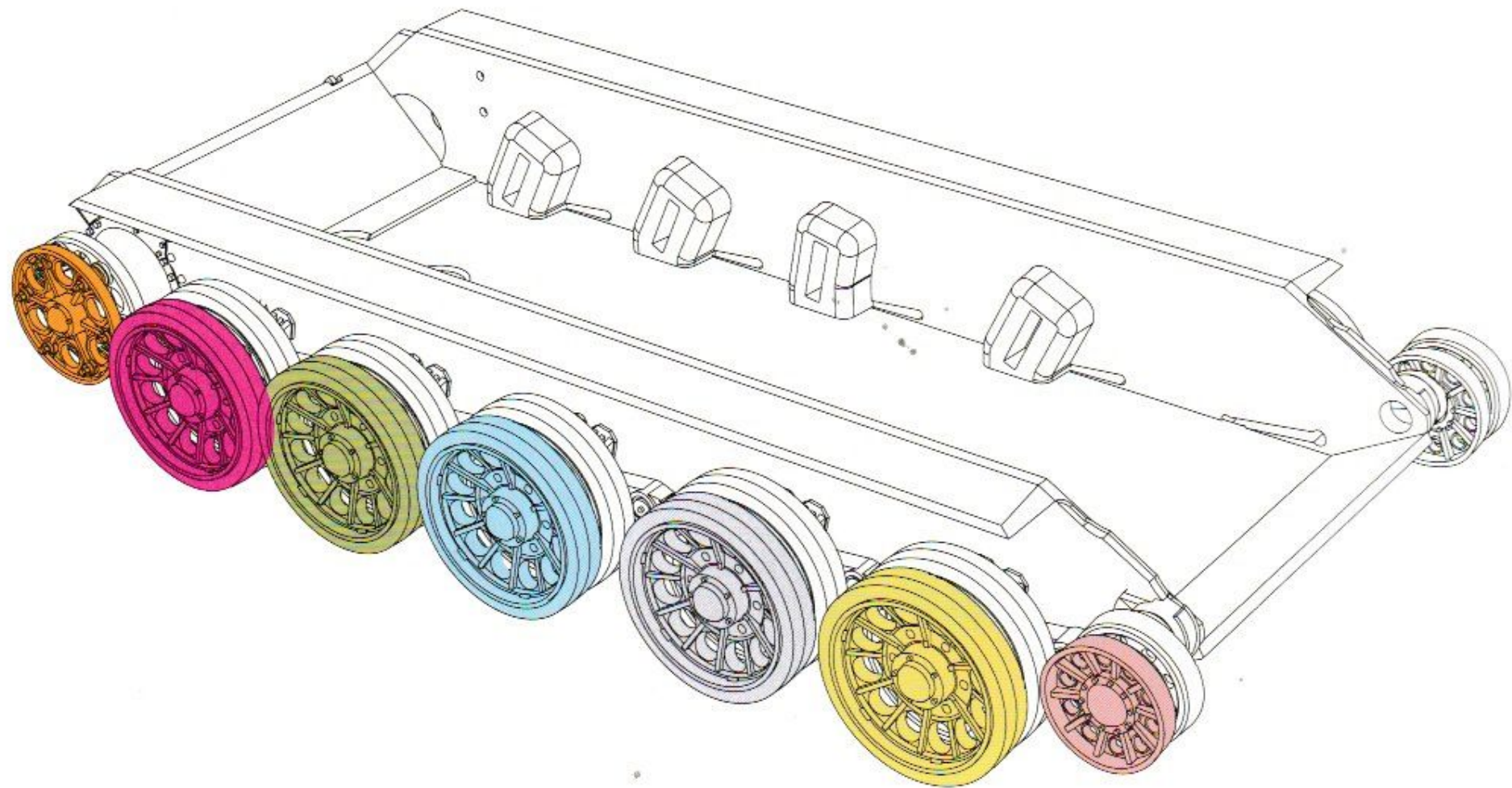



7



H-27 X 1



H-28 X 1



I-20 X 1



I-9 X 1







L-9 X 1

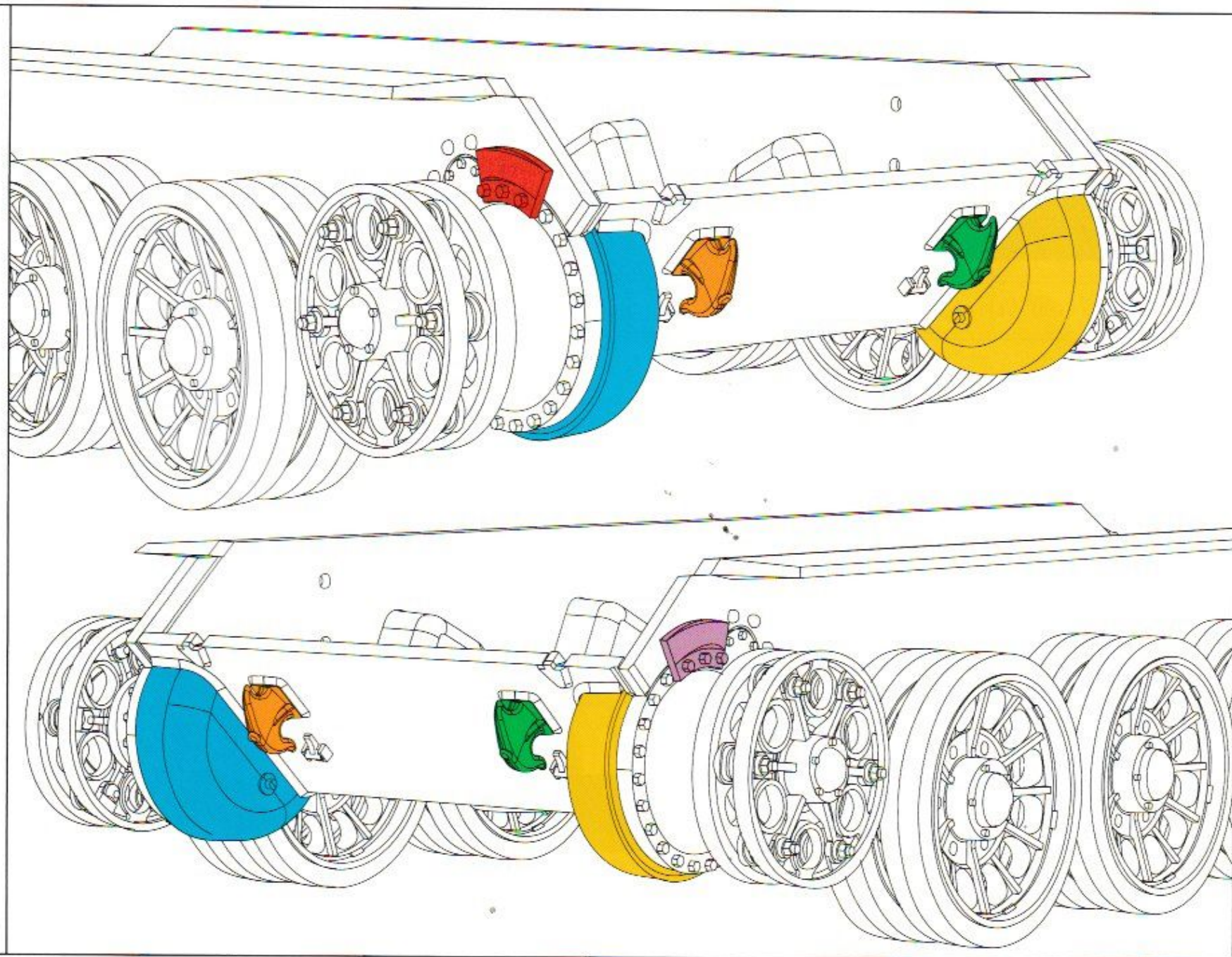

L-10 X 1

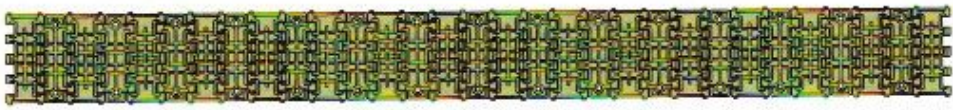

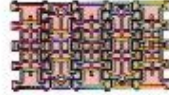
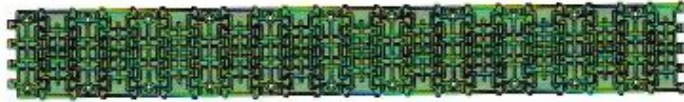



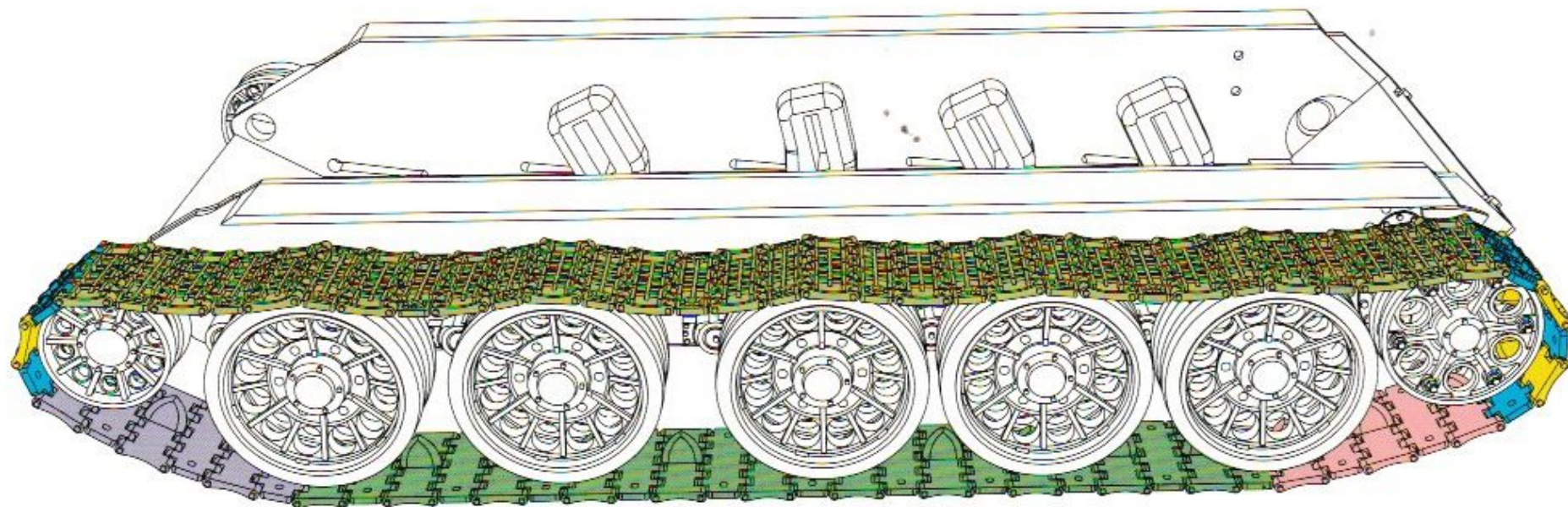

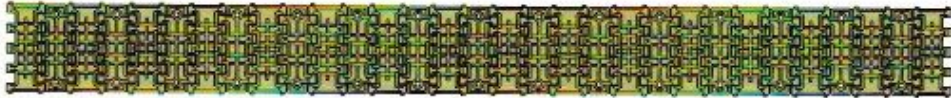

		
L-14 X 1	L-16 X 1	L-15 X 1
		
L-13 X 1	L-23 X 1 (L-24 X 1 / L-26 X 1 / L-27 X 1 / L-28 X 1)	L-18 X 1 (L-19 X 1 / L-21 X 1)







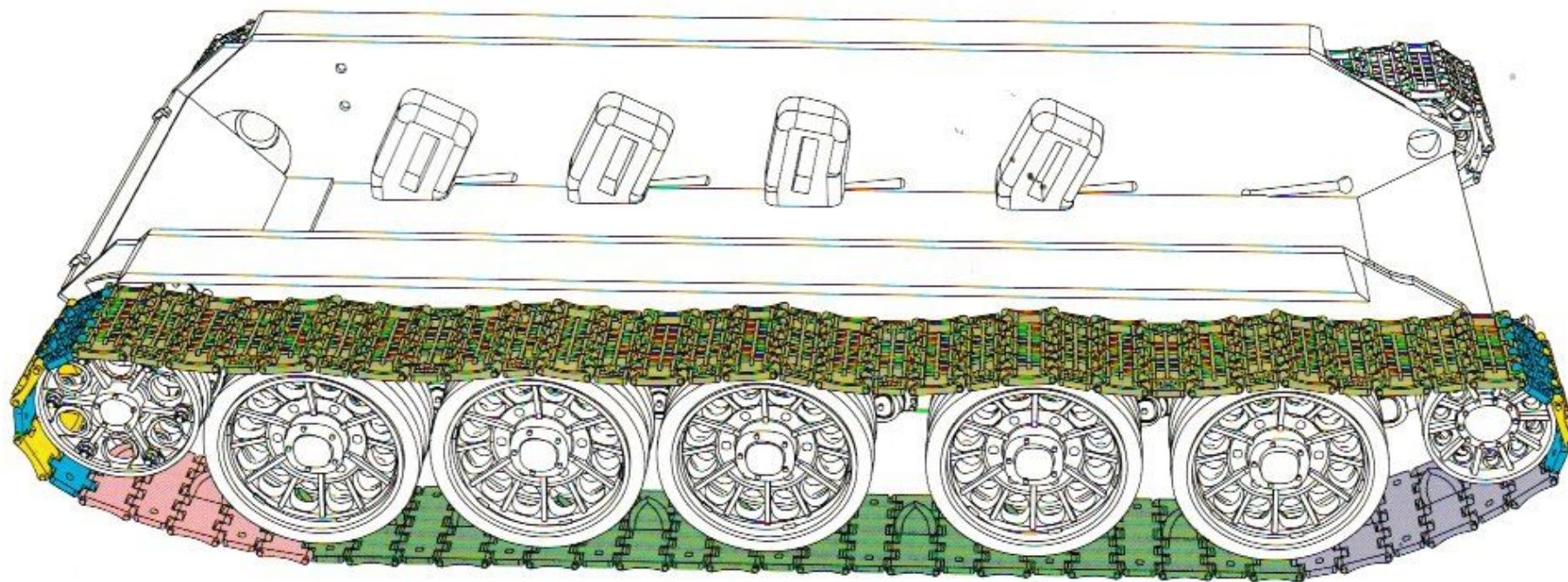



		
L-14 X 1	L-16 X 1	L-15 X 1
		
L-13 X 1	L-23 X 1 (L-24 X 1 / L-26 X 1 / L-27 X 1 / L-28 X 1)	L-18 X 1 (L-19 X 1 / L-21 X 1)



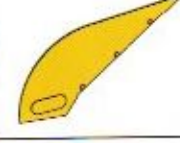
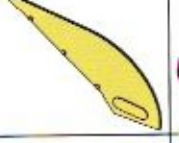



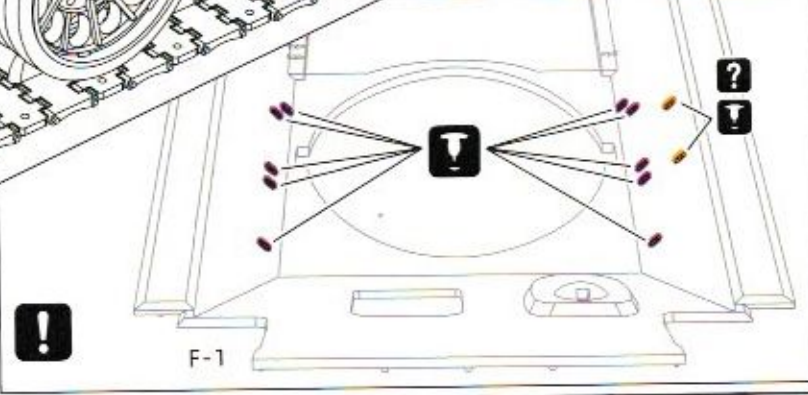
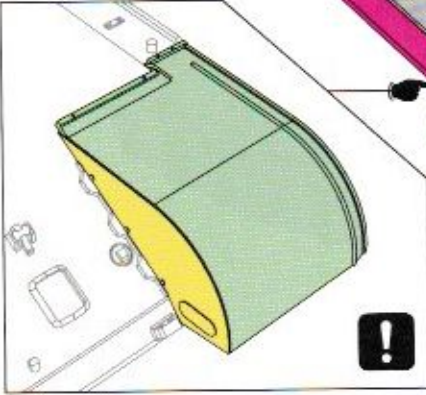
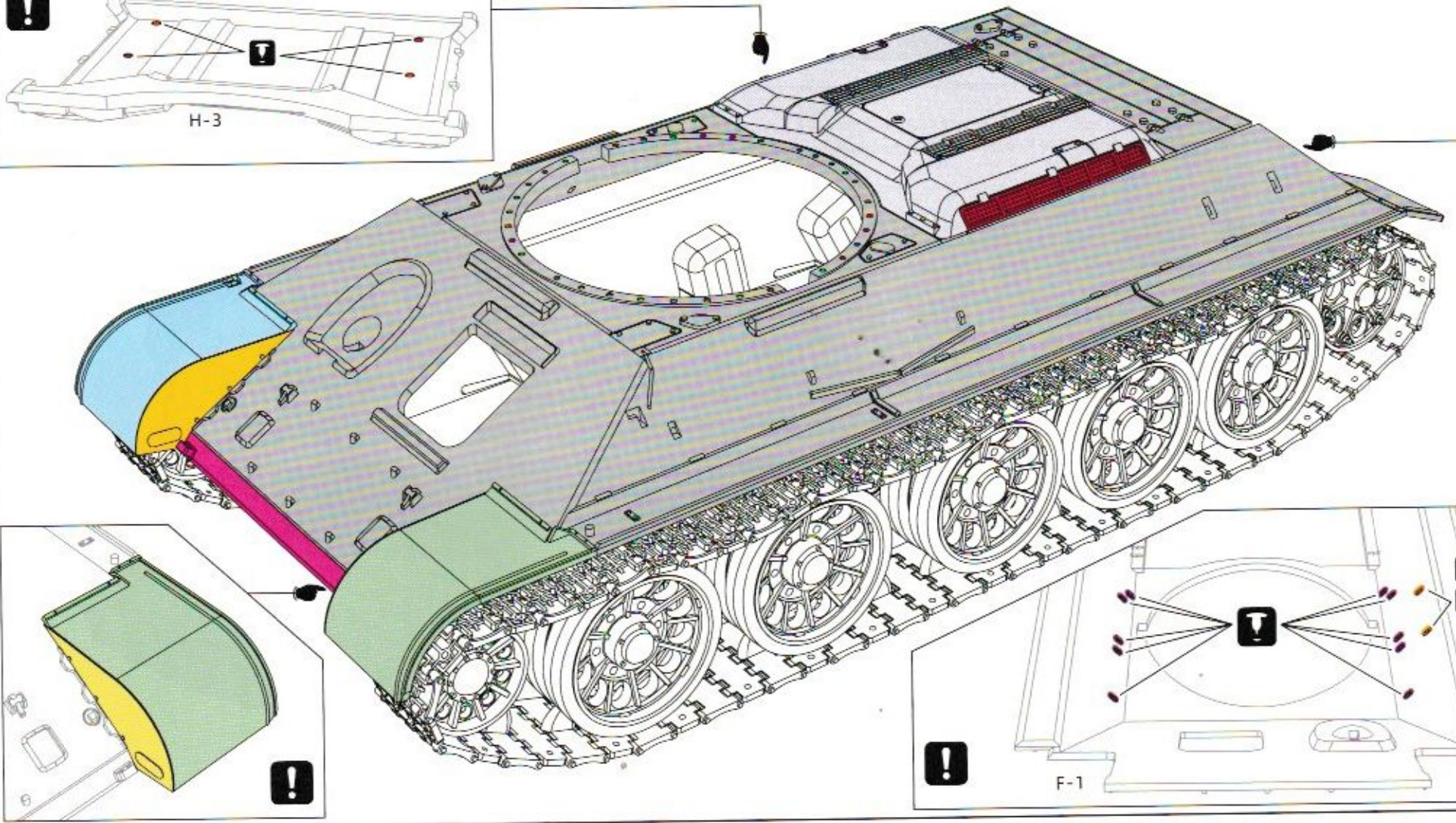
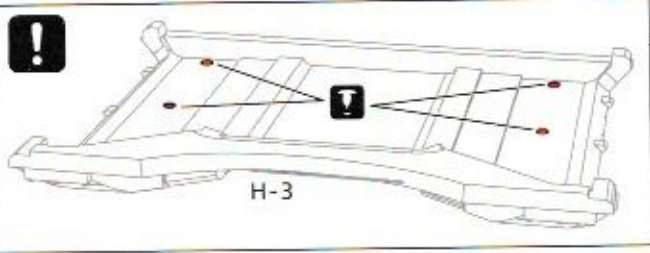



							
F-1 X1	H-3 X1	H-5 X1	H-6 X1	H-22 X1	PE-4 X1	PE-3 X1	I-2 X1

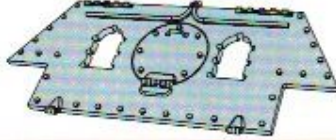

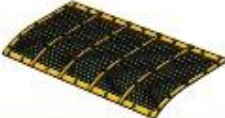

					
PE-10 X 1	H-21 X 1	H-4 X 1	H-1 X 1	PE-1 X 1	L-22 X 2

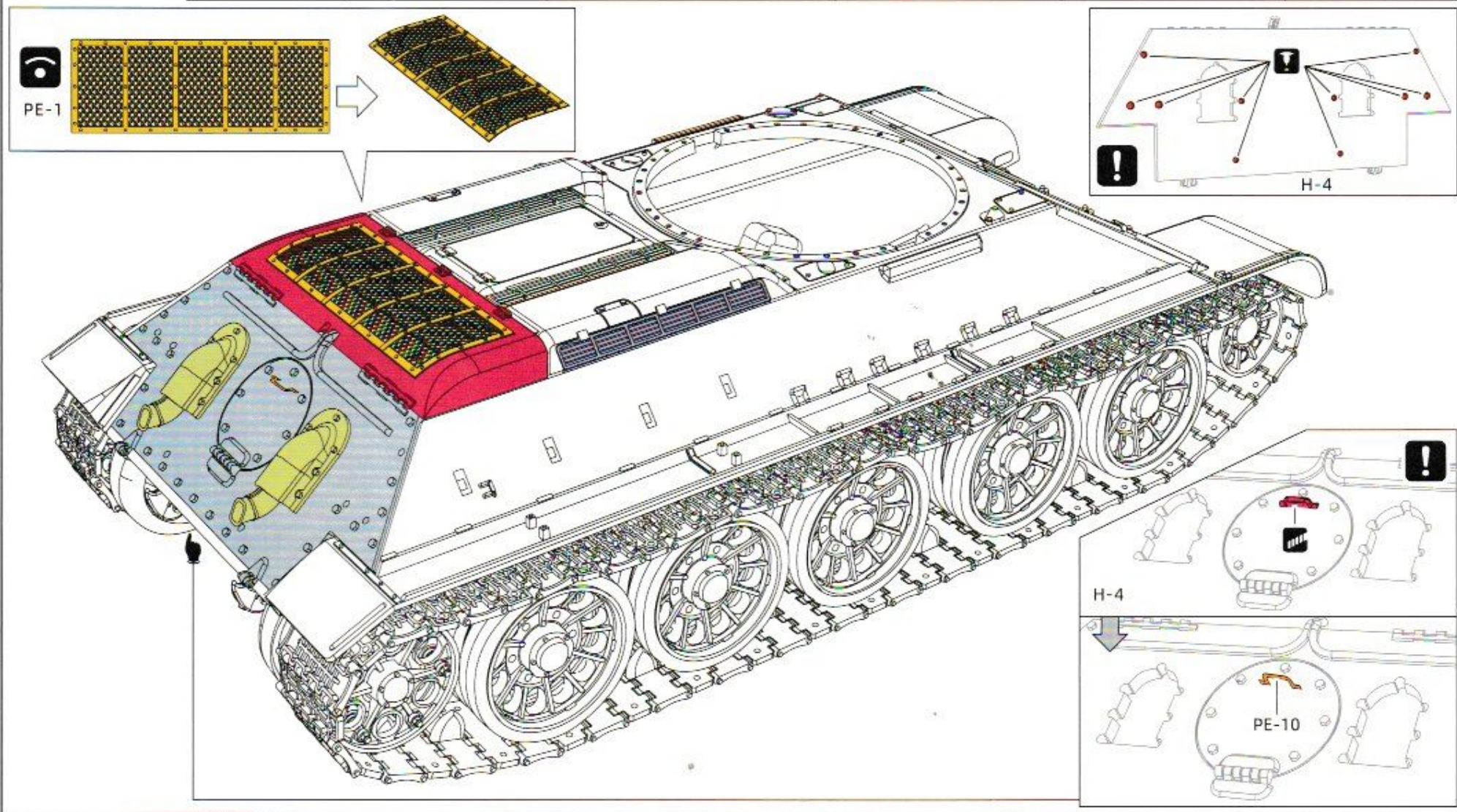

PE-1









H-4



H-4

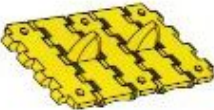



PE-10

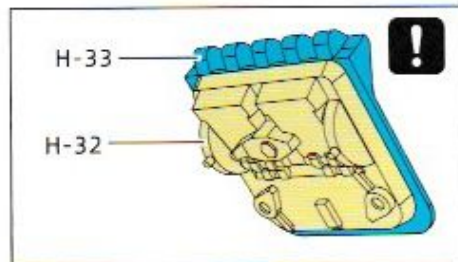
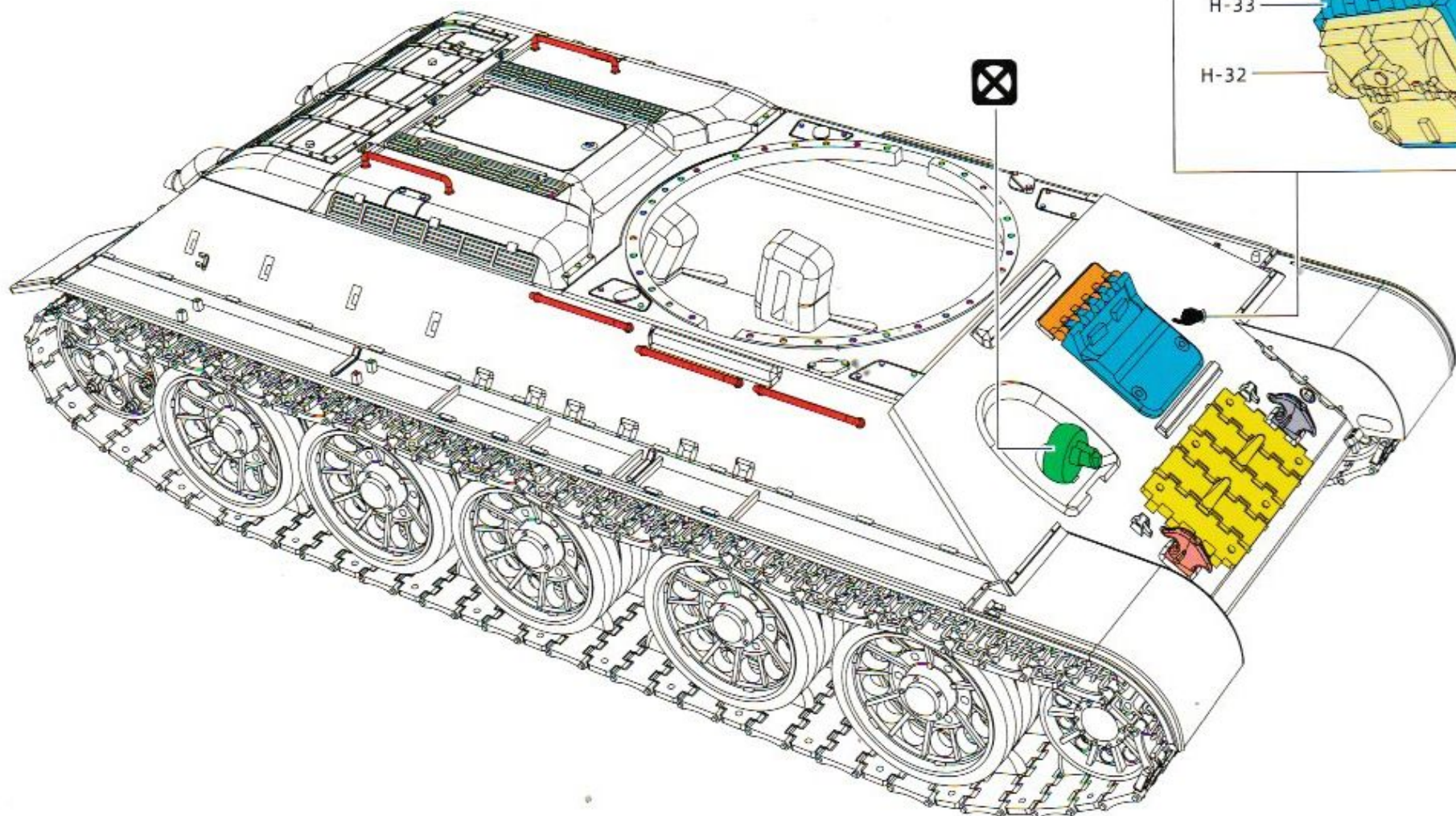

							
H-32 X 1	H-33 X 1	H-17 X 1	H-31 X 1	I-5 X 1	L-9 X 1	L-10 X 1	L-1 X 2 (L-2 X 2 / L-3 X 1)



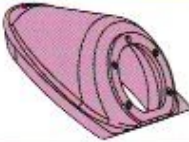
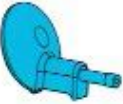

						
L-11 X2	L-12 X1	I-3 X1	H-8 X1	A-4 X1	H-26 X1	H-25 X1

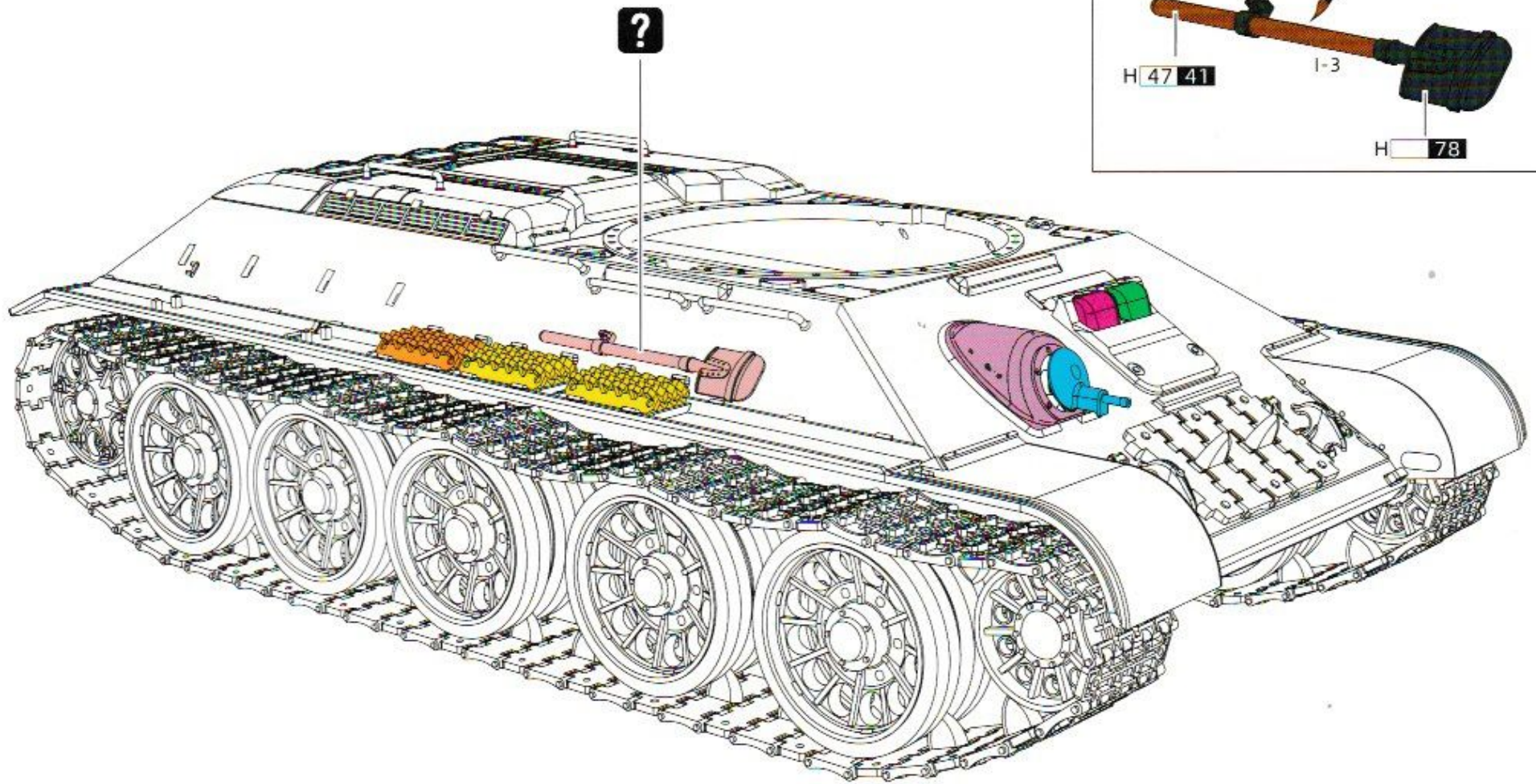
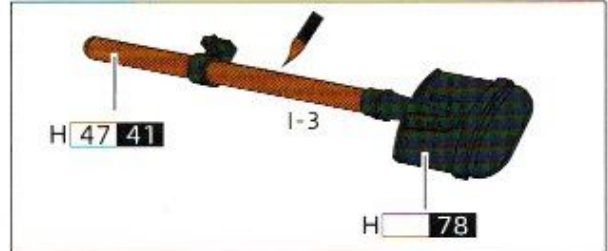





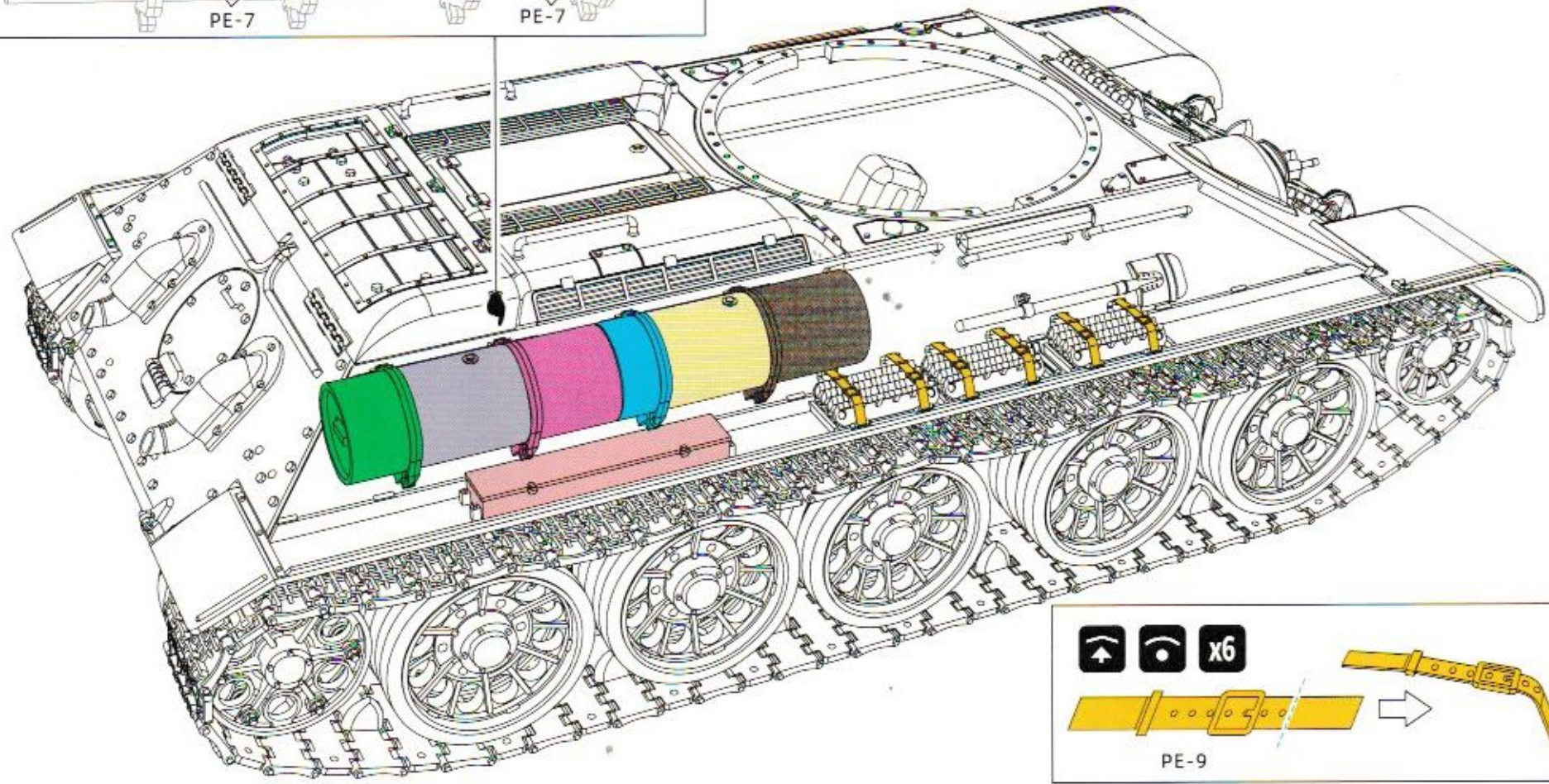
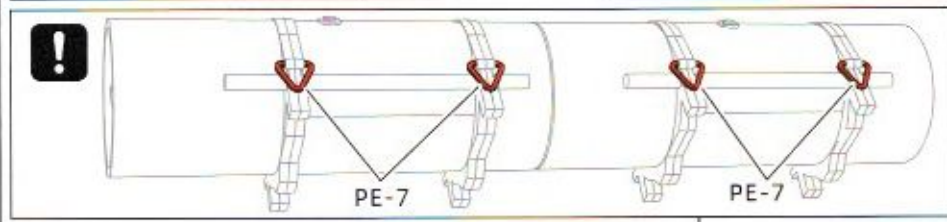

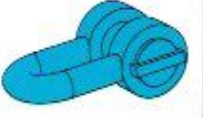

H-20 X 1	PE-9 x 6	I-16 X 1	A-3 X 1	I-17 X 1	I-29 X 1	A-1 X 1	I-18 X 1	PE-7 X 4







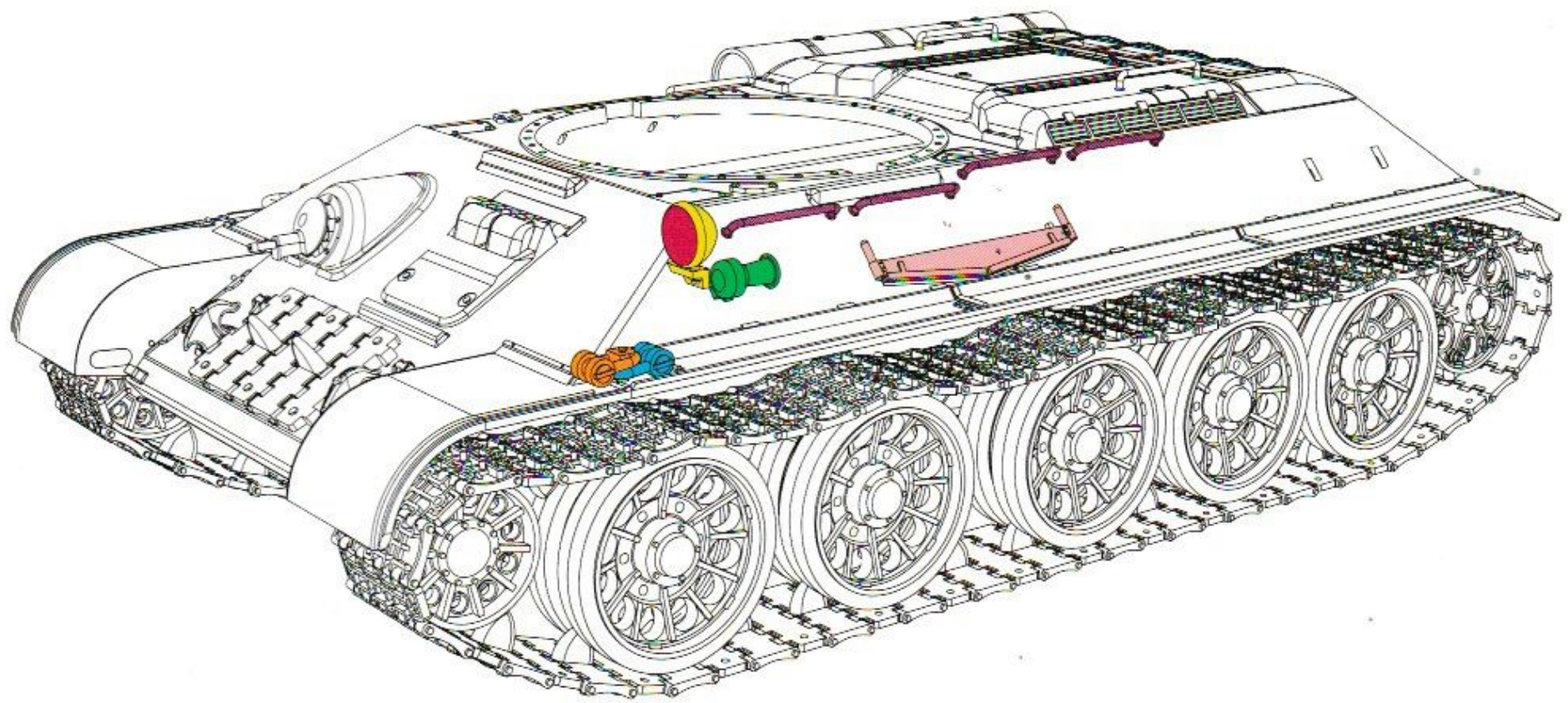

						
H-23 X 1	H-24 X 1	N-9 X 1	I-6 X 1	B-2 X 1	I-4 X 1	L-6 X 2(L-7 X 2)

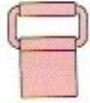



					
H-16 X 1	PE-13 X 2	PE-7 X 2	I-28 X 1	A-2 X 1	I-27 X 1

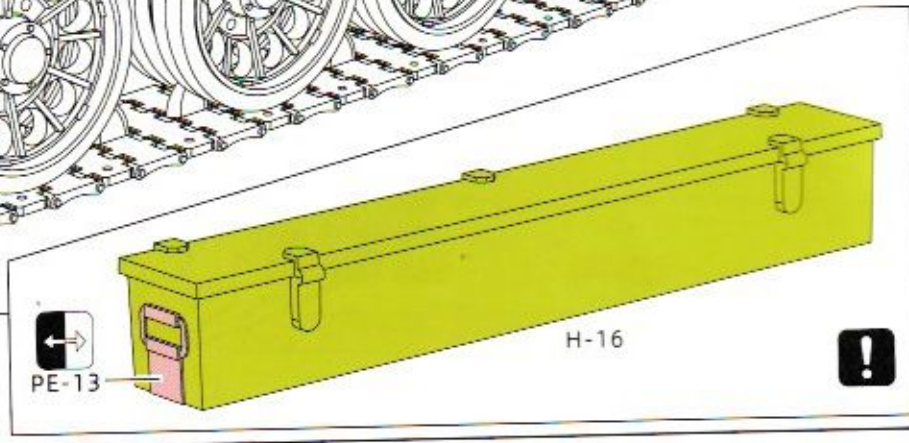
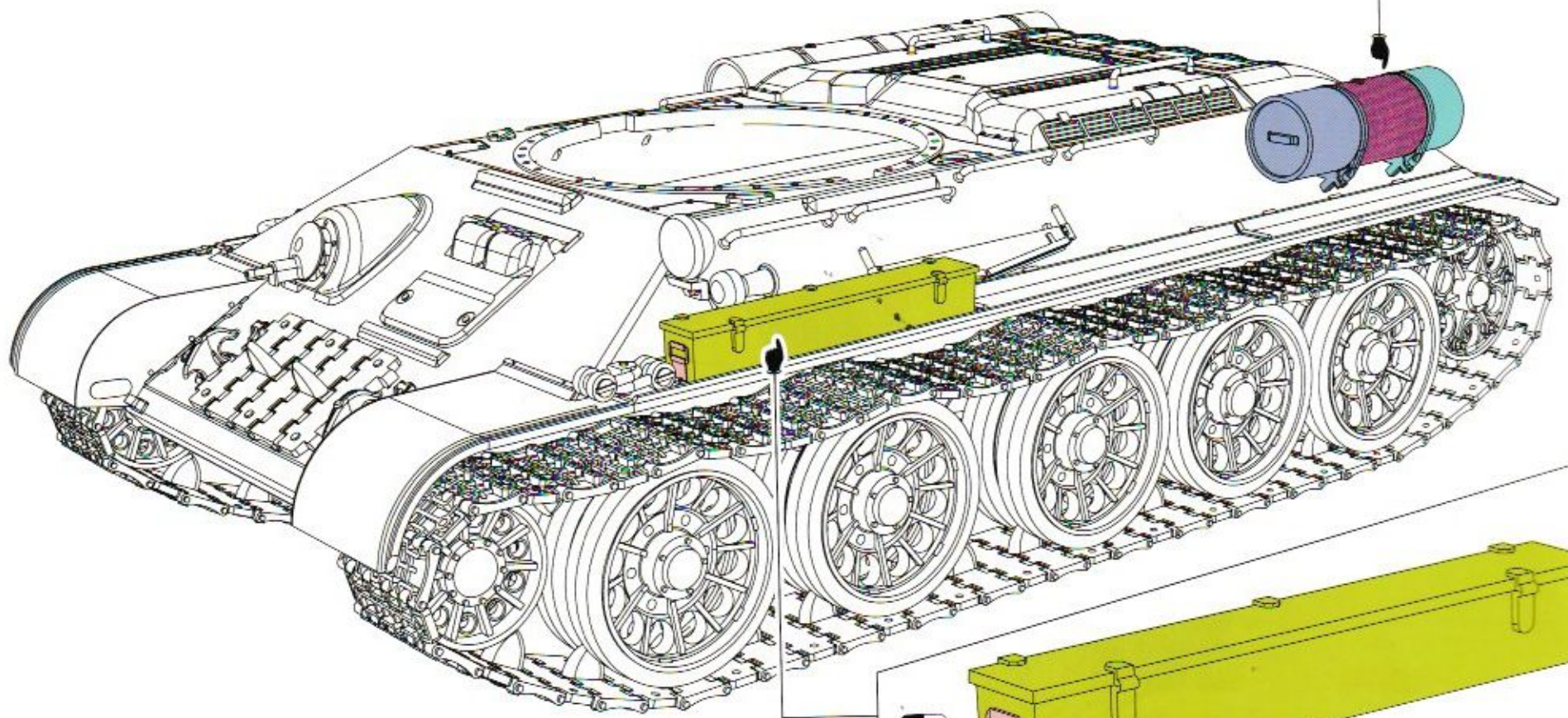
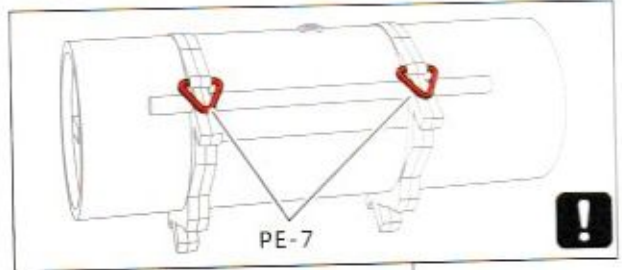



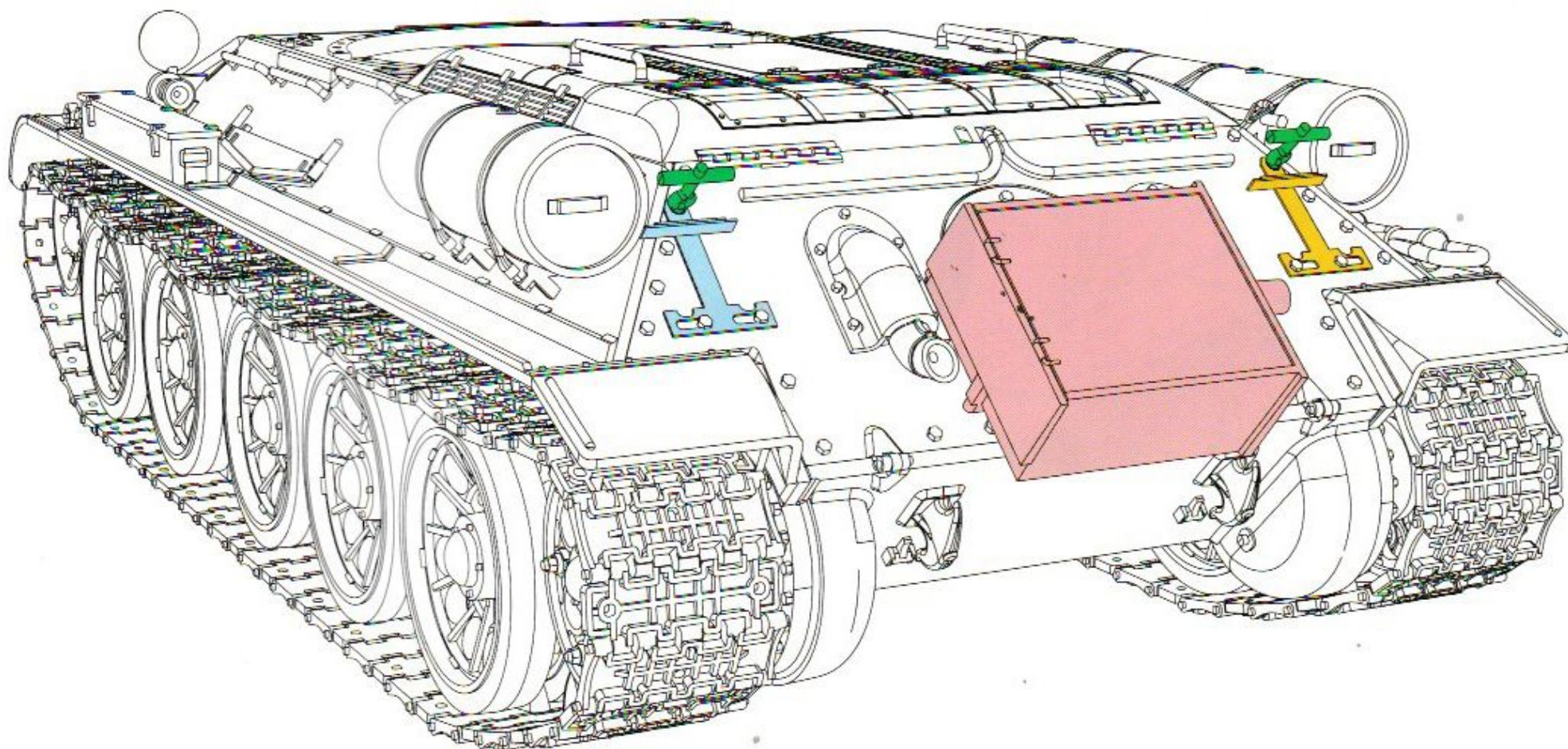
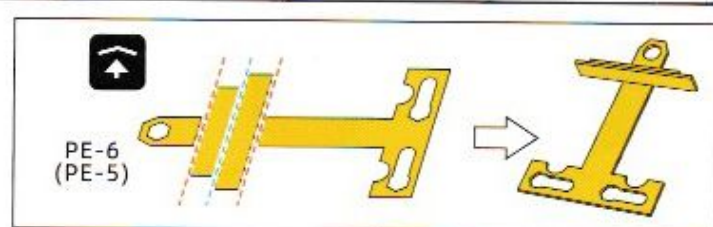
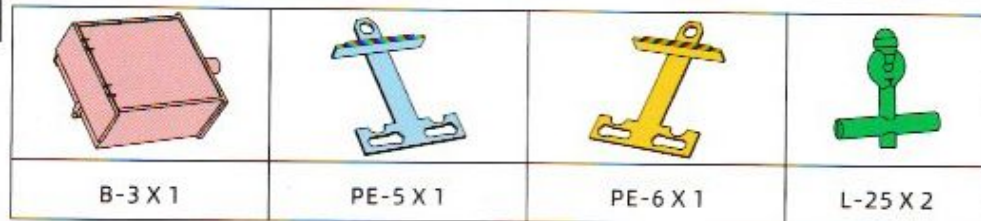





I-14 X 1 (I-15 X 1)



I-25 X 1 (I-26 X 1)



B-1 X 1 (B-2 X 1)

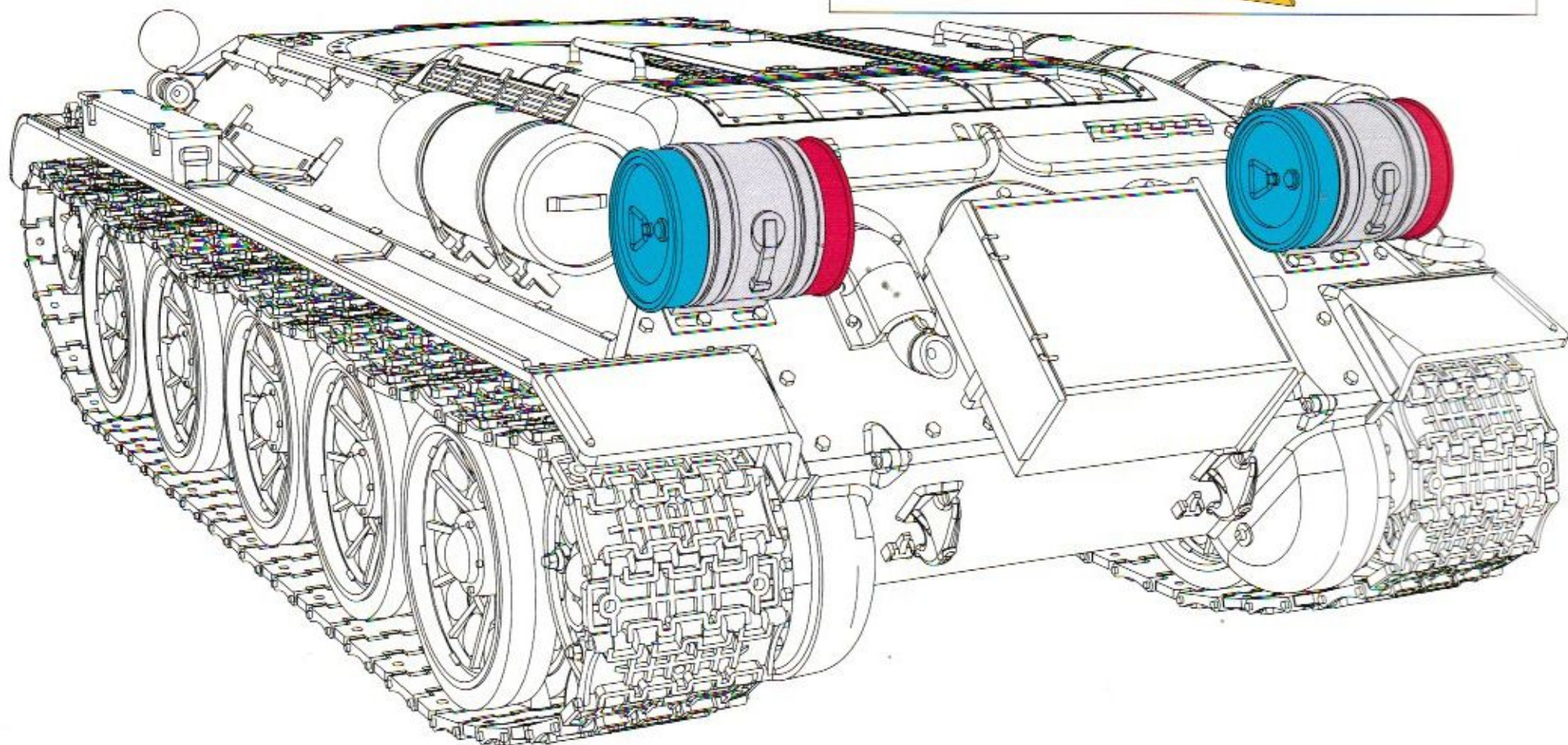
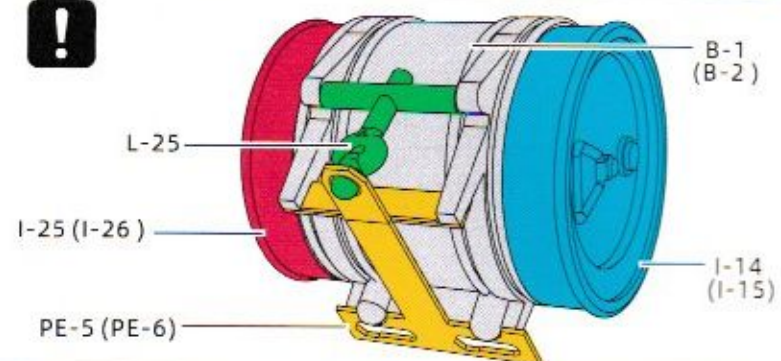







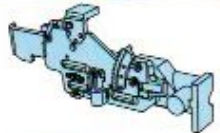
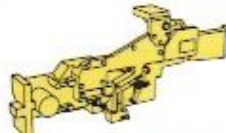

Before installing the small parts on both sides of the turret, please read the painting instructions and choose your scheme. Some painting schemes may require you to paint the turret first, apply decals, and finally install these small parts (it is recommended to paint these small parts separately before installation).

**!** 安装炮塔各侧面小零件之前，请先阅读涂装说明并选定您的方案，部分涂装方案可能要求先对炮塔上色，再贴水上贴纸，最后再安装这些小零件（建议安装前对这些小零件先单独上色）。







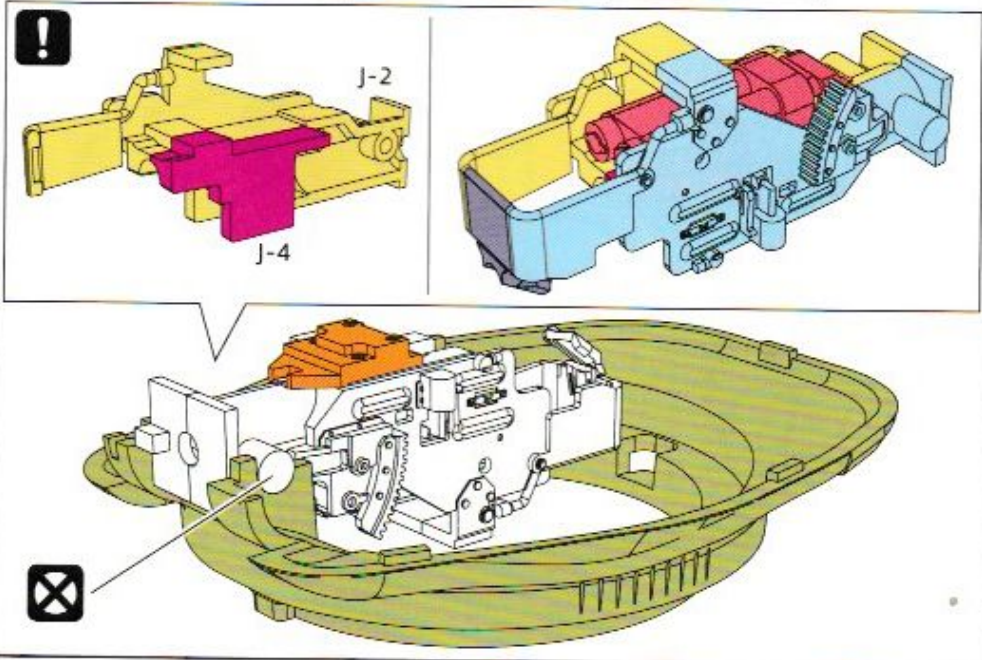

砲塔の両側に小さな部品を取り付ける前に、塗装の説明書を読み、スキームを選んでください。一部の塗装スキームでは、まず砲塔に塗装を施し、次にデカールを貼り、最後に小さな部品を取り付ける必要があります（これらの小さな部品を取り付ける前に別々に塗装することをお勧めします）。

19

			
J-1 X 1	J-2 X 1	J-5 X 1	J-6 X 1
			
D-1 X 1	J-3 X 1	J-4 X 1	







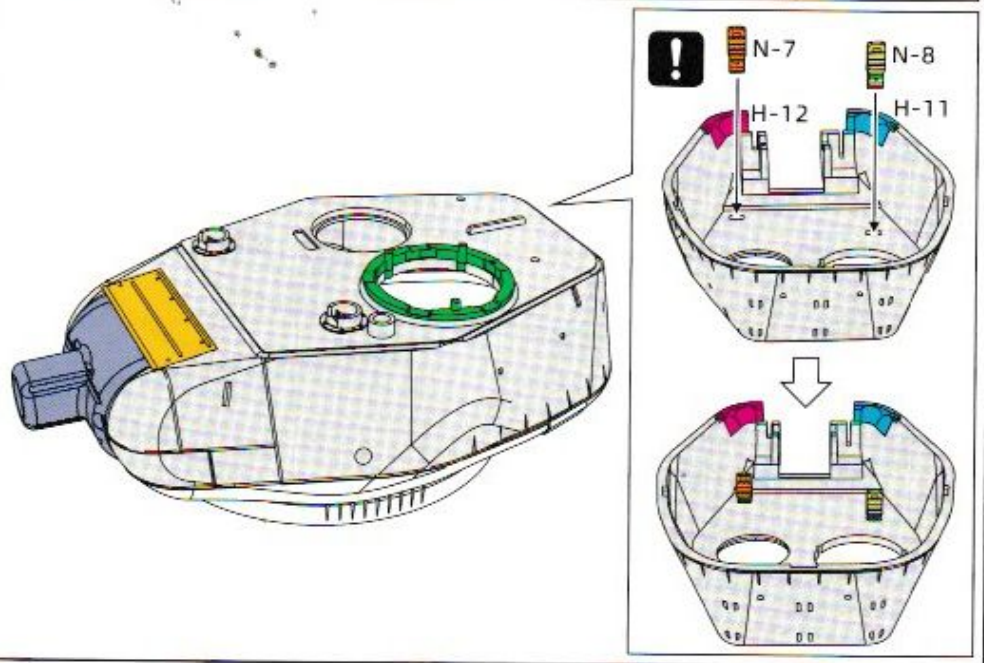



20

				
C-1 X 1	H-12 X 1	H-11 X 1	N-7 X 1	N-8 X 1
				
PE-2 X 1	K-1 X 1	H-7 X 1	H-10 X 1	

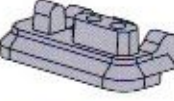



						
L-4 X 2	L-8 X 2	H-30 X 1	H-9 X 1	H-13 X 1	L-5 X 2	N-1(N-2/N-3/N-4/N-5) X 1

	
PE-14 X 1	PE-15 X 1

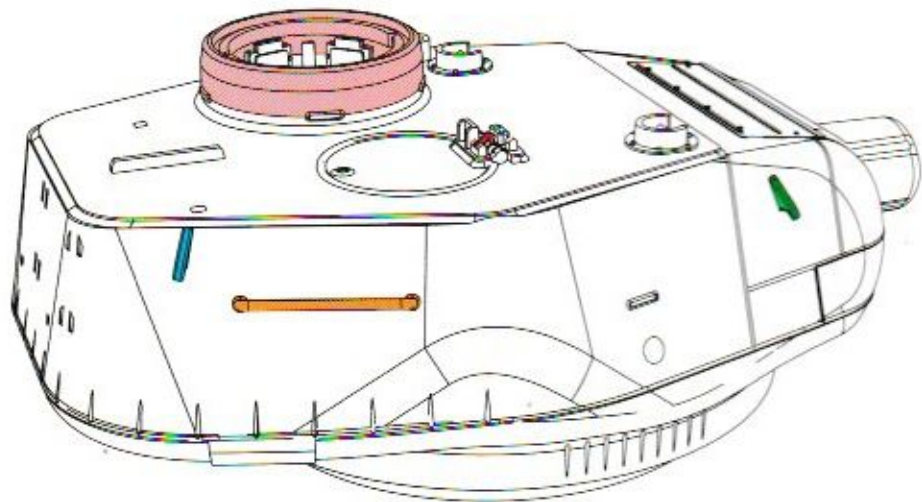
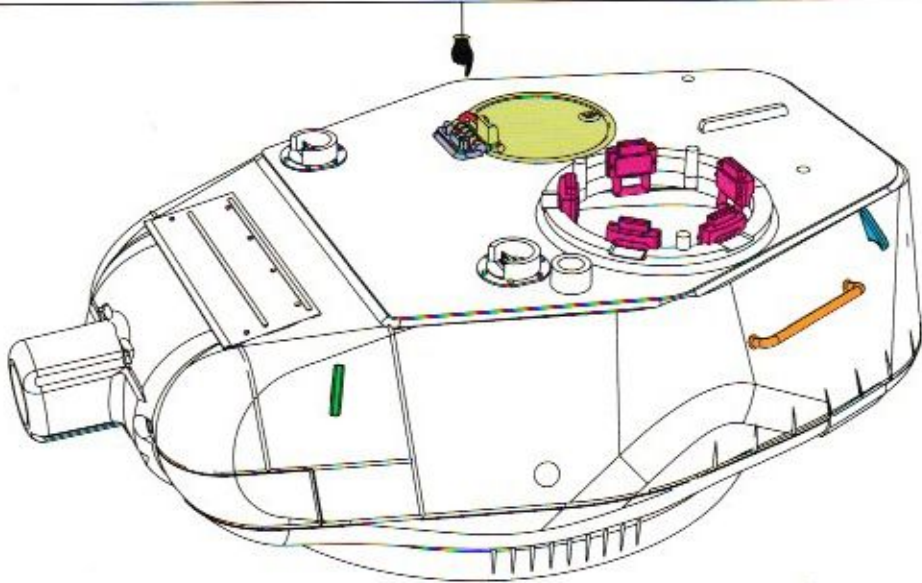
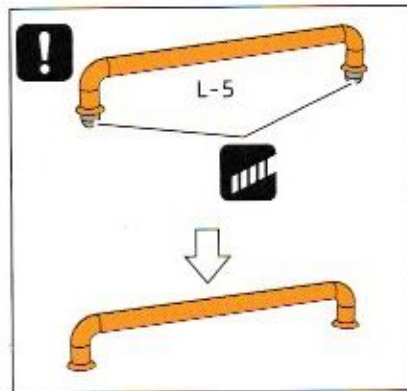
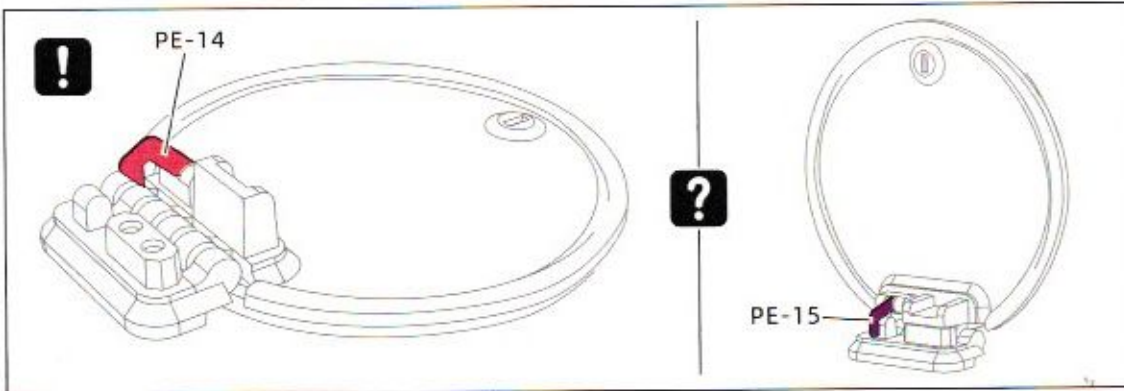



22

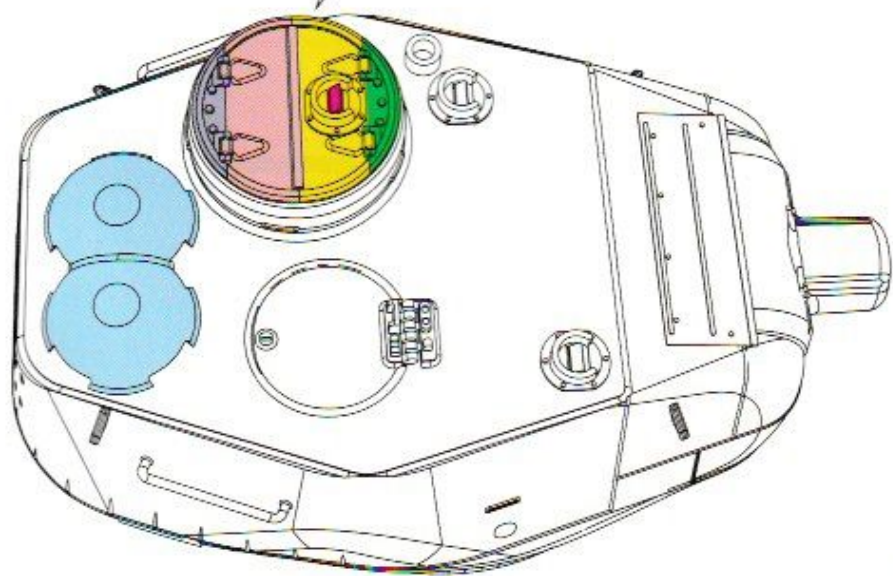
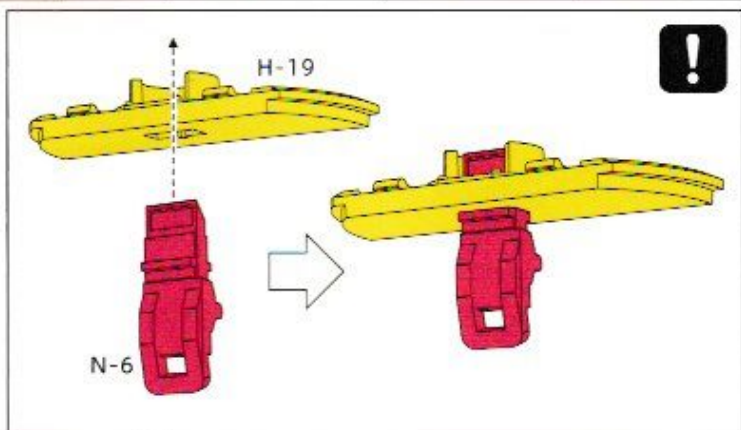
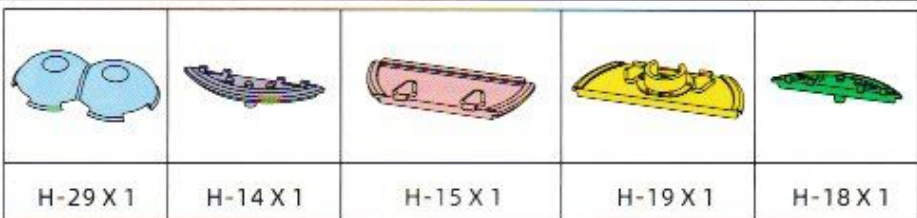

23

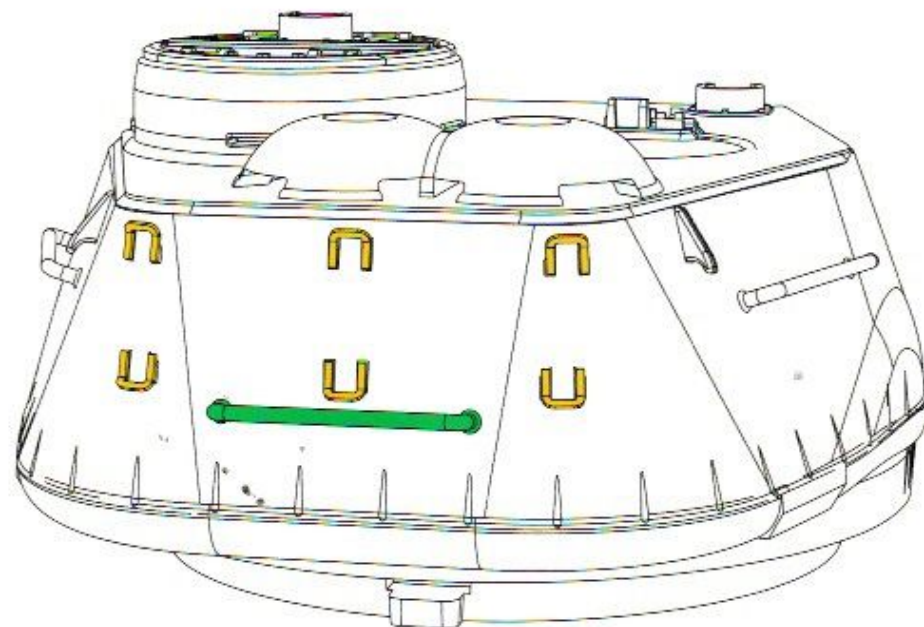
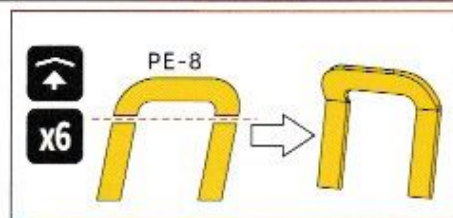
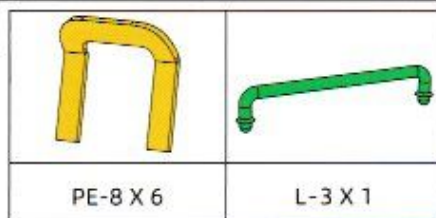

24

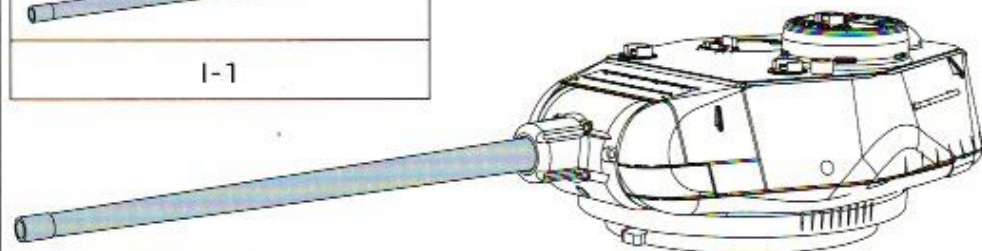
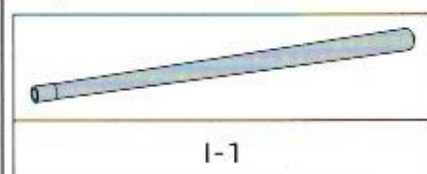

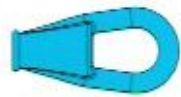

	
纜绳 X 2	L-17(L-20) X 2

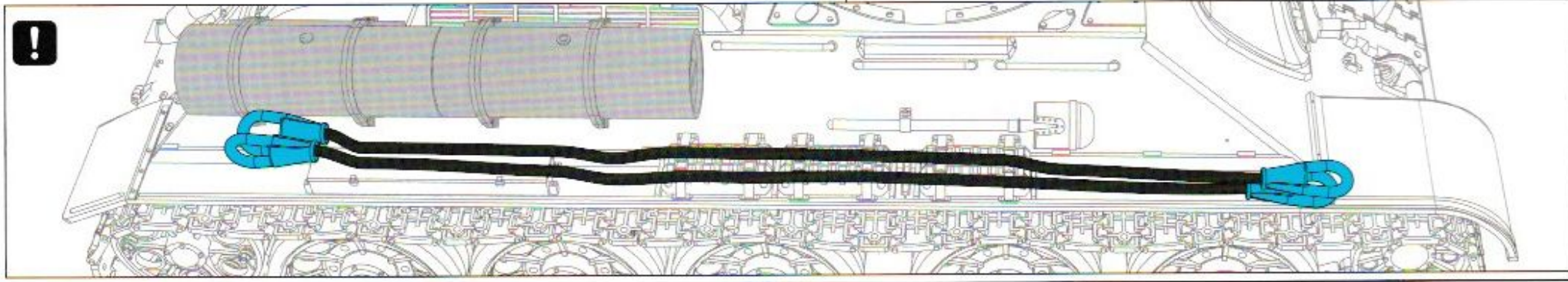
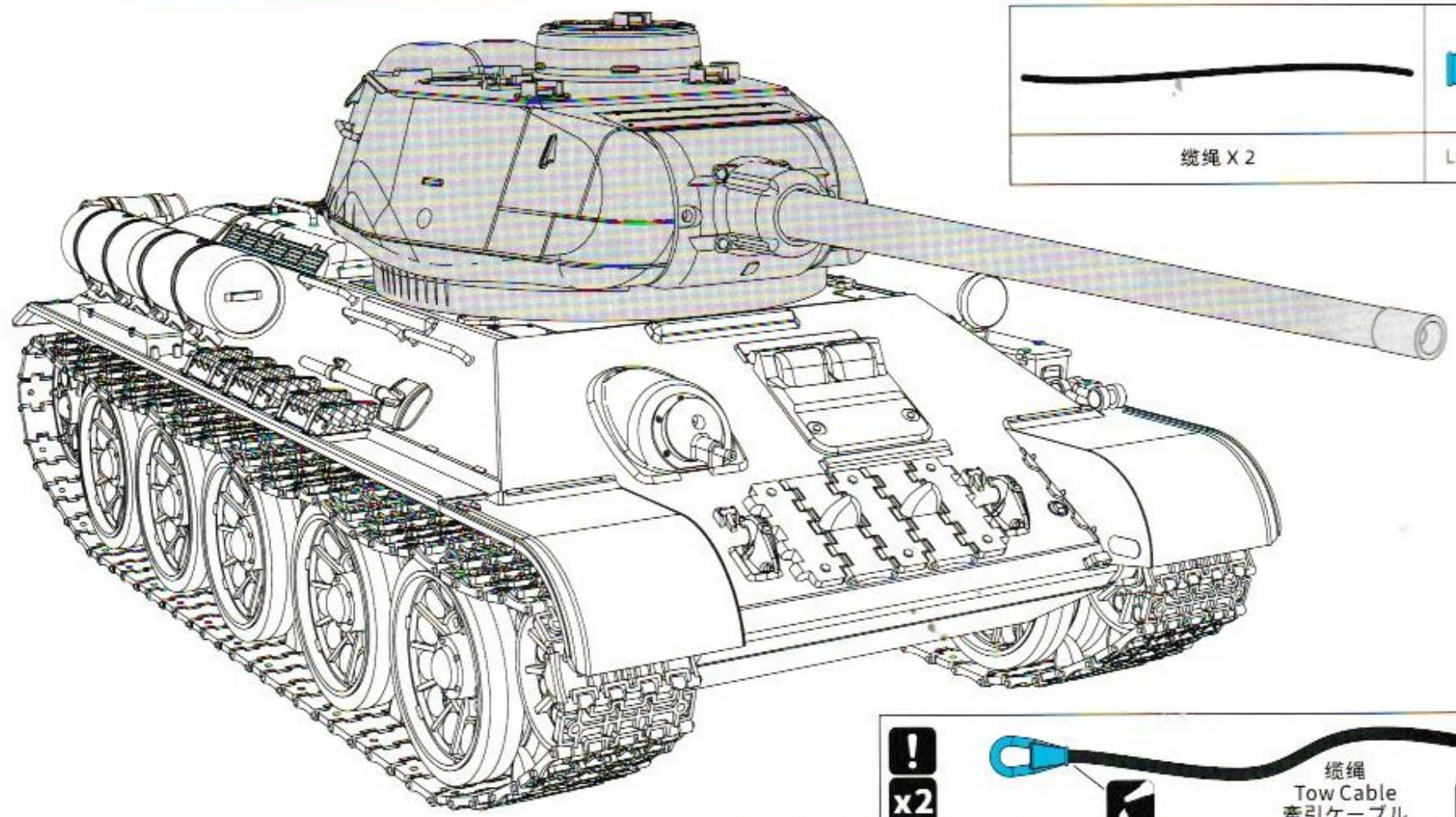



## PAINTING & MARKING GUIDE

### Decal Application:

1. Cut the pictures from sheet as needed.
2. Dip the pictures in warm water for about 10 seconds.
3. Hold the picture backing sheet edge and gently slide the picture onto the model.
4. Please move the picture to the proper position on model.
5. Please gently press picture down with a soft cloth until excess water's out and no air bubbles.

### 塗装与标贴指示













#### 水贴纸的使用:

1. 从水贴纸上剪下图案;
2. 将图案放入温水中浸泡10秒;
3. 拿著图案纸板将图案移到模型上;
4. 将图案移到适当的位置;
5. 用软布轻压图案直至水干,消除掉气泡。

### 塗装とラベリングの指示

#### デカールの使用方法:

1. デカールから图案を切ります。
2. 图案を温かい水の中で10秒浸します。
3. 图案のボール紙を使って、图案を模型に移動します。
4. 图案を適当な位置に移動してください。
5. 柔らかい布で水が乾燥するまで图案を押さえて、気泡を消します。

	Color	颜色	色	Mr.Hobby	Tamiya
	Body Color	车体色	車体色	H  136	XF-61
	Red Brown	红棕色	レッドブラウン	H  47 41	XF-64
	Rubber Black	轮胎黑色	ラバーブラック	H  137	XF-85
	Steel	黑铁色	スチール	H  78	XF-84
	Gun Metal	枪金属色	ガンメタル	H  28	X-10
	White	白色	ホワイト	H  1 1	X-2





January-February, 1945 East Prussia

1945年1-2月, 东普鲁士

1945年1~2月 東プロシア

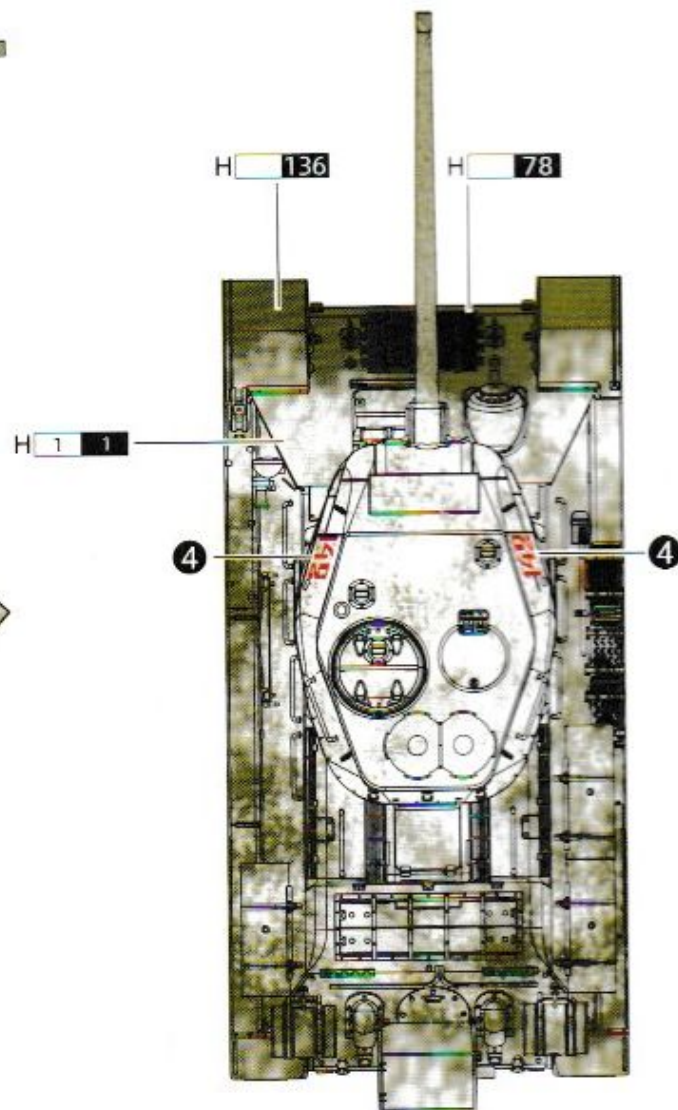
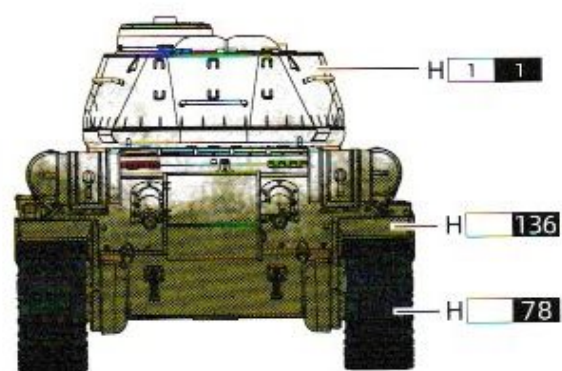
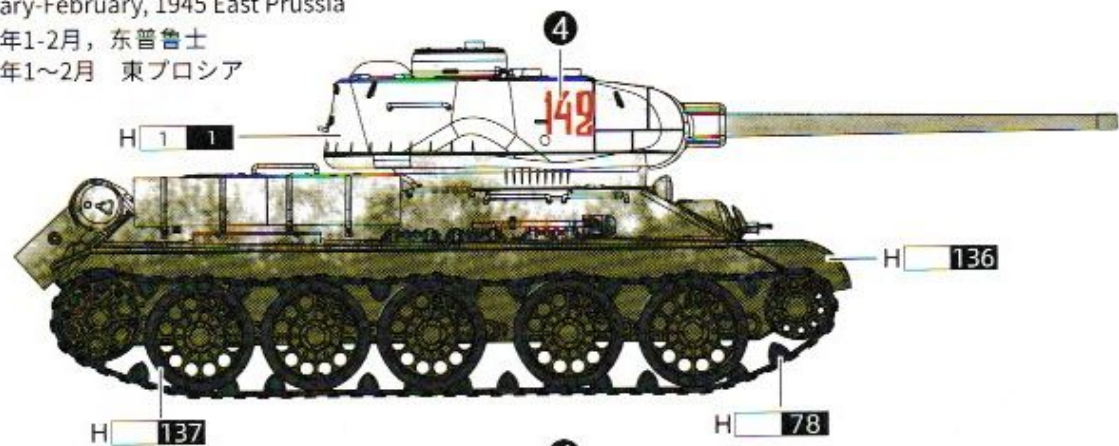



★ April-May, 1945 Fortress of Breslau  
 1945年4-5月, 布雷斯劳要塞  
 1945年4~5月 プレスラウ要塞

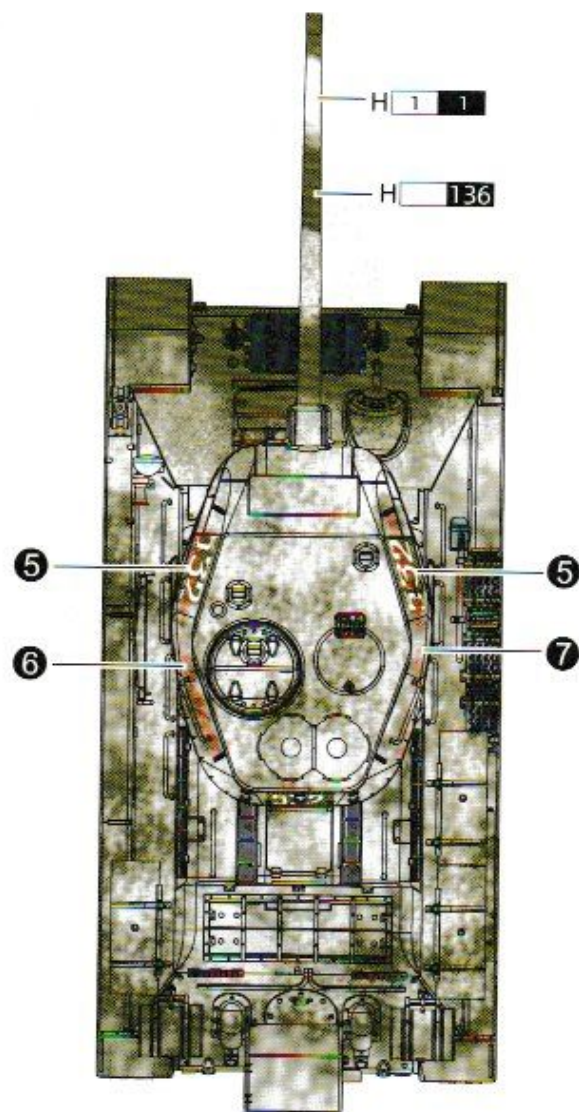





March, 1945 Pomorania  
1945年3月，波美拉尼亚  
1945年3月 ポメラニア

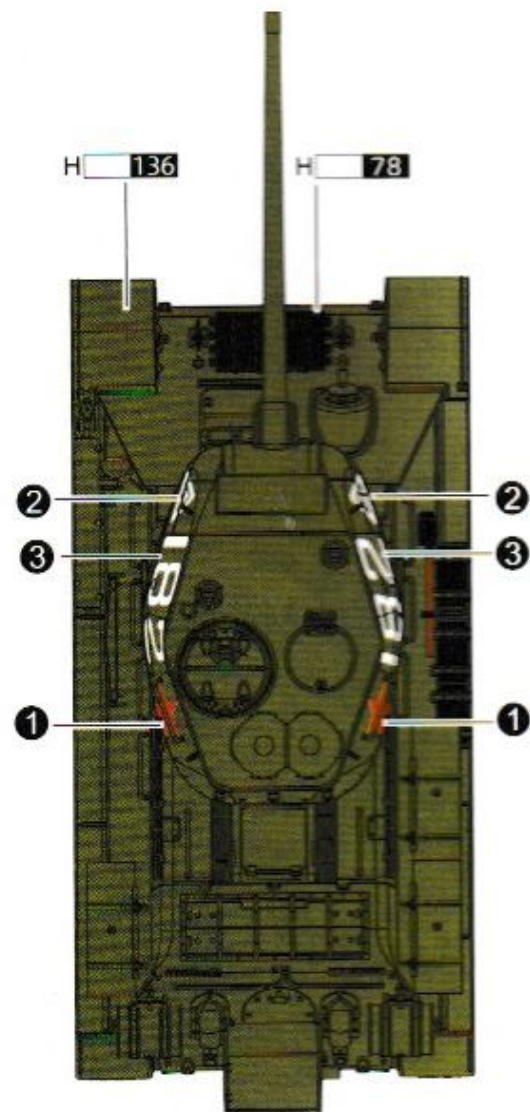



★ April, 1945 Germany  
1945年4月, 德国  
1945年4月 ドイツ

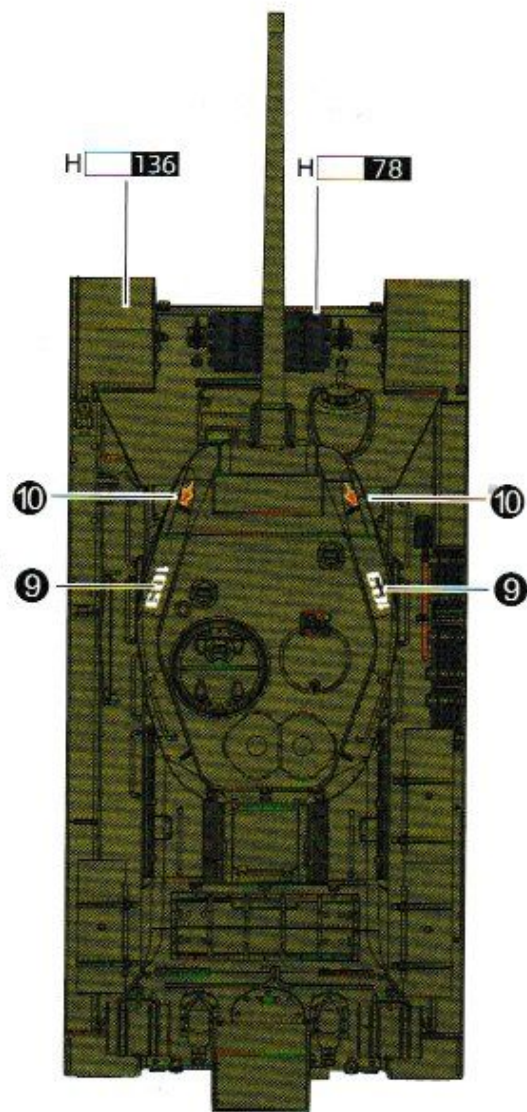
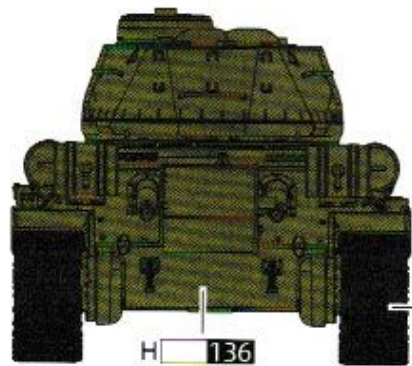
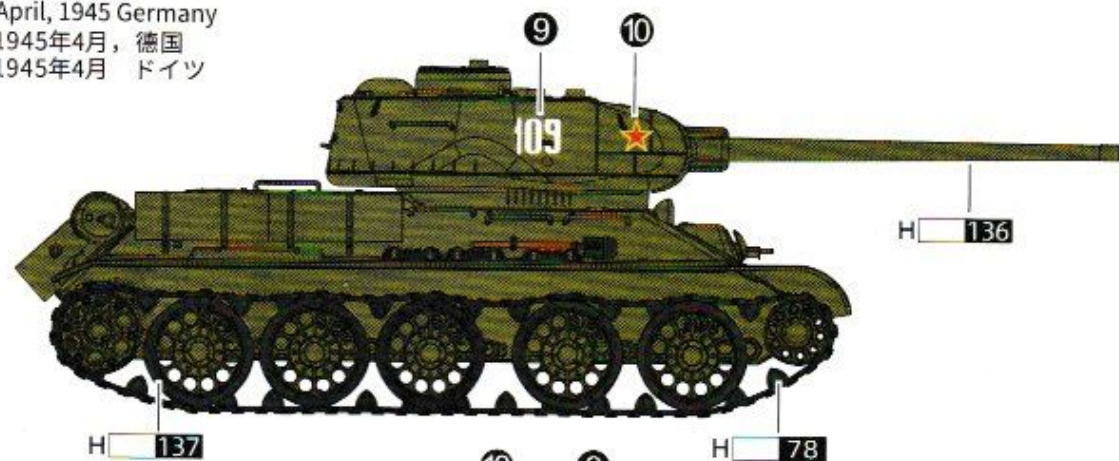





April-May, 1945 Germany  
1945年4-5月, 德国  
1945年4~5月 ドイツ

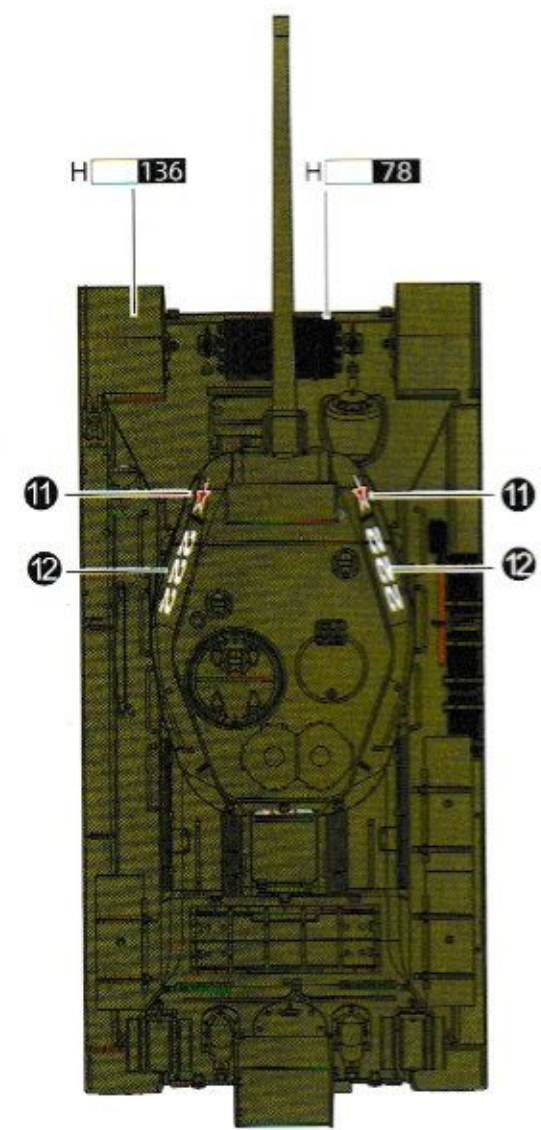
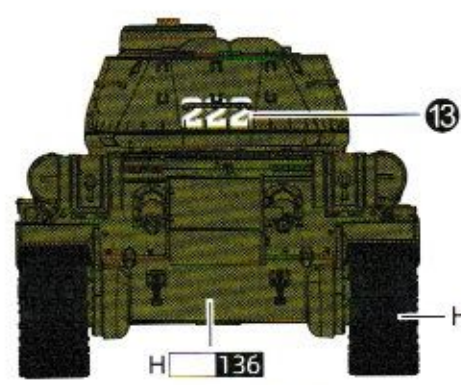
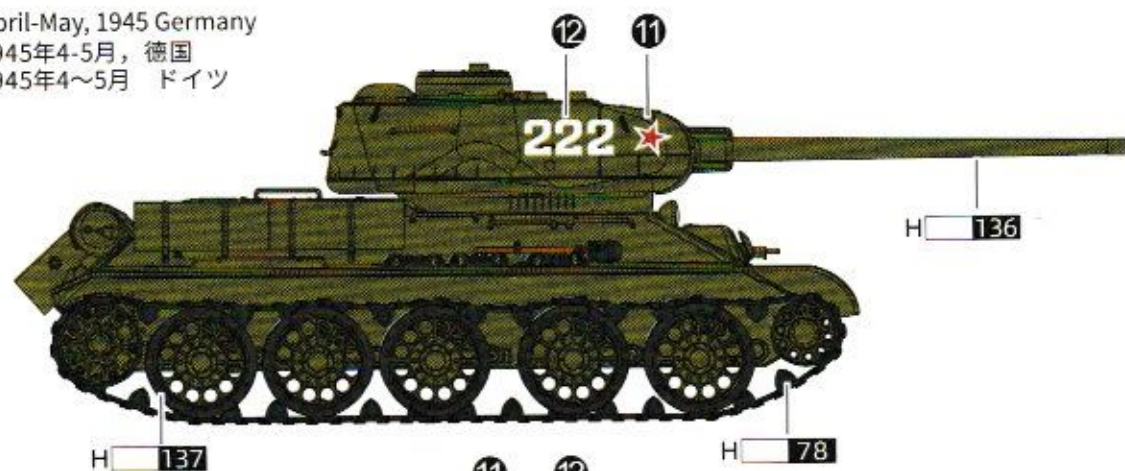



★ Unknown Unit, 1944 Summer  
 所属部队未知, 1944年夏  
 所属部队不明 1944年夏

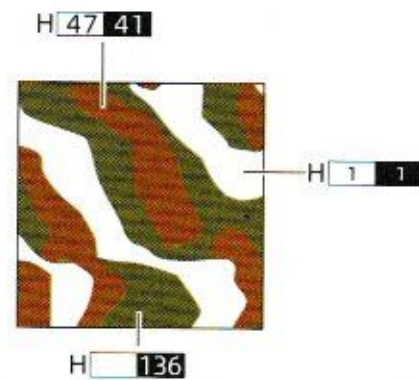
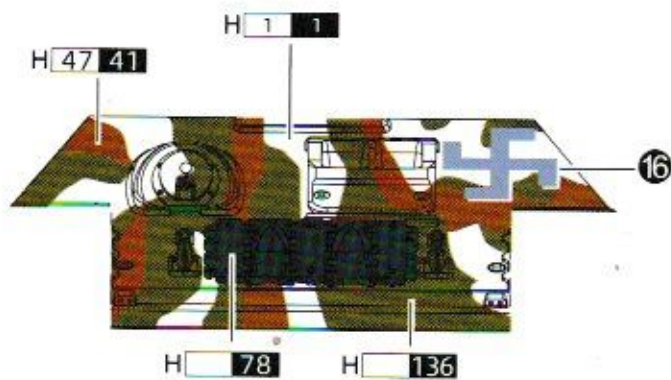
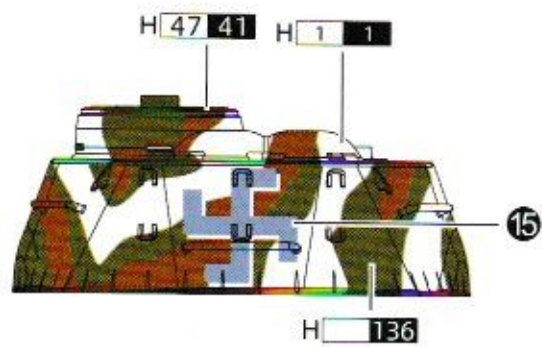
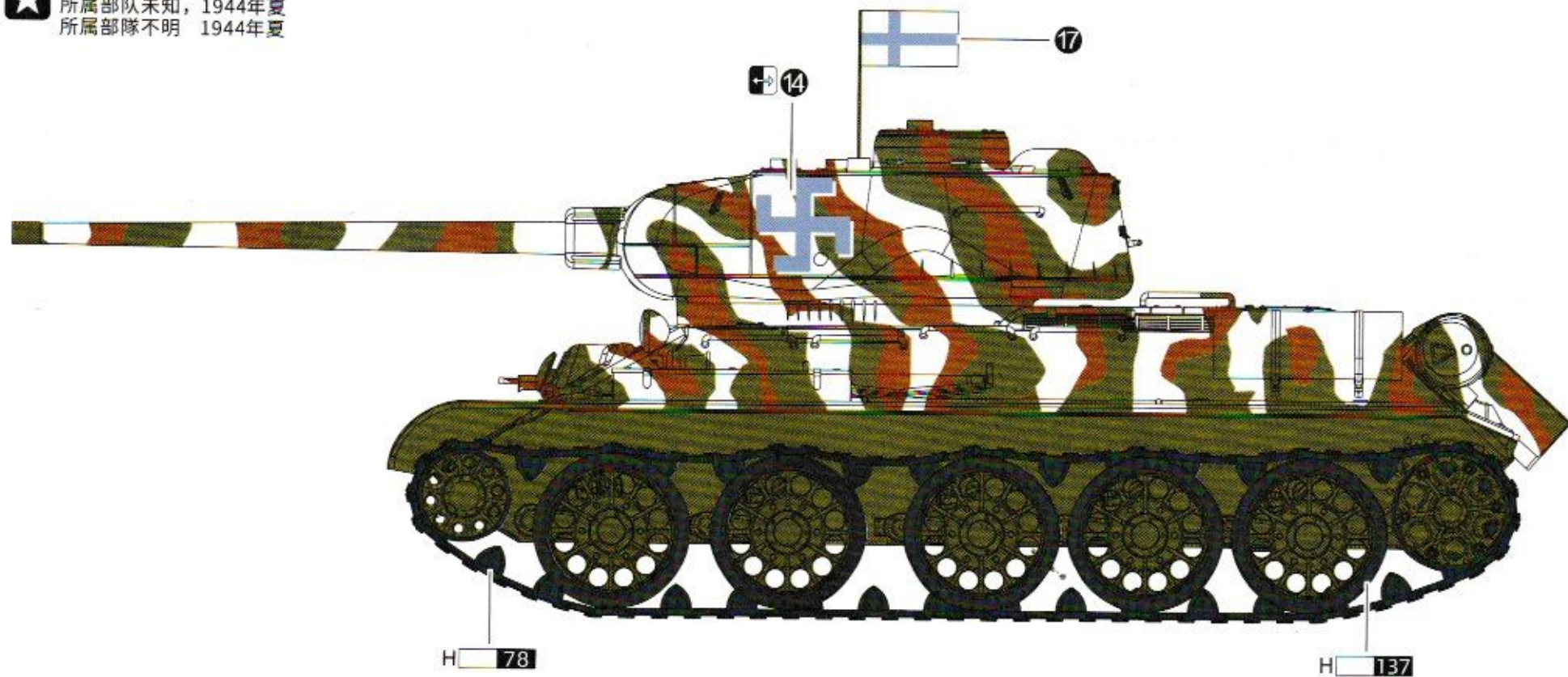





1/72  
FH 3003

Pz.Kpfw II Ausf L Luchs  
W/Zusatzpanzerung  
山猫坦克附加装甲型



1/72  
FH 3005

Pz.Kpfw II Ausf J (VK16.01)  
德国2号坦克J型 (VK16.01)

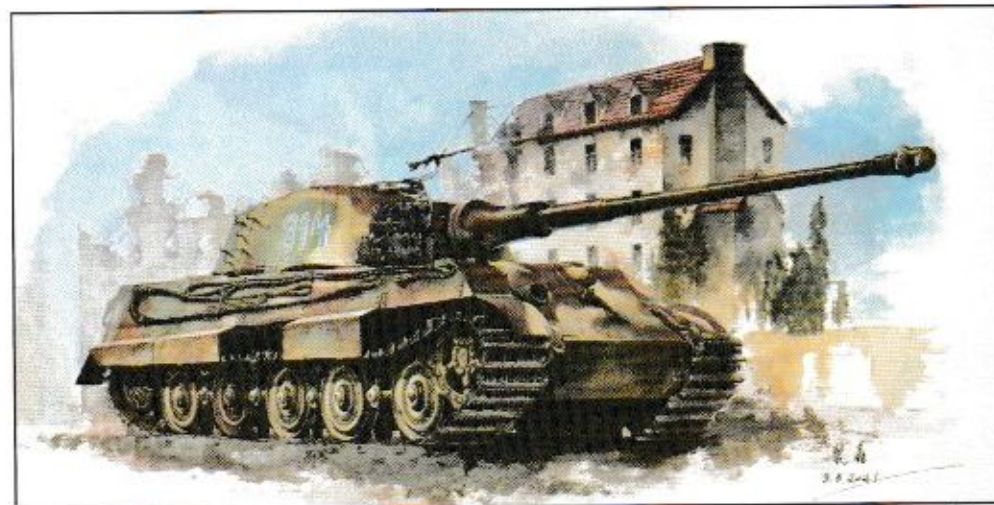

1/72  
FH 3019

Pz.Kpfw.VI Ausf.B  
KÖNIGSTIGER  
CONVENTIONAL VERSION  
德国虎王坦克 (亨舍尔炮塔型)



1/72  
FH 3302

M1A1 Main Battle Tank  
M1A1 主战坦克