

IAF AH-64D-I 'SARAF' - 1/48 scale

For Hasegawa AH-64D kits

WMF48016



www.wingmanmodels.com

Resin Parts

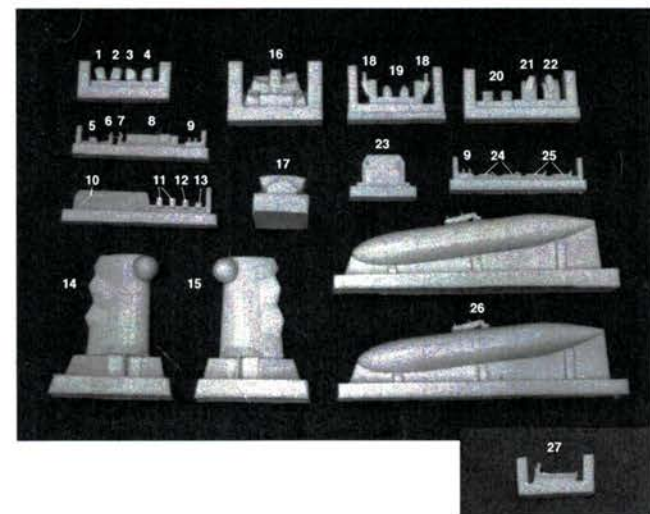
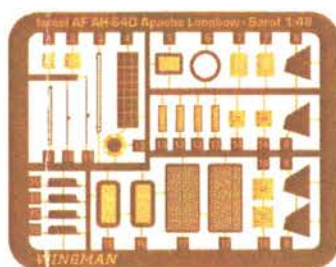

Photo Etch Parts



Decals



This set contains resin and photo-etch parts. Use them carefully and follow the instructions step by step. The set fits the Hasegawa AH-64D Apache Longbow. The steps in our instructions follow Hasegawa's instructions.

Use Cyanoacrylate glue to attach the photo-etch and resin parts.

The (*) mark will refer to the numbers of the photo-etch parts.

Assembly

Steps 1-3

Install parts # 16 & 8 instead of kit's parts D32 & D16. Attach parts #6 & #7 to part #16.

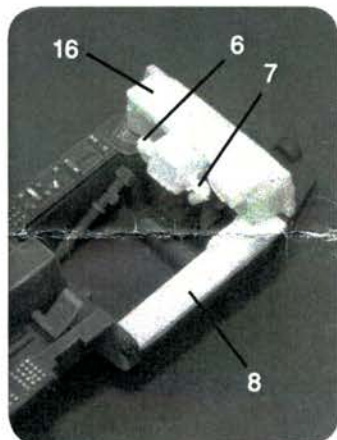

Install part #23 and attach parts #24 and #25 to it.

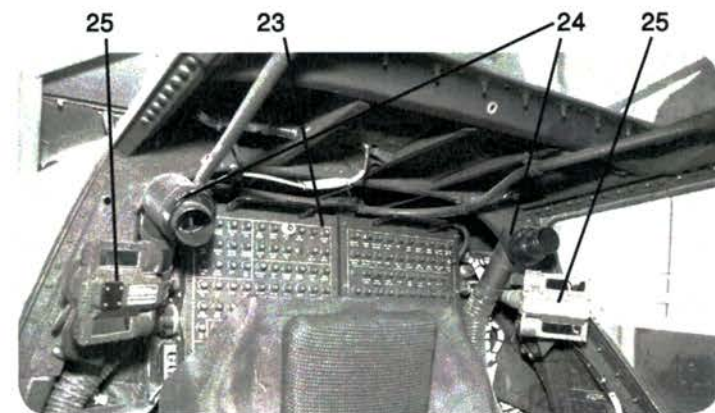
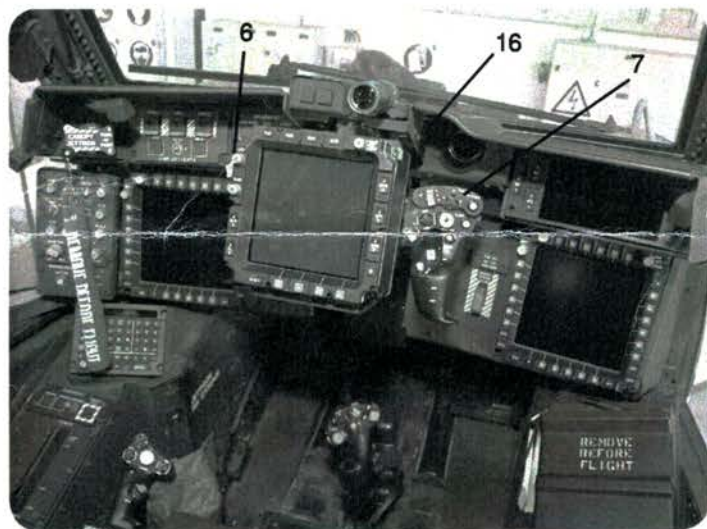
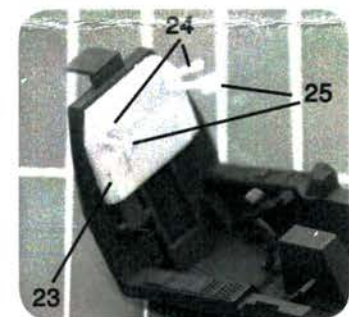

Step 4

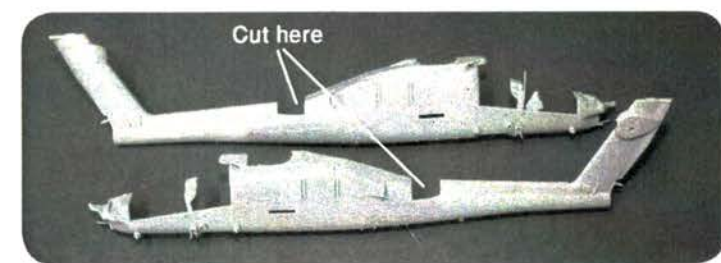

Do not drill the holes in the fuselage except the one on the rear, right side cockpit. Cut the panels from both fuselage parts as seen in the photos.



Step 5

Replace kit part A3, A4, B2 and B3 with our parts #14 & #15. Attach part D9 and D8 from the kit to the set wings.



Step 6

Install cockpit parts excluding parts G44 and G25. Attach part #5 as seen in the photos. Glue parts #18 to the bottom of the wings as shown in the picture below.

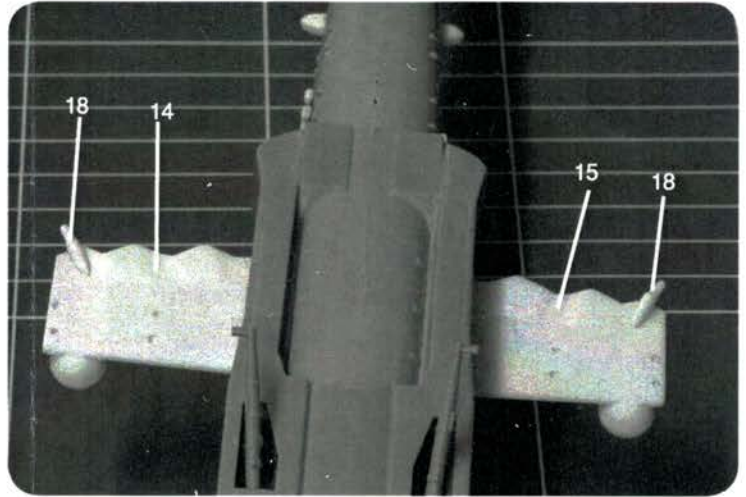

Steps 7-8

Assemble the landing gear as shown in the kit. Before attaching parts D2 and D3, drill and file the screen parts on the rear section. Cut part D3 as shown in the picture. This will allow you to sleek in the parts on the wing.

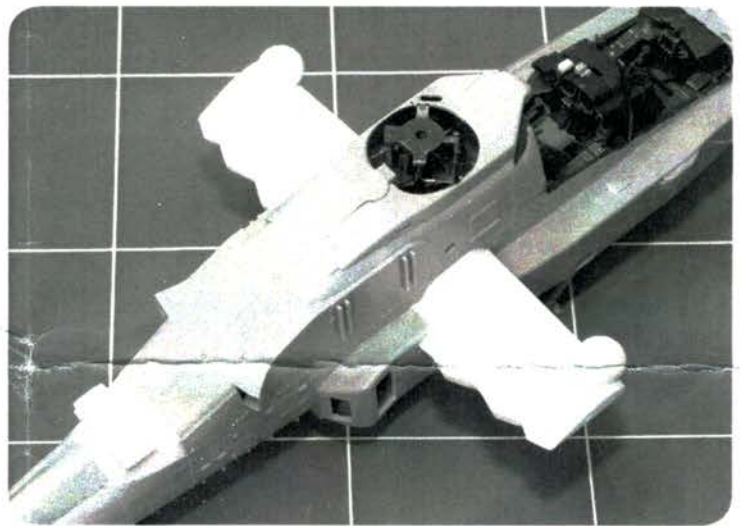
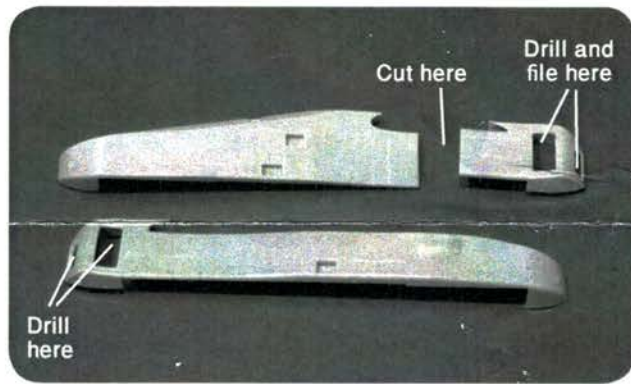

Step 9

Assemble the engines. Cut out the two square panels on the bottom side of the engines and attach photo-etch parts #15 and #19. Attach parts #22 & #21 instead of kit parts C8 & C9. Attach parts #1 & #2, glue parts #20 on them and attach photo-etch parts on top of them. Assemble parts #9 as well. Parts D24 and D25 are not in use.

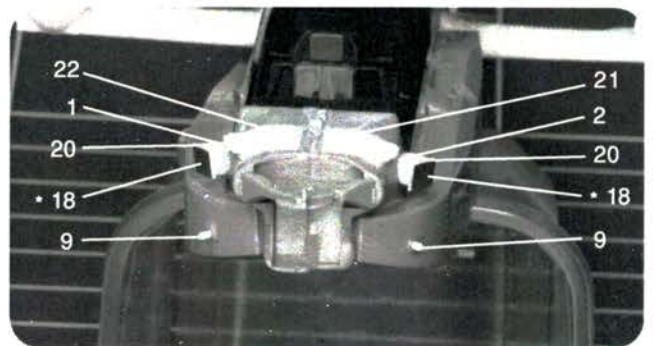
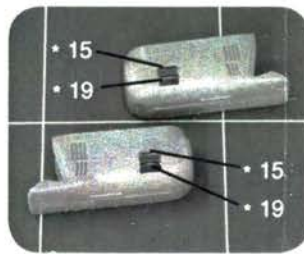

For better painting results, paint the engines and fuselage separately and only than assemble them together.

Step 10

Assemble according to the kit's instructions.

Step 11

Do not use part J37 when doing a Saraf. Install part #17.

Step 12

Assemble according to the kit's instructions.

Step 13

Do not use parts J14 and J18. Use Photo-etch parts number *3, *9, *10 and *11 according to the drawing on the right. It's better to assemble these parts after painting the model. Paint the parts in black.

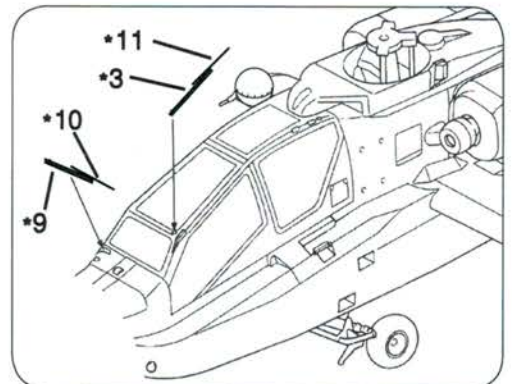

Step 14

Assemble according to the kit's instructions. Add resin parts #11, #13 (left side), #12 (right side) on top of photo-etch parts *1, *2 & *7. Attach photo-etch parts *13 according to the photos. Assemble parts #19, #3, #4 & #10 as well.

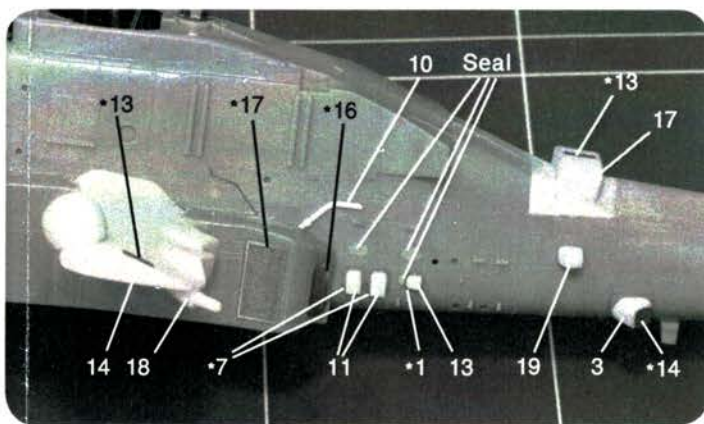

Steps 15-16

Assemble according to the kit's instructions.

Steps 23-25

The IAF do not have the FFAR - Folding-Fin Aerial Rocket in use. Because of that, DO NOT assemble kit's parts F18 to the inner pylons - parts L3 & L4. Attach the two external fuel tanks (parts #26) to these pylons after attaching the etch fins (parts *8) as seen in the picture. Build the ALQ-144 jammer from the *4, *6 and *12 etch parts and install it instead of parts Q1, Q2 and Q3.

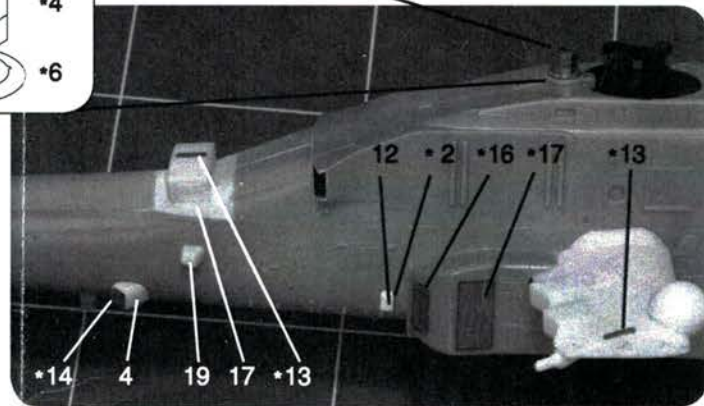
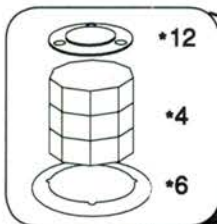

Steps 17-22

Sand and remove the base for the chaff/flare dispenser on the fuselage. Parts J35, F26 and G8 are not in use.

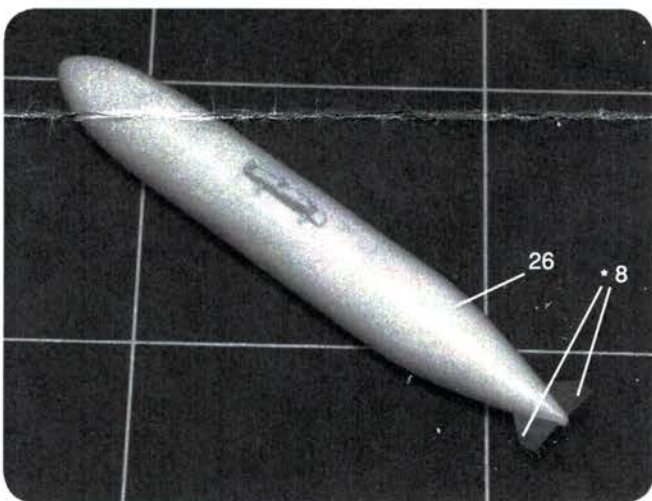

Step 26

Use photo-etch part *5 instead of kit's part G2. Attach parts #9 as seen in the photo on the right.

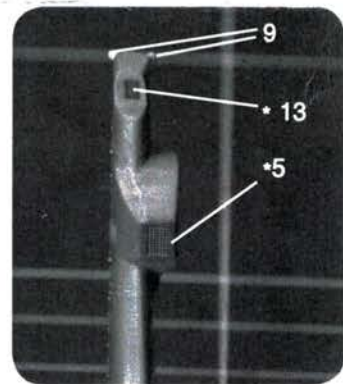

Use the pattern near part #10 to make these parts from thin plastic rods.

On the final step add part #27 according to the photos.

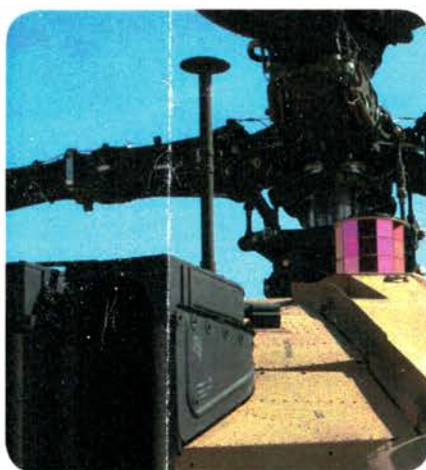
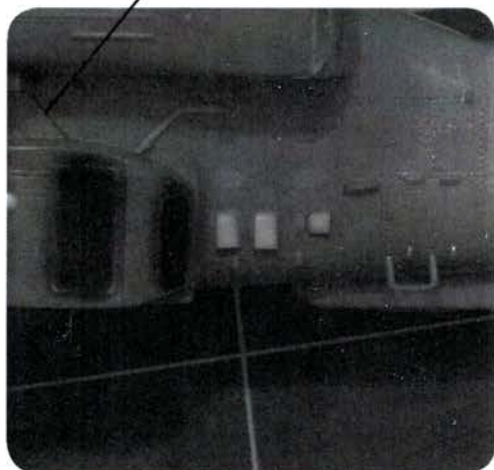

Painting Guide



Brown FS 30219
(Humbrol 118)

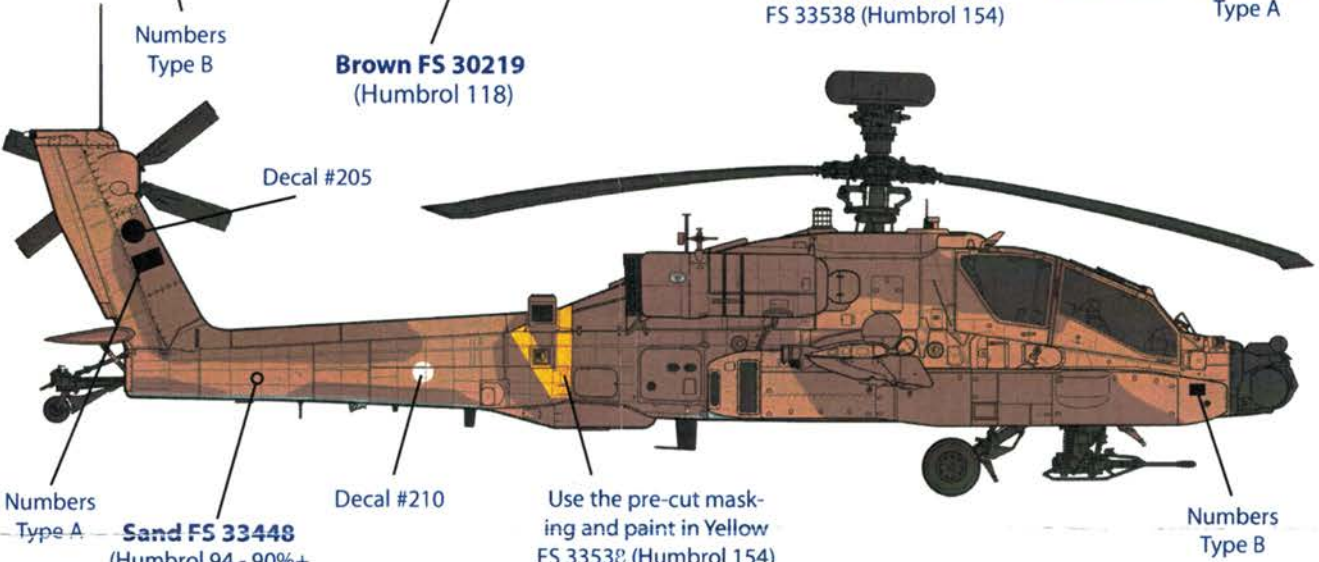

Sand FS 33448
(Humbrol 94 - 90%+
Humbrol 34 - 10%)

Drab FS 34031
(Humbrol 66)

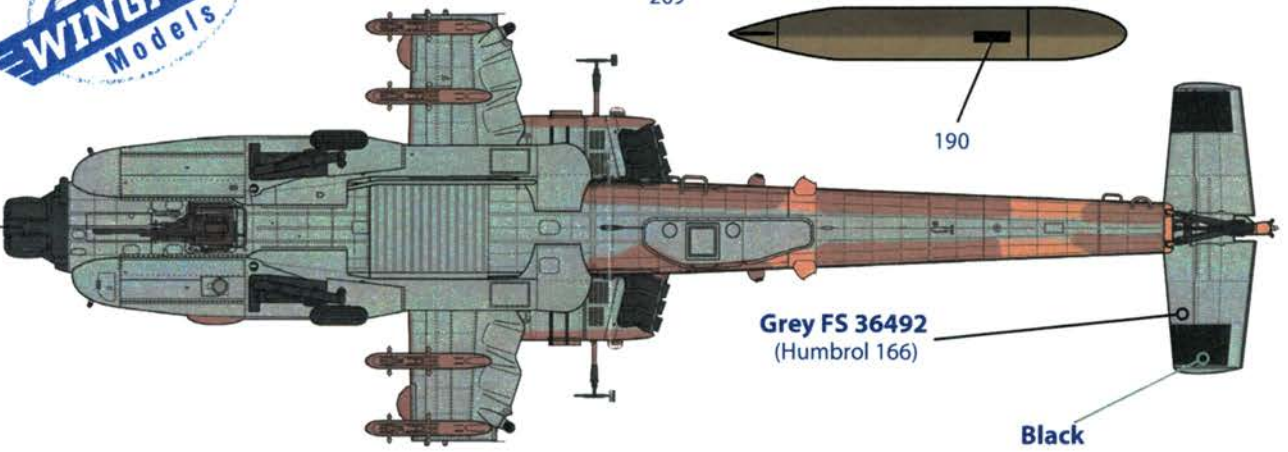
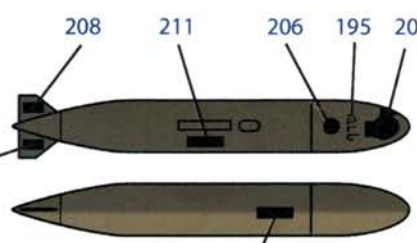
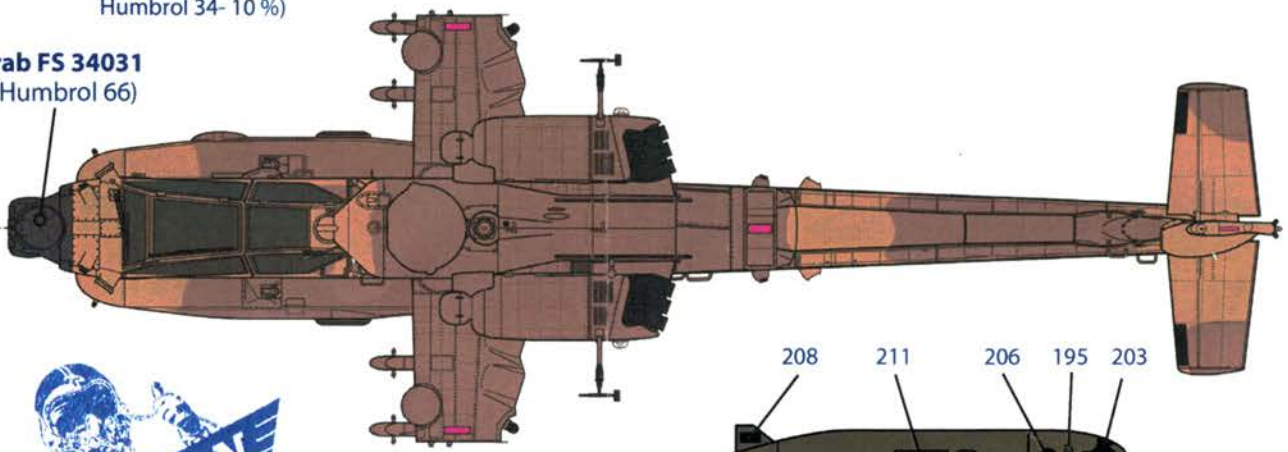

Grey FS 36492
(Humbrol 166)

Black

